

Monthly adventure role-playing aid

# Dragon

\$3.50

# 116

The High Seas  
(and a 3-D sailing ship)  
Wild animals  
Doctor Who? (all six!)



0-88056376-3



0



# The Quest Continues...

TALISMAN, the classic fantasy boardgame, is back in a stunning second edition - now with full-colour cards to create even more atmosphere for adventurers everywhere.

And available at last to all TALISMAN addicts - the TALISMAN EXPANSION SET. More characters, spells, objects and events to make TALISMAN even more of a challenge. Seventy new cards altogether, plus a FREE poster of the fantastic new cover artwork!

# TALISMAN

TALISMAN and the TALISMAN EXPANSION SET from GAMES WORKSHOP.  
Available now from all good games shops, or send SAE for full mail order details to:  
Games Workshop/Citadel Miniatures Mail Order, Chewton St, Hilltop, Eastwood, Notts, UK;  
or: Games Workshop US, 9110F Red Branch Rd, Columbia, MD21045, USA.



# Christmas

RELEASES FROM IRON CROWN ENTERPRISES

## ROBOT WARRIORS

The latest from Hero Games. This Role Playing and Battle Game features giant humanoid combat robots! Take the part of a Robot Pilot and direct your hundred ton robot through the scarred battlefields of a future earth!

©Copyright 1986 Hero Games

## LORDS OF MIDDLE-EARTH

Imagine having at your fingertips the personalities and game statistics of the greatest and most powerful beings of Professor Tolkien's creation! This first volume of a three part series details the Immortals: the Elves, Maiar, and Valar.

©Copyright 1986 Tolkien Enterprises



## ADVENTURERS CLUB

THE HERO GAMES, IRON CROWN QUARTERLY

AC#8 has been expanded to 72 pages! The new format features a new I.C.E. section as well as the regular Hero articles and scenarios. The new Adventurer's Club Magazine is a must for I.C.E. devotees as well as Hero fans!

## Rolemaster Companion

The classic FRP system is expanded with optional rules and guidelines. New high-level spells and spell lists! More creatures! New character classes and new races! The ROLEMASTER COMPANION... the best roleplaying system gets even better!

©Copyright 1986 I.C.E.

IRON CROWN ENTERPRISES / P.O. BOX 1605 / CHARLOTTESVILLE, VA 22902

PLEASE RUSH ME: (U.S. \$)

<input type="checkbox"/> LORDS OF MIDDLE EARTH (VOL 1) . . . . .	12. <sup>00</sup>	NAME _____
<input type="checkbox"/> ROBOT WARRIORS . . . . .	15. <sup>00</sup>	STREET _____
<input type="checkbox"/> ROLEMASTER COMPANION . . . . .	12. <sup>00</sup>	CITY _____ STATE _____ ZIP _____
<input type="checkbox"/> ADVENTURER'S CLUB #8 . . . . .	3. <sup>00</sup>	PHONE # _____
<input type="checkbox"/> 1 YEAR SUBSCRIPTION TO ADVENTURER'S CLUB . . . . .	10. <sup>00</sup>	

Orders up to \$49.95 add \$1.25 postage & handling, orders of \$50.00 or more add \$2.50. Canadians add (U.S.) \$2.50 on all orders. Send check or money order, no cash or COD. VISA & MASTERCARD orders call (800) 325-0479. VA residents, Canadians & overseas customers call (804) 295-3917. Please make phone orders during normal business hours 9AM-5PM, Eastern Standard Time, Mon.-Fri.

# Dragon<sup>®</sup>

Magazine

Issue #116  
Vol. XI, No. 7  
December 1986

*Publisher*  
Mike Cook

*Editor*  
Roger E. Moore

*Assistant editor*  
Robin Jenkins

*Fiction editor*  
Patrick Lucien  
Price

*Editorial assistants*  
Marilyn Favaro  
Eileen Lucas  
Georgia Moore  
Debbie Poutsch

*Art director*  
Roger Raupp

*Production staff*  
Linda Bakk  
Betty Elmore  
Gloria Habriga  
Kim Lindau  
Carolyn Vanderbilt

*Advertising*  
Mary Parkinson

*Subscriptions*  
Pat Schulz

*Creative editors*  
Ed Greenwood  
Jeff Grubb

*Contributing artists*  
Peter Botsis  
Roger Raupp  
David Trampier  
James A. Gollata  
Robert Maurus  
Bruce Simpson  
Diesel  
Francis Mao  
Marvel Bullpen  
Sue Weller  
Jim Holloway  
Larry Elmore  
Dennis Kauth  
Wendi Pini  
Joseph Pillsbury  
Mark Saunders  
Gustave Doré  
Cosmic Comics  
Lawrence Raimonda



# CONTENTS

## SPECIAL ATTRACTION

- 9 **MARITIME ADVENTURES:** Oceans of gaming information
- 10 **High Seas** – Margaret M. Foy  
Ships, from life boats to the glorious tall sails
- 28 **Children of the Deep** – Todd Mossburg  
Aquatic elves in the AD&D® game
- 38 **The Dragon's Bestiary**  
Marine life – as the readers imagine it
- 46 **"Hello, Your Majesty?"** – Craig Barrett  
By ship or by pigeon, the mail must go through
- 52 **High Seas in 3-D** – Dennis Kauth  
A 25-mm sailing craft for maritime quests

## OTHER FEATURES

- 32 **The Ecology of the Minotaur** – Anthony Gerard  
The unusual tale of a lone survivor
- 36 **Readers' Surprise** – James A. Gollata  
Our favorite double take of the month
- 54 **Rogue Stones and Gemjumping** – Ed Greenwood  
The perfect holiday gift for trouble-prone mages
- 58 **By Tooth and Claw** – Gregory W. Detwiler  
Never laugh at hyaenas, and other wild advice
- 66 **High Ones, Ancient Ones** – Michael DeWolfe and Galan Akin  
Playing High Ones in the ELFQUEST® game world
- 69 **The Role of Computers** – Hartley and Pattie Lesser  
*Dragonfire II* and *Bard's Tale* pass the test
- 80 **The Marvel®-Phile** – Jeff Grubb  
Don't get caught in the Crossfire™
- 84 **Doctor Who?** – Margaret Weis and Michael P. Bledsoe  
A six-in-one special for FASA's DOCTOR WHO game
- so **Aim and Burn** – William A. Barton  
Fanning the fires in TRAVELLER® games

## DEPARTMENTS

- |                      |                        |                 |
|----------------------|------------------------|-----------------|
| 3 Letters            | 78 TSR Previews        | 97 Snarfquest   |
| 4 World Gamers Guide | 94 Gamer's Guide       | 100 Dragonmirth |
| 6 Forum              | 96 Convention calendar | 102 Wormy       |

## COVER

Some time ago, we received an unusual set of pictures in the mail. Peter J. Botsis, of Rochester, NY, created a scratch-built red dragon in its lair, complete with gold coins and the remains of several treasure hunters. Sue Weller photographed it; the sculpture is actually several feet long. We immediately decided it was perfect for a December cover ("Rangers roasting on an open fire . . .")



# LETTERS

## Armor addenda

Dear Dragon,

I would like to commend you on the excellent job you did on the article, "Armor, piece by piece" (issue #112); but I have one question. Wouldn't it be coherent to have separate hit points for each part of the body? For example, shouldn't the chest be able to take more damage than a foot? Also, a person cannot be killed by being hit in the elbow, as the current hit point system would suggest. I think a separate hit point system would be realistic if you use the hit location chart.

James Goldberg  
Phoenixville, PA

Though Mart Bandy did not include a system for calculating the hit points of individual parts of the body, he did have a system that took this question into account. Because of space limitations, the following material was dropped from the original article; we present it now (as Matt had intended) for use as a set of optional rules for his partial-armor system. — RM

**Damage modifiers:** Damage is modified as to hit location as illustrated on the following table. These modifications result from each area's importance in maintaining life processes.

Body part	Damage modification
Head	+3
Neck	+3
Chest	+2
Abdomen	+1
Hand	-1
Foot	-1

**Called strikes:** A combatant may attempt to strike a specific area of his opponent's body, rather than stabbing at any opening that appears. In this case, the hit-location roll is bypassed and a -2 penalty to hit is incurred. If the attack is successful, the desired location is hit; if not, no hit is scored. Called strikes may be used to knock a weapon from an opponent's hand, if damage equal to half an opponent's hit points is inflicted on an opponent's weapons arm.

**Selective protection:** A combatant may opt to lend special attention to the protection of one specific body part. If this option is utilized, the armor class of the specially protected body part is bettered by two, while the armor class of the remainder of the body is degraded by one. Also, all attacks made by the defender while protecting selectively are done so at a -2 penalty.

Magical pieces of partial armor are feasible if the DM so desires. Note that magical shields are already accounted for with this system.

It has been said that if the AD&D® game dies, it will be of terminal oversophistication. The

partial armor system adds considerable sophistication to the game's combat system, but it is sophistication of preparation, not of play. The player is urged to write the armor class of each body part of his character on his character sheet, so that this information is readily available in combat.

Monsters, however, are a different matter entirely. DMs who enjoy hours of grueling mental exercise may want to prepare a table giving the armor class of every body part of every monster involved in an adventure [See Alex Curylo's article on this topic in issue #114, page 50, for a much simpler system. — Editor]. Others may simply prefer to guess at values, using the rules put forth in this article as guidelines. Either system is usable, so long as guesses remain reasonable and the armor class tables don't interfere with the continuity of game play. The system adds but a single die roll to combat, and it brings a wealth of realism to the game. — Matt Bandy

## New horizons

Dear Dragon:

I have played the AD&D game in the past but, alas, eventually found most all situations, whether with new characters and/or a new DM, boring. I have moved on to other games now, like the TOP SECRET, TRAVELLER®, and TIMEMASTER™ games. I really enjoyed your magazine; I didn't even mind you raising the prices in the long run, but now I cannot get my money's worth because you really are an 80% AD&D game magazine. I also heard you got rid of the ARES™ Section (I haven't bought an issue since March), so I suppose it's 90% D&D® and AD&D game material. I think you would do much better if you expanded your letters column, while devoting more of the magazine to other games like those mentioned above and other TSR games. I realize there are hundreds of RPGs that you could write about, but if you wrote articles about the top ten or fifteen best-selling RPGs for the past three or four months, you would eventually get a broader reading audience. Of course, I don't mean to tell you how to publish your magazine; DRAGON® Magazine has been around for ten years, so I don't suppose you'd change the format. True, AD&D gaming is the most popular — the father, in fact, of all RPGs ever published — but if it continues to dominate DRAGON Magazine, you should call it the AD&D Monthly Role-Playing Aid. It would be more accurate.

Mark D. Spivey  
LaGrange, IL

Dear Dragon:

I've been subscribing to your magazine since issue #63, and I have most of your issues from #49 and on. You need to start diversifying. It

(Turn to page 56.)

## Potpourri

No particular theme comes to mind for my December editorial, so I'll cover a number of short subjects:

**New arrivals:** The first of our new features, hinted at in last month's editorial, makes its debut (redebuted?) in this issue. "The Dragon's Bestiary" returns with a wild host of reader-submitted oceanic monsters. We have a large backlog of creature-type material awaiting publication, so we ask that new monster submissions not be sent to us for at least four or five months.

**Credit is due:** After reading the description of the witch NPC in DRAGON® issue #114, Paul Suliin gave us a call. Long ago — in issue #18, in fact — we published an article by Paul describing new magic-user spells. Among them were some spells which were later adopted into the version of the witch published in issue #43, from which the revised witch was derived. TSR, Inc., owns the rights to all of these articles, but certainly Paul deserves the credit for such horrors as *mass polymorph*, *mystic rope*, *nature call*, *call spirit*, and my personal favorite, *rusting touch* (originally called *rust monster touch*). Thanks, Paul.

**Speaking of witches:** One reader wrote to ask why the witches of issue #114 were said to gain up to 13 spells at 22nd level (page 10), but were given only five spells at 22nd level on the witches experience table (page 12). The reference on page 10 is to the total number of High Secret Order spells that a witch may learn, but the table on page 12 shows how many that a witch may cast *per day*.

**Dropped copy:** A line disappeared between pages 27 and 28 in issue #115. The sentence crossing those pages should read: *These penalties are added to any adjustments for surface-types, and when both these factors are combined with the character's base climbing percentage, the character's true chance of scaling a given surface is revealed.*

As they say in *Amadeus*: There it is.



# The World Gamers Guide

If you live outside the continental United States and Canada, you can be included in the World Gamers Guide by sending your name and full address, plus your gaming preferences, to World Gamers Guide, DRAGON® Magazine, P.O. Box 110, Lake Geneva WI 53147.

Abbreviations in parentheses after a name indicate games in which that person is especially interested: AD = AD&D® game; DD = D&D® game; CC = CALL OF CTHULHU® game; GW = GAMMA WORLD® game;

SF = STAR FRONTIERS® game; ST = STAR TREK®: The Role-Playing Game; MSH = MARVEL SUPER HEROES™ game; TS = TOP SECRET® game; T = TRAVELLER® game; RQ = RUNE-QUEST® game; VV = VILLAINS & VIGILANTES™.

The World Gamers Guide is intended for the benefit of gamers who live outside the continental United States and Canada, in areas where nearby gamers are small in number or non-existent, as a way for them to contact

other game-players who would be interested in corresponding about the activities that they enjoy. Unfortunately, we cannot extend this service to persons who live in remote areas of the U.S. or Canada, or to U.S. military personnel with APO or FPO addresses. Each eligible name and address that we receive will be published in three consecutive issues of DRAGON® Magazine; to be listed for more than three issues, you must send in another postcard or letter.

Darren Marsland (DD,T)  
P.O. Box 14173  
Green Point  
8051 Cape Town  
Republic of South Africa

Edwin Berkhout (AD,DD,GW)  
Adm. Tromp st 20  
3333 TH Zwyyndrecht  
South Holland  
Netherlands

Jeff Johnson  
SPDC Ext. Nord  
B.P. 31  
Maroua  
L'Extreme-Nord  
Cameroun

Wayne George (AD)  
17 Colonial St.  
Campbelltown  
2560 N.S.W.  
Australia

Matthew Strickler (AD,DD,TS)  
Impasse de Mon Idee 3  
1226 Thonex  
Switzerland

Rafael Oliveira (DD,AD,TS)  
Rua Duque Estrada 46/1001 Ga'veja  
Rio de Janeiro - RJ  
CEP 22451 Brazil

David Baker (AD,DD)  
55-457 Moana St.  
Laie HI 96762

Talin Orodruin (DD)  
Manttoalitie 14 J 80  
90650 Oulu 65  
Finland

Bianca Jung (DD,AD,SF)  
Neuer Kamp 13  
3101 Nienhagen  
West Germany

Marcello Missiroli (AD,SO)  
Via Andreoli 12  
41100 Modena  
Italy

William Megill (AD,TS,SF)  
2 Frederick Close  
Stanhope Place  
London W2 24D  
England

Agarwaen Amon (DD)  
Manttoalitie 13 A 6  
90650 Oulu 65  
Finland

Martin Winstrand  
Perstorsv. 1  
S-310 70 Torup  
Sweden

Dan Mayshar (DD,AD,SF)  
31 Even Sh'muel  
Ramat 02  
Jerusalem, Israel

Avi Ifergan (AD,DD,GW)  
1 Plowman St.  
North Bondi  
Sydney  
Australia

The Gamers Guild (AD,T)  
Unit 2/1 Fitzgerald St.  
Northbridge, 6000  
WA Australia

David Johnston (AD)  
Chiba-Ken  
Ichikawa-Shi  
Yawata 6-31-4  
Satsuki-So 2F #5  
T 272 Japan

Daniel Folatelli (DD,AD)  
Casilla de Correo 181  
6600 Mercedes  
Provincia Buenos Aires  
Argentina

Alberto Halphen (AD,TS,SF)  
Lomas de Chapultepec  
M. Chimborazo 520/701  
Mexico DF C/P 11000

Eugene Yeung (AD,SF)  
6, St. Stephen's Lane  
4th Floor  
Hong Kong

Jason Cashill (DD,AD,RQ)  
P.O. Box 10962  
c/o ARAMCO  
Dhahran, Saudi Arabia

Luigi Sbaffi (AD)  
Via E. Bocci, 16  
60044 Fabriano (AN)  
Italy

Marney McDiarmid  
Ovre Bastad vei 26  
1370 Oslo  
Norway

Chris Darland (AD,T)  
c/o the Sesinas  
Jordanovac 115  
Zagreb, Yugoslavia 41000

DRAGON® Magazine (ISSN 0279-6848) is published monthly by TSR, Inc. The mailing address for all material except subscription orders is DRAGON Magazine, P.O. Box 110, Lake Geneva WI 53147; the business telephone number is (414) 248-3625. DRAGON Magazine is available at hobby stores and bookstores throughout the United States and Canada, and through a limited number of overseas outlets. Subscription rates via second-class mail are as follows: \$30 in U.S. funds for 1 year (12 issues) sent to an address in the U.S. or Canada, \$55 for 12 issues sent by surface mail to any other address, and \$95 for 12 issues sent airmail to any other address. Payment in full must accompany all subscription orders. Methods of payment include checks or money orders made payable to TSR, Inc., or charges to valid Mastercard or VISA credit cards. Send subscription orders with payments to: TSR, Inc. P.O. Box 72089, Chicago IL 60690. A limited quantity of back issues are available from the TSR mail order department, P.O. Box 756, Lake Geneva WI 53147. For a copy of the current catalog listing available back issues, write to the mail order department at the above address. The issue of expiration of each subscription is printed on the mailing label for each subscriber's copy of the magazine. Changes of address for the delivery of subscription copies must be received at least six weeks prior to the effective date of the change in order to assure uninterrupted delivery. All material published in DRAGON Magazine becomes the exclusive property of the publisher, unless special arrangements to the contrary are made prior to publication. DRAGON Magazine welcomes unsolicited submissions of written material and artwork; however, no responsibility for such submissions can be assumed by the publisher in any event. Any submission accompanied by a self-addressed, stamped envelope of sufficient size will be returned if it cannot be published.

DRAGON is a registered trademark for the monthly adventure role-playing aid published by TSR, Inc. All rights to the contents of this publication are reserved, and nothing may be reproduced from it in whole or in part without first obtaining permission in writing from the publisher. Copyright ©1986 TSR, Inc. All Rights Reserved.

AD&D, ADVANCED DUNGEONS & DRAGONS, D&D, DRAGONLANCE, DUNGEONS & DRAGONS, FIEND FOLIO, GAMMA WORLD, TOP SECRET, STAR FRONTIERS, and TSR are registered trademarks owned by TSR, Inc. GEN CON is a service mark owned by TSR, Inc. ARES, BATTLESYSTEM, DEITIES & DEMIGODS, DUNGEON, and the TSR logo are trademarks owned by TSR, Inc. ©1986 TSR, Inc. All Rights Reserved. All Marvel characters and the distinctive likenesses thereof are trademarks of the Marvel Comics Group. MARVEL SUPER HEROES and the MARVEL UNIVERSE are trademarks of the Marvel Comics Group. Copyright ©1986 Marvel Comics Group, a division of Cadence Industries Corporation. All Rights Reserved.

CHEERS ® and © of Paramount Pictures Corp. STAR TREK is a trademark of Paramount Pictures Corp. ELFQUEST and the likenesses and characters contained therein are registered trademarks of WaRP Graphics Inc. ©1986 WaRP Graphics Inc. The ELFQUEST role-playing game is copyright ©1984 by Chaosium Inc. CALL OF CTHULHU is a registered trademark of Chaosium Inc. The DOCTOR WHO television series is Copyright ©1986 by the British Broadcasting Corporation; the DOCTOR WHO game design is Copyright ©1985 FASA Corporation. All Rights Reserved. TRAVELLER is a registered trademark of Game Designers' Workshop. The terms WICKERMAN INCENDIARIES, LTD., and WINTERHAWK ARMS, INC., are Copyright ©1983 by William A. Barton.

Second-class postage paid at Lake Geneva, WI, and additional mailing offices. Postmaster: Send address changes to TSR, Inc., P.O. Box 110, Lake Geneva WI 53147. USPS 318-790, ISSN 0279-6848.



# Michael Moorcock's HAWKMOON



Duke Dorian Hawkmoon

Please list game title and product number. Include \$21.95 plus \$2.00 for postage and handling. All payments must be made in U.S. funds. No COD. Prices subject to change without notice. Allow two to four weeks for delivery.

**CHAOSIUM INC.**

Box 6302, Albany CA 94706-0302



This game is based on Michael Moorcock's *History of the RuneStaff* and *Chronicles of Count Brass* novels.

## *The Eternal Champion*

The Eternal Champion is a mystical hero who lives on all planes of existence, in all ages and times. Whenever the greatest need arises, the Eternal Champion awakens to ensure mankind's survival. His names are many: Elric, Corum, Erckose, Urlik, Hawkmoon, and a multitude of others. Into the thick of the fray he strides, heroic companions at his side.

Dorian Hawkmoon, Duke of Koln, is an incarnation of the Eternal Champion and the sworn enemy of the foul Granbretan empire. His homeland was ravaged, his people were murdered, and the twisted scientists of Granbretan sought to enslave Duke Dorian's mind — thus the Jewel in the Skull.

**Hawkmoon™** is an easily-played game of fantasy roleplaying for 2 or more players, ages 12 and older. It is part of the **Eternal Champion** line of roleplaying games available from Chaosium Inc. The game players create imaginary characters who adventure together through a vision of Earth as it might be — long after the nuclear and chemical destruction of the Tragic Millenium — a world where magic is real and heroes exist.

This box contains everything you need to create and play such adventures.

**HAWKMOON ROLEPLAYING GAME [2106-X]**

**\$21.95**

HAWKMOON is completely compatible with its companion game STORMBRINGER. They comprise the ETERNAL CHAMPION line of games available from Chaosium Inc. Characters created for one ETERNAL CHAMPION game will function without flaw in any other game of the series. The strength of Law or Chaos on a plane may affect a character's magical ability (demons take note!).

# Science & Sorcery in Earth's Far Future



---

---

# FORUM

I have a friend in one of my classes at school who is female. She is also a Dungeon Master and she is very good at it. There is only one problem. I think every female DM wants to know how to get people to join her campaign. My friend asked people who were already playing the game and people who were interested in learning how to play. Every male she asked just laughed at her and said that she wasn't any good. She asked the guys why they felt that way, and they said they had never seen a female DM; if they did, there was no doubt in their minds that her campaign would be boring.

Well, she kept trying to get people, and one day she saw me bring the *Players Handbook* into class. That afternoon, she saw me at my locker and asked if I would join her campaign (this was before I became a DM myself); I said I would, and we set up some times to play.

I really expected more than one person to show up, but I was the only one there. I already had a character that I had had from a previous campaign; it was a 3rd-level elven fighter/magic-user (I really didn't think she'd let me use it). I played, still expecting someone else to arrive, but no one did. Before I left I asked her why I was the only one who was playing and she looked at me and simply replied, "because I'm a girl."

I don't know many female DMs, but I'm sure, they're out there, and I think that everyone ought to use a little more consideration before saying "no." They don't know what she's like and don't know how good she is at DMing. I don't really think it's fair to judge someone's abilities by their sex, color, or religion.

Craig Sessions  
Hiialeah, FL

Now that we are abandoning realism, I feel compelled to speak up on a subject I've felt strongly about for a long time — that is the poison rule. This rule may be realistic, but it's the biggest *bummer* this game has! Who wants to defeat the Archmage of Telfrost just to come out and be killed by a lousy 2-hp snake? I don't!

This is what I propose: poison on objects should be the same as before (see *DMG*; p. 20), but poison on or from a creature should do damage equal to that creature's hit points. This rule is not totally unrealistic, since it allows more powerful creatures to be more deadly than tiny ones. If you feel that a creature's poison should be more deadly, even though that creature is small or not powerful, simply assign a penalty to the saving throw.

This rule also works for the reverse *neutralize poison* spell, causing this spell to be increasingly potent at higher levels while being slightly weak at lower levels.

Soon, your PCs will be laughing at puny water spiders, but putting on their running shoes at the first sight of a spirit naga.

Dan Thompson  
Hillsdale, NY

I'd like to address a topic that, to the best of my knowledge, I've not seen discussed either by you or the readers. There seems to be a disproportionate number of older people and women playing AD&D® games. These two groups comprise a sizable potential game-playing public. It has been shown statistically that the majority of men and women, from teenagers on up, play some form of "living room" or table game. Why not the DUNGEONS & DRAGONS® game? Trivial Pursuit, bridge, and Monopoly need not win out over the AD&D game — a much, more creative and challenging game. A poker player would find the "gamble" element just as exciting as "down in a dungeon."

Perhaps we as players, as well as the makers and sellers of the game, have unconsciously overlooked or ignored these groups, deciding the game is not for them. Let me assure you: older men and women add immensely to the game and enjoy it just as much. They add color and experience to the drama of game play.

I am forty years old and have been playing for five years in groups with older players. Gaming dimensions are expanded by the real-life logic and reasoning the older person brings to the game for both the overall game plan or quest.

Why doesn't TSR advertise the game in *Vogue*, *Woman's World*, or *Cosmopolitan* magazines, for example? How about *Wall Street Journal*, *Esquire*, or even *Good Old Days*? Women's radio and television talk shows and women's organizations could also be channels. Seminars given through city government park districts and city sponsored teen and senior citizen clubs are another possibility. (Readers, we could be doing something about this in our own towns.) Seminars at GEN CON dealing with the "Women and D&D® gaming" and "The Older Veteran Gamer" topics could crystallize our attention and action on this issue.

When players are recruiting their friends to play D&D games, how about including their parents? I have had my sons play AD&D games, and I'm trying to get their grandparents interested as well.

I think the point has to be made that as the ADVANCED DUNGEONS AND DRAGONS® game system is expanded and improved upon, the game-player world can also be expanded (yes, improved too) with a widening age span and with greater participation of women.

It's up to us to get them into our game. We will all benefit.

Alan D. Long  
Aurora, IL

In the article "For sail: one new NPC" (*DRAGON*® Magazine #107), the mariner class NPC was introduced. After playtesting mariners several times, I have found that this excellent class of NPC's is a good and needed addition to the AD&D® game system. However, I have found that some new abilities could be added to this NPC class to deepen and develop it. These new abilities are as follows.

## New mariner abilities

1. When a boat is sailed totally by mariners, it may travel 1.2 times as fast as normal on long journeys and may increase speed up to 1.5 times normal for short runs of less than one mile one time per day, providing that sufficient winds are available. This ability is gained because mariners do not always have to be supervised by an experienced sailor while sailing because they know how to do most of their duty with little commanding or observation. They also know how to operate a vessel more effectively because of "tricks of the trade" gained through sea experience.

2. A mariner may tie all types of knots quickly and efficiently. These knots are always secure and never become accidentally undone. A mariner may also bind hostages so that they must make their *bend bars* roll at -5% to escape. Mariners gain a +5% chance on their *bend bars* roll to escape from rope bonds because of their familiarity with knots. Typical knots that mariners may tie are the bowline, square knot, half hitch, double-half hitch, cleat knot, and the sheet bend. Mariners are also familiar with the process of making wire to rope and rope to rope splices. They fully know how to use all splicing tools such as the marlin spike, the ditty bag, and the bending rod.

3. Since the mariner travels to many lands and experiences many new ideas and customs, he soon becomes readily adaptable to any mode of life. Mariners who were shipwrecked in medieval and classical times often had to adapt to new styles of life and make friends with the inhabitants of the islands that they were shipwrecked on in order to find a way to escape and return to their home countries. This can lead to some interesting AD&D games for characters stranded in oriental lands such as Kara-Tur from *Oriental Adventures* or in savage lands such as the southern jungle islands of Greyhawk.

4. Feuding mariners who do not wish to destroy their expensive ships in a sea battle may challenge each other to a sea race. This sea race will be at least 10 miles in length and may be run through a treacherous course.

A good way to determine the outcome of such a race is to add both ships base speed in miles per hour (see the *Dungeon Masters Guide*, page 54) to the average level of sailor on the ships. The winner of such a race will be the captain with the highest overall rating on his ship. Do not forget to roll for random encounters during this race. If such a race is run through an especially treacherous course, use the piloting ability of mariners to see if the ship is damaged. Mariners usually will not cheat in a race such as this because of their respect for the sea. Sea deities strongly discourage cheating in this manner. The loser of a sea race will agree to whatever reasonable demands the winner makes as long as it stops the feud. The demands given by the winner of a sea race are often specified before the race in a written contract.

Niel Brandt  
Janesville, WI

I have a question that I would like to present to the Forum. I am curious as to how other players and DMs feel about the bits of humor that are interjected into various TSR materials. For example, when I read through the AD&D® game adventure in *DRAGON*® Magazine #84 ("The Heart of Light"), I thought it was righteously humorous; however, when I ran the module, the players' primary reaction was one

(Continued on page 36)



# A GREAT GENERAL CAN WIN ANY WAR.

Gamemaster challenges you to prove it with the greatest battles ever fought from the past to the future! Stalk the battlefields of the Ancient World in Conquest of the Empire. Dominate the global theatre of

World War II in Axis and Allies.

And now launch yourself into the 21st Century with new Fortress America.

The Scenario: For the first time in history the United States is being invaded.

Deploy bombs, laser complexes and hover tanks to attack or defend U.S. cities and resources.

The Gamemaster Series—

The games you'll play as if your life depended on it.

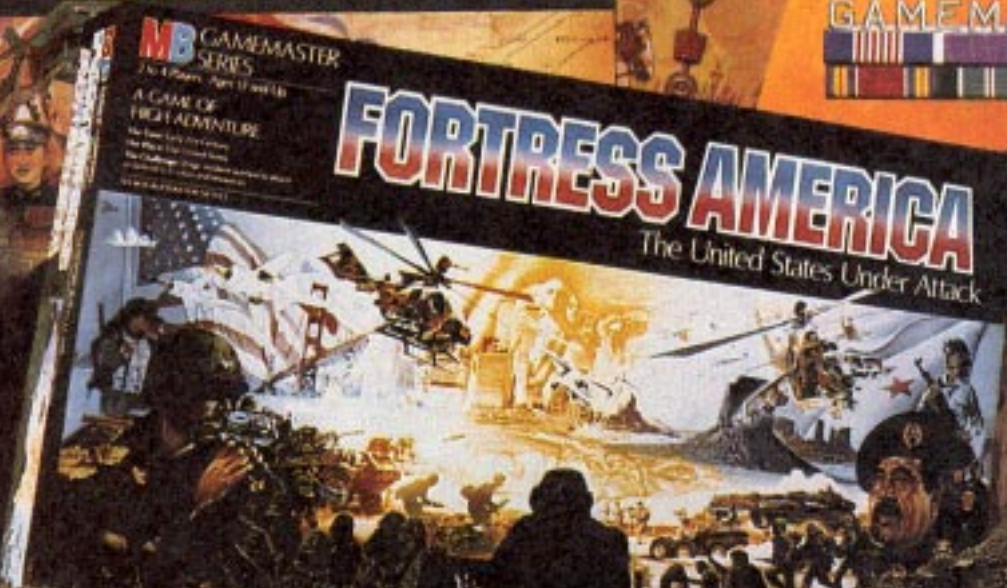

© 1986 MILTON BRADLEY COMPANY  
THE GEMMASTER SERIES IS A REGISTERED TRADEMARK  
OF THE MILTON BRADLEY COMPANY, A SUBSIDIARY OF  
HASBRO, INC.



Discover the true power of the elements and you will find nature as deadly a foe as any monster.

Companion volume to the Dungeoneer's Survival Guide, the new AD&D® Wilderness Survival Guide is the complete reference work for the realms beneath the sun.

With new and expanded rules covering terrain, weather and a guide to campaign mapping, the Wilderness Survival Guide adds a whole new dimension to the wilderness adventure.



TSR, Inc.

PRODUCTS OF YOUR IMAGINATION™

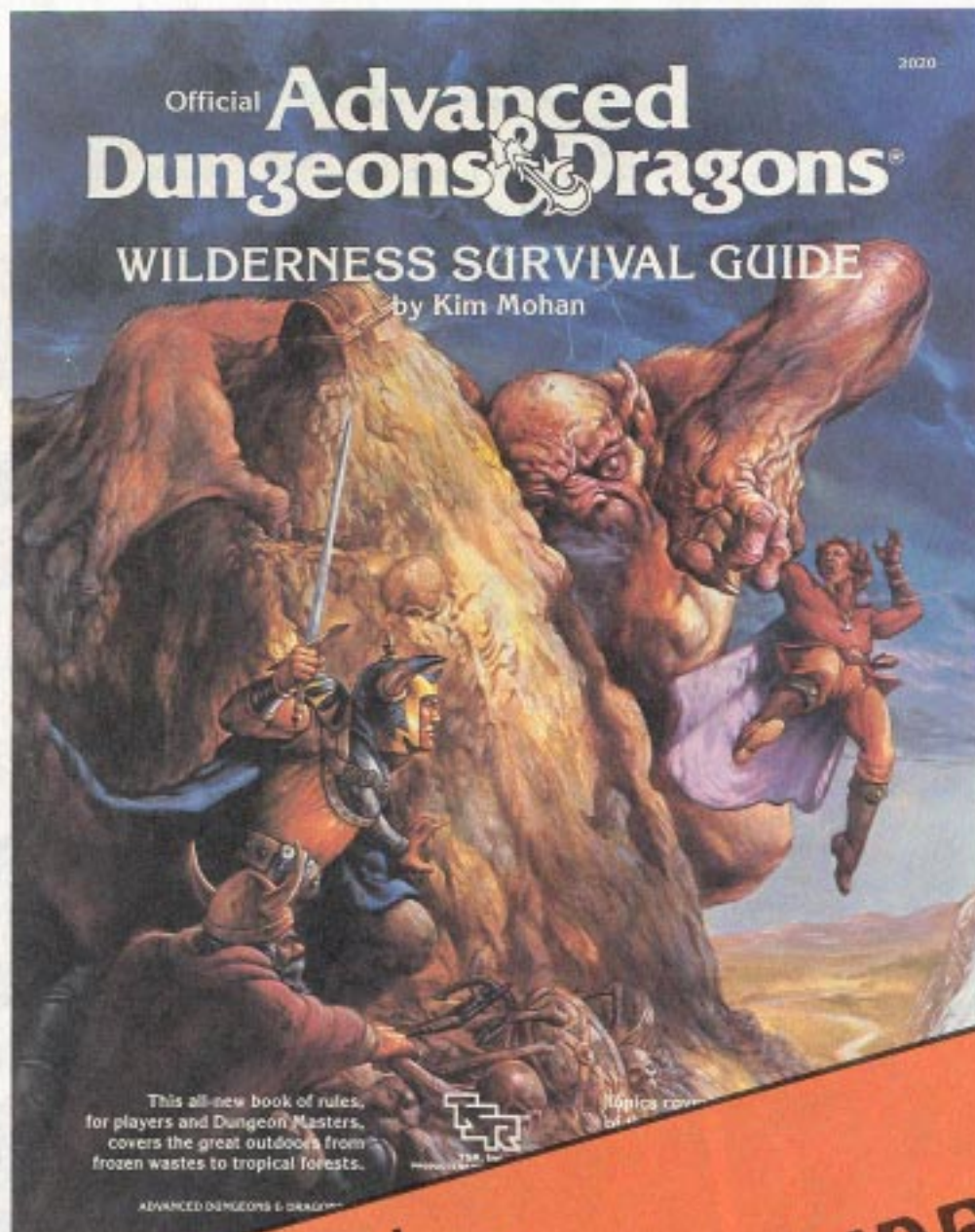

This all-new book of rules, for players and Dungeon Masters, covers the great outdoors from frozen wastes to tropical forests.

ADVANCED DUNGEONS & DRAGONS™

# Advanced Dungeons & Dragons WILDERNESS SURVIVAL GUIDE

TSR Inc.  
POB 756  
Lake Geneva  
WI 53147

TSR UK Limited  
The Mill  
Rathmore Road  
CAMBRIDGE  
CB1 4AD



# MARITIME ADVENTURES

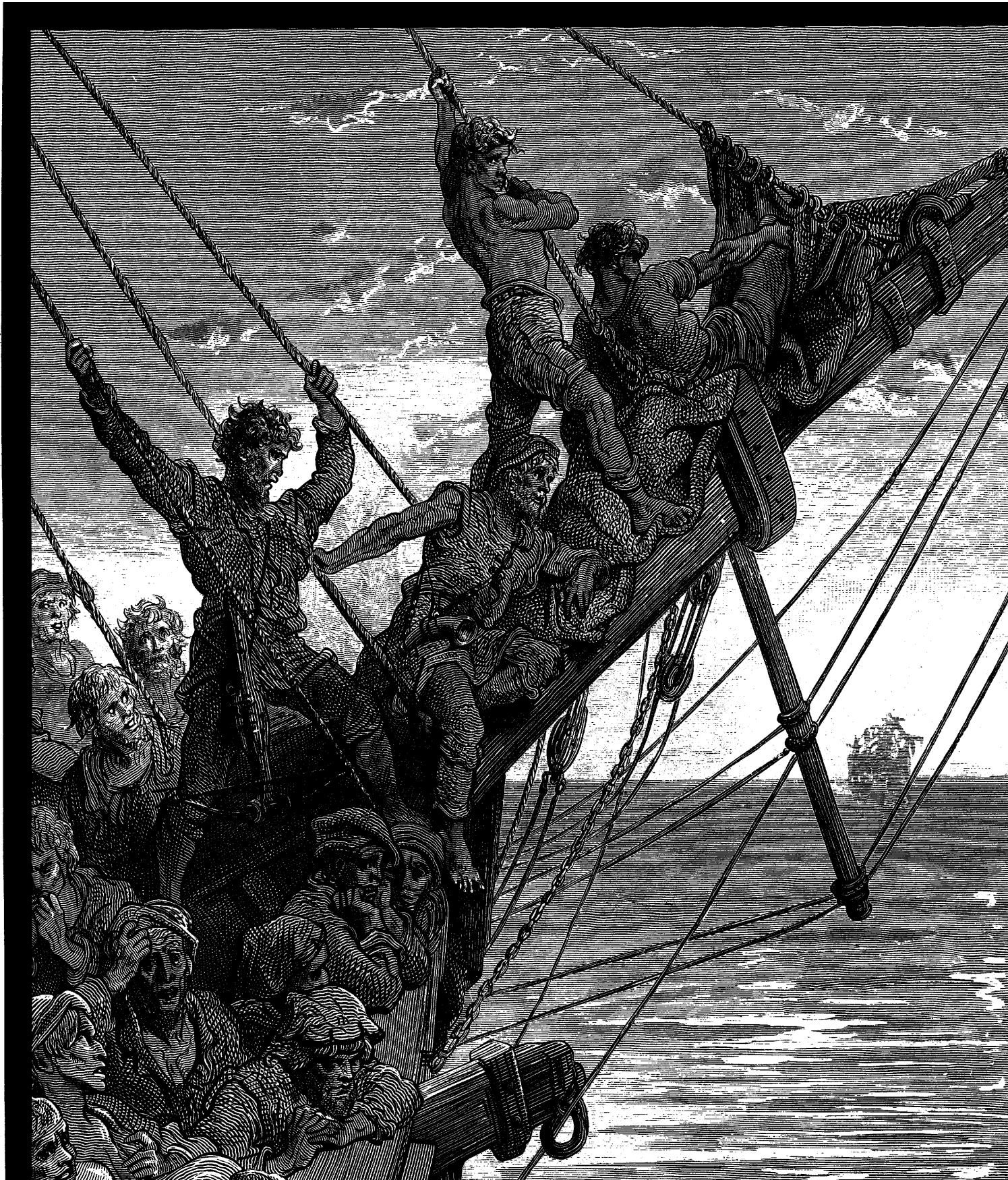

# High Seas

By far, ships have excited the imagination more than any other form of transportation. Odysseus, Horatio Hornblower, Sir Francis Drake, Captains Ahab, Nemo, Blood, and Bligh; the *Beagle*, the *Argo*, and the *Flying Dutchman* — the list of names goes on and on. Ships battle wind and wave, sea monsters, fate, and each other, and those aboard run the gamut from shining hero to basest knave. Ships have a way of stimulating the imagination, generating interest in the high seas and nautical adventure. This affection is no stronger than in the gaming hobby, where sailing miniatures and board games garner attention and reflect this preoccupation with the Age of Sail. Role-players who are thus afflicted may take heart. Now, one can satisfy two cravings at once: the desire for adventure on the high seas and playing the AD&D® game.

Much of this article is based upon information relevant to the Age of Sail up to the 19th century. However, there is no reason why an advanced nation of a fantastic world could not produce ships much like the "big sail" craft popular during that era. Sailing ships should evolve in magical worlds as they have in our technological one.

## Nautical terms and definitions

Some nautical terms need to be introduced. For purposes of this article, a galley is any vessel that is rowed and sailed. A ship is a sailing vessel, pure and simple. The rear half of a vessel is the aft, and the front half is the fore. The fore part is the bow, and the aft part is the stern. If one is facing the fore, the left side is port or larboard, whereas the right is starboard.

In order from fore to aft, the masts on a sailing ship are called the fore, main, and mizzen masts; on a two-master, they are the main and mizzen masts; and, on a four-master, they are the fore, main, third, and mizzen masts. A square rig has square or rectangular sails hanging from the crosspieces on the masts (the crosspieces are called yards or yardarms). On a fore-and-aft rig, the sails are shaped like a right triangle. One apex of the triangle is attached to the mast and another to a traverse beam from the lower mast called a boom. A lateen rig uses very large sails shaped like a right triangle. The hypotenuse side of a lateen rig's sail hangs from a very wide yard, and the sail is loose-footed — that is, without a boom at the bottom. A square rig gives a vessel quite a bit of power, but requires many sailors to operate. The fore-and-aft rig requires fewer sailors and is more maneuverable, but delivers less power to the ship. The lateen rig is midway between the two, both in terms of power and number of sailors required to handle it. The masts are braced by sets of heavy cables called the standing rigging, while the ropes used to manipulate the sails, yards, and booms are called the running rigging.

The lowest space inside the ship is the



*Ships, fore and aft,  
in fantasy gaming*

---

by Margaret Foy

---



hold, where the cargo and supplies are stored. Above the hold is the orlop deck, where there are more supplies, the hearth, and the crew's mess tables; it is also where the wounded are put during battle. Above the orlop deck are the lower, middle, and upper decks. The crew sling their hammocks on the lower and middle decks, and on the orlop deck when the ship is very crowded. Light, medium, and heavy mangonels (small catapults used at sea in the 11th and 12th centuries) are emplaced on the upper, middle, and lower decks, respectively. Not all vessels have a full number of decks; very few do.

Aft of the mizzen mast, over the upper deck, is the quarterdeck, which roofs over the space where the officers and some petty officers have their quarters. Fore of the foremast, over the upper deck, is the forecabin, where the rest of the petty officers sleep and mess. Between the two partial decks, the open area of the upper deck is called the waist, in which the ship's boats are stored. Over the quarterdeck is the smaller poop, and over that is the even smaller poop royal.

The medieval ships (cog, carrack, caravel, galleon) were built high-charged, meaning that wooden towers were added to the hull after the ship was finished, making them top-heavy. Later, these wooden "castles" were built as part of the hull, but the ships had only one or two full decks. High-charged ships were top heavy and liable to capsizes. Low-charged ships added full decks, limited the number of partial decks, and had a deeper draft (the distance from the waterline to the keel); thus, their center of gravity was lower.

### Ship personnel

At the bottom of a vessel's hierarchy is the landsman (landswoman, -elf, or what have you). This landlubber has no nautical experience at all and requires four to six months of training to become an ordinary sailor. An "ordinary" has no special skills, but can go aloft in the rigging to handle the sails, and on a galley he can be trusted to follow most commands. After a year of training, about half of the ordinaries become able-bodied sailors (ABs). ABs can make repairs and splice ropes, and know all the knots; in short, they now "know the ropes." On a galley, they are also the lead rowers, whose actions give the cues to the ordinary sailors. Mates, or assistants to petty officers, are ABs who have special skills. On a galley, the mates are spaced out among the banks of oarsmen, since they set the tempo for the other rowers.

The petty officers and their mates are as follows: The bosun (or boatswain) and the bosun's mates are in charge of various odd supplies and the ship's daily maintenance. The master-at-arms has charge of the ship's weapons locker, training the crew in combat and administering discipline. The sailing master navigates the ship and teaches navigation to the master's mates and the middies. A quartermaster is a very

junior master's mate who takes the wheel and steers the ship. Midshipmen (middies) are petty officers in training to become lieutenants. Middies supervise work parties of sailors and do anything else a lieutenant tells them.

The previously mentioned petty officers are in the chain of command (COC), which indicates who is to take command of a ship when the captain is killed or incapacitated. The proper order of the COC, descending in rank after the captain, is: lieutenants, middies, the sailing master, master's mates, quartermasters, the bosun, and finally, the master-at-arms. If the master-at-arms dies or is incapacitated, the COC is exhausted and the command is up for grabs (and so is the vessel, usually).

There are other petty officers and mates not in the COC: the cooper, sailmaker, cook, carpenter, purser, and their mates. All petty officers report to the first lieutenant except for the sailing master, who reports directly to the captain. On small vessels, the petty officers report to the sailing master or, if there is none, directly to the captain. Petty officers are sometimes called warrant officers.

The lowest-ranking commissioned officer is the lieutenant, the most senior of whom oversees the daily operations of the vessel. Lieutenants frequently command cogs, cutters, or brigs. In rank above a lieutenant is the commander, usually commanding a caravel, brig, or corvette. Next highest is a captain who, for the most part, commands a carrack, a frigate, or a ship-of-the-line. A commodore is the captain of his own ship and commands a squadron of two to eight vessels. The various types of admirals command larger squadrons or fleets, but never a vessel. Even an admiral's flagship is commanded by its own captain.

Regardless of actual rank, the person commanding a vessel is called Captain. When introductions are used in conversation, use the following form: Lt. Alex, commanding the cutter Valiant. Any officer of the rank of captain who is not in

command of the vessel is referred to by the title of the rank one step higher than captain. This courtesy promotion is used to avoid having more than one person addressed as Captain aboard a vessel.

Marines have their own officers and command structure. Their highest officer reports to the captain of the vessel. Their use on vessels is twofold. Firstly, they provide small missile fire from the decks or fighting tops (the small platforms at the top of the masts). Secondly, they fight boarding battles. The crew and petty officers of the vessel load and fire the artillery engines.

Large vessels also carry a third group of auxiliary officers. These are specialists or spellcasters, and their chief officer reports to the captain. An officer may also be a spellcaster.

The system herein can be used with all the official character classes outlined in the *Player's Handbook* and *Unearthed Arcana*. The ship's complement as given in this article is not an attempt to introduce a new character class. Middies, quartermasters, and all the rest are the titles of positions. If a DM wishes to use the mariner NPC from DRAGON® Magazine issue #107 ("For Sail: One New NPC," by Scott Bennie) with this article, he should have no problem. Use the appropriate level of mariner for each position on the ship, complete with their special abilities, but ignore the various effects of crew ability. Vessels' statistics as given in the mariner NPC article are not compatible with this article. If you decide against the use of the mariner NPC for an entire vessel's complement, it is still recommended that the mariner be used for officers – especially the sailing master, master's mates, and the quartermasters.

A typical ship's personnel may be assigned levels as follows: landsman 0, sailor 1, mate 2, petty officer 3, sailing master and lieutenant 4, commander 5, captain 6, commodore 7, admiral 8 and higher. Aboard rowed vessels, the oarsmen are either zero or 1st level.

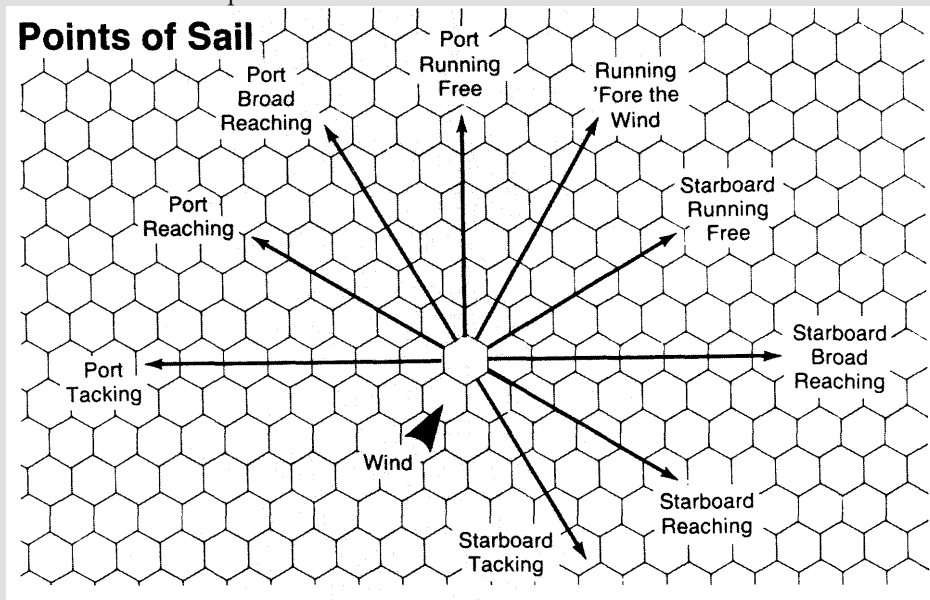



The sun now rose upon the right:  
Out of the sea came he,  
Still hid in mist, and on the left  
Went down into the sea.

And the good south wind still blew behind,  
But no sweet bird did follow,  
Nor any day for food or play  
Came to the mariners' hollo!

From "The Rime of the Ancient Mariner"  
by Samuel Taylor Coleridge.

Illustration by Gustave Doré,  
courtesy of Dover Publications, Inc.

### Ship types and functions

The earliest European ships built solely or war were galleys with prows lengthened to form a ram. The galley that offered the best combination of speed, maneuverability, and offensive ability was the trireme. Its career lasted from the fifth century B.C. to the fourth century A.D. The trireme had three banks of oars with one rower per oar. These galleys were undecked (aphract). By 300 B.C., triremes were often cataphract — that is, decked. A later galley with a long career was the quadrireme.

The hemiolia was a galley used exclusively by pirates. The lower bank had 12 oars and the upper 13 (one rower per oar). The triemiolia, banked and oared as a trireme, was developed to chase pirates. Both could be rowed and sailed at the same time. The hemiolia's aft six pairs and the triemiolia's aft 15 pairs of upper oars could be quickly shipped and the benches cleared away. The rowers were then free to lower and store the sail, unstep the mast, and arm for a boarding battle. Both

ships were aphract.

Ancient galleys suffered from three major disadvantages. Their low freeboard and light construction made them unlikely to survive a storm in the open sea. They lacked cargo space; they had little room to carry water or food, let alone space in

which to cook, and they had little room in which to sleep. Fortunately, their construction allowed them to be beached easily. Another bright spot was that they could be portaged easily. An ancient galley could be portaged on rollers by its crew 2 1/3 miles a day. But the greatest disadvan-

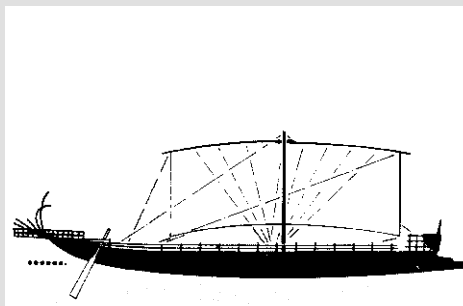

**Galley**  
(5th Century B.C.)

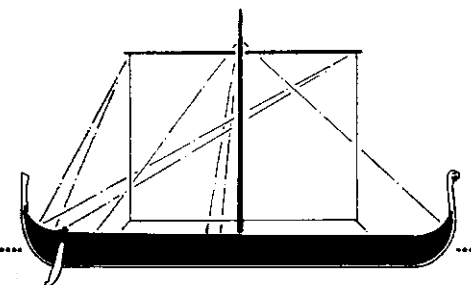

**Longship**  
(10th Century)



tage of the fighting galleys was the crew. Galley crews had to be highly trained to work together. The crews were large, and they had to have a high morale. For the galleys that relied on ramming to win their battles, the crews had to be of very high quality. But the galleys that relied on marines to win boarding battles could operate with average or poor crews. The ancient navies never used slave rowers; despite Hollywood history, that practice didn't arise until the fifteenth century A.D. In desperate circumstances, even slaves would be freed if they volunteered.

Aphract galleys used the ramming strategy. At the beginning of a battle, the galleys would work up to battle speed and attempt to ram an opponent straight amidships. If successful, the rammer would immediately row backwards to disengage its ram; otherwise, the ram could be lost. The crew and marines on the rammed ship attempt to grapple the rammer to board and take it. Even if a ship missed in its attempt to ram, it might succeed in running along the side of its opponent and breaking off its oars. This required the raking galley ship to take in its oars before the attempt to rake.

Cataphract galleys grappled their opponents; then the marines fought a boarding battle. A naval engagement often developed into a large raft of boarding battles. Two devices were introduced to assist in boarding. The corvus was a bridge 36' long and 4' wide carried upright in the bow on a swivel mount. The far end had several spikes on the bottom. When an enemy galley was close enough, the lines holding it up were cut, allowing it to fall and spike itself to the enemy galley. The harpax was an iron-bound ballista missile with several lines attached to a winch at one end and a grappling iron at the other. The idea was to grapple and winch in an enemy. Pots of flaming oil were carried at the end of long poles that extended from the bow and sides of the galleys.

The drakkar or Viking longship was a very different sort of vessel. Unlike the ancient galleys that were built like racing shells, it had a true keel and was clinker built (like shingles), giving it strength and

## Ship Diagram

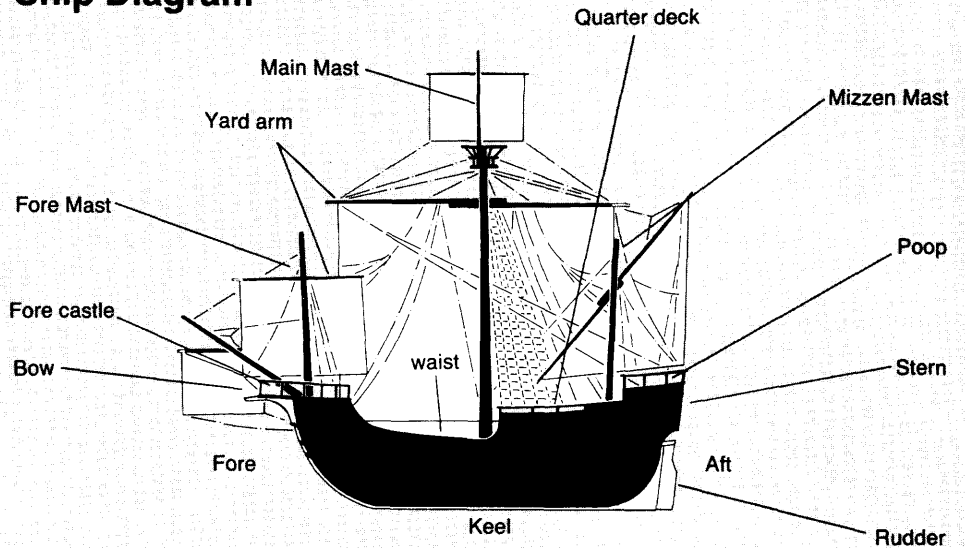

flexibility. The oars were used to row up rivers and maneuver in tight passages. Since they had no rams, drakkars fought each other by boarding battles. River galleys were used not only on rivers and lakes, but also in sea ports for patrol.

The cog was a European ship of the 13th and 14th centuries. The rear castle was square, and the forecastle was triangular. Both were raised platforms added to the structure of the hull. The cog continued its career in the Mediterranean in a late-rigged form for another century.

The caravel was a ship of the 15th to 16th centuries. It averaged 70-100' in length and was surprisingly seaworthy and fast. Its low draft made it excellent for trade without the benefit of ports (and for smuggling). Both the *Nina* and the *Pinta* were caravels.

The carrack was the first European ship to carry artillery and guns. Before then, naval battles were land battles fought on planks. The carrack's career lasted from the 15th to mid-16th centuries. The cog, caravel, and carrack were all general-purpose ships, used as warships, merchantmen, and pirates.

The galleon was a warship of the 16th through 17th centuries. Later, it was four-

masted and carried up to a hundred guns. It was the final development of the high-charged ship. The galleon was slow, not very maneuverable, and prone to capsize (as were all high-charged ships).

Cutters and brigs were customarily used in coastal duties to fill out a blockade and carry mail, dispatches, or official passengers. The corvette, or sloop-of-war, was the fastest ship of the time, but it was not as well armed as the frigate. Corvettes could be used as convoy escorts, as squadron ships, and as pursuit ships in blockades and against smugglers.

One third to half of the navies of the 17th and 18th centuries was composed of frigates. The frigate was the workhorse of the navy. It was well armed, maneuverable, and not as slow as ships-of-the-line. In fleet battles, frigates sailed to one side to repeat the admiral's orders and tow away heavily damaged ships. Frigates were also used as fleet scouts, convoy escorts, blockade and squadron leaders, and spies against enemy ports.

The largest fighting vessels of the mid-17th to mid-19th centuries were the ships-of-the-line, rated first to fourth. First rates generally stayed in home waters to protect important sea ports and coastal facili-

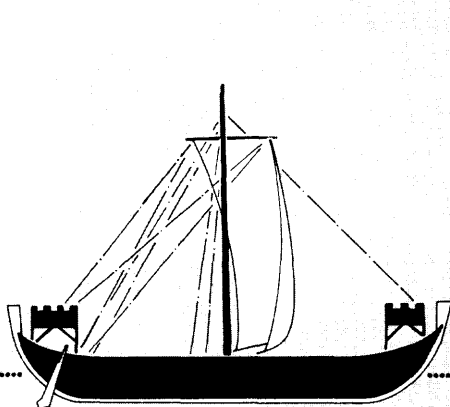

**Warship**  
(13th Century)

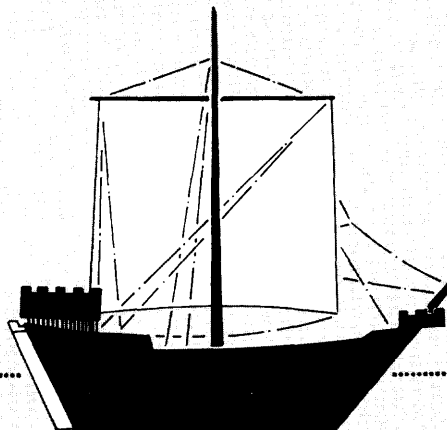

**Cog**  
(13th Century)

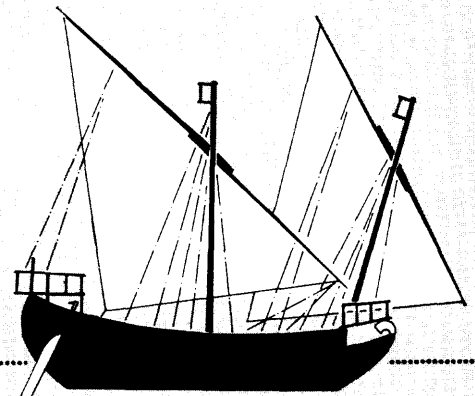

**Merchantman**  
(13th Century)

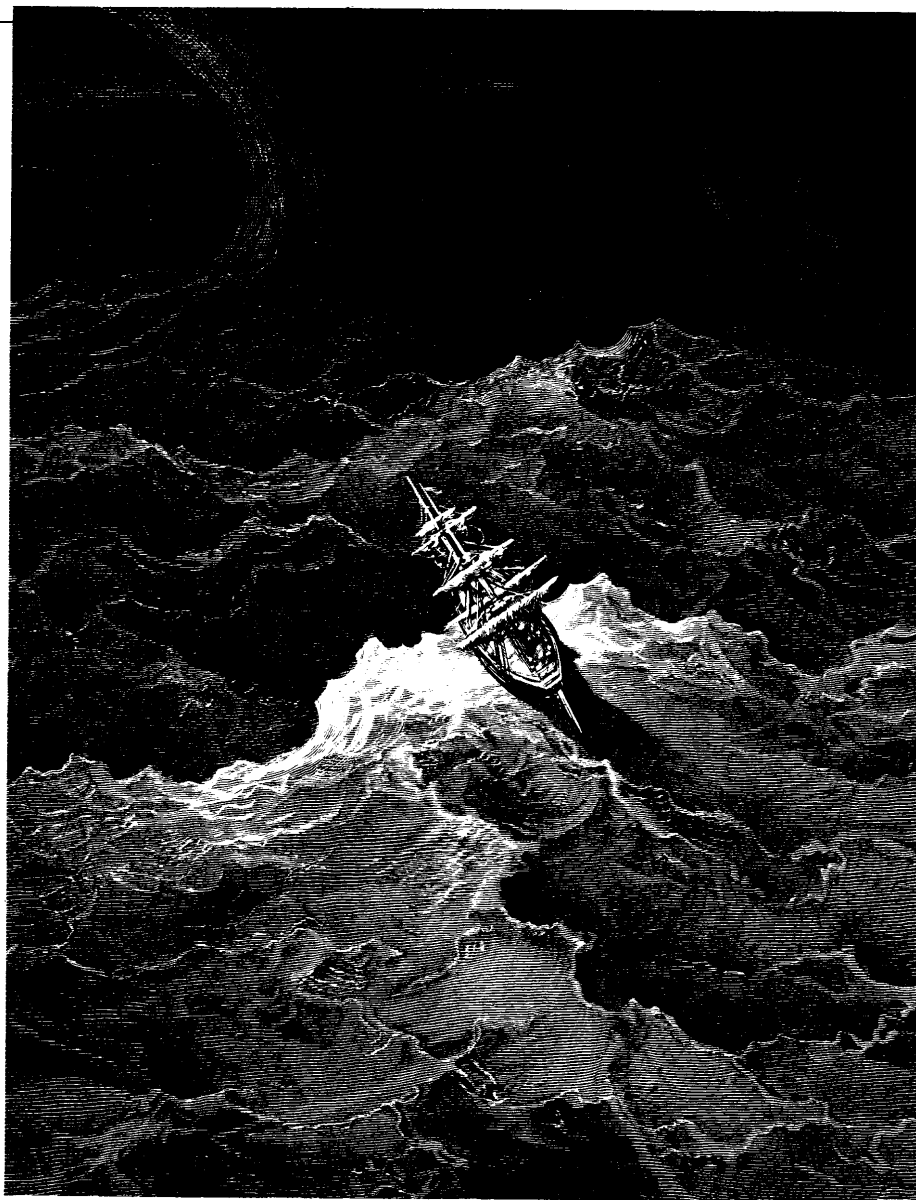

AND NOW THE STORM BLAST CAME, AND HE  
WAS TYRANNOUS AND STRONG:  
HE STRUCK WITH HIS O'ERTAKING WINGS,  
AND CHASED US SOUTH ALONG.

With sloping masts and dipping prow,  
As who pursued with yell and blow  
Still treads the shadow of his foe,  
AND FORWARD BENDS HIS HEAD,  
The ship drove fast, loud roared the blast,  
AND SOUTHWARD AYE WE FLED.

From "The Rime of the Ancient Mariner"  
by Samuel Taylor Coleridge

Illustration by Gustave Doré.  
courtesy of Dover Publications, Inc.

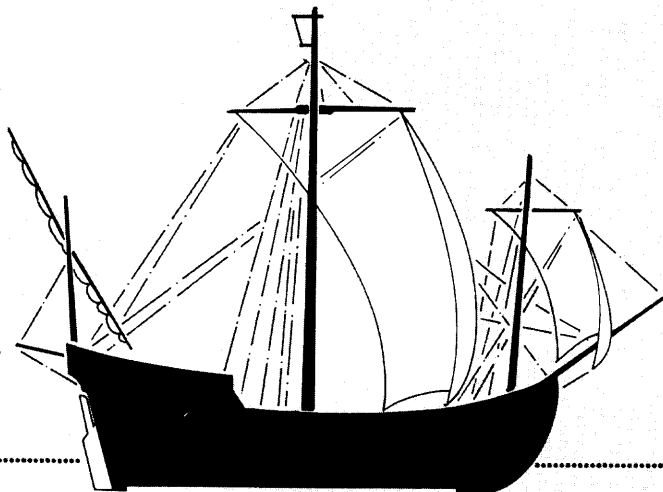

**Caravel**  
(14th Century)

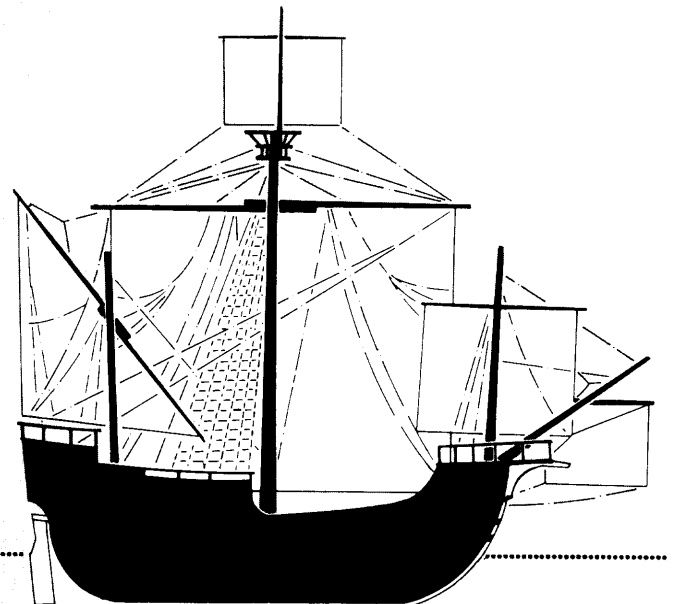

**Carrack**  
(15th Century)



ties. Second rates were usually admirals' flagships. Third and fourth rates were often assigned to senior captains. These ships made up the bulk of a fleet, but not the majority of a navy. They cost a lot.

Naval transports and their commercial counterparts were slow, unwieldy, and nearly defenseless. As such, they were always escorted. Navies used them to carry troops, horses, supplies, weapons, and ammunition. Commercial transports carried bulky and heavy cargoes: grain, cattle, stone, ore, metal ingots, etc.

Cutters, sloops, and schooners were used mostly for fishing, trade, and carrying passengers. The fastest commercial ship was the clipper, which carried passengers and cargo that required great speed. Passage on a clipper often ran high (500 gp would be reasonable in AD&D game terms), and cargo rated up to 25% of the assessed value for bulky loads. The second fastest were the packets, which usually carried passengers or mail. In times of war, many navies commissioned packets to carry military mail and dispatches. The small, medium, and large cargo ships were generic merchant ships of the 16th to mid-19th centuries.

The difference between the roles of warship and merchantman are clear, but the difference between a pirate, buccaneer, and privateer can be very blurry. For our purposes here, a pirate is one who unlawfully molests, threatens, fires upon, detains, or harms a vessel or those on it. A buccaneer is a pirate who does not harass the ships of one particular nation — generally the nation whose ports the buccaneers are using. Obviously, one country's buccaneer is another's pirate. A privateer is a ship that has been awarded a letter of marque by a government. The letter specifies which ships are fair game and for what reasons. Governments issue letters of marque to harass an enemy's shipping in war time and in peacetime to suppress piracy and smuggling.

Once a privateer has captured a prize, it must bring or send the captured ship to a port in the country issuing the letter. There, a Prize Court determines if the prize was covered by the letter; if it was, the ship and its cargo are then auctioned. The government has the right to buy the ship for itself before auction. The privateer keeps 75% of the price and the rest goes to the government. Naval ships also go through the same procedure with their prizes. Historically, the arrangements for dividing the spoils varied with country, custom, and ship.

### Mangonels

Mangonels are direct-fire artillery engines that use small, round stones of lead shot for ammunition. They are powered by torsion, either from twisted thick ropes or heavy metal springs. Mangonels are used since arced fire was generally not possible aboardship. An arced artillery engine inflicts damage on two targets: the ship

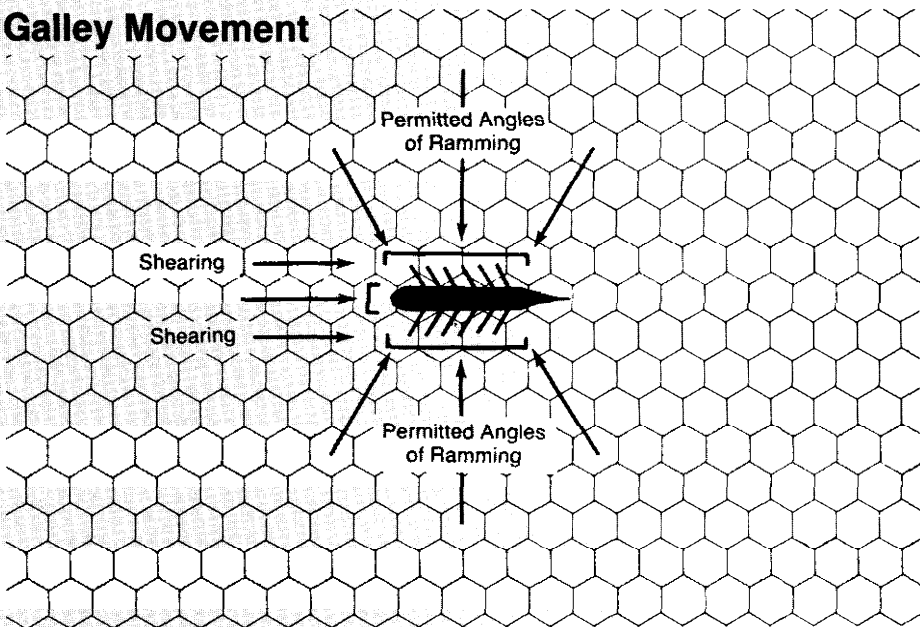
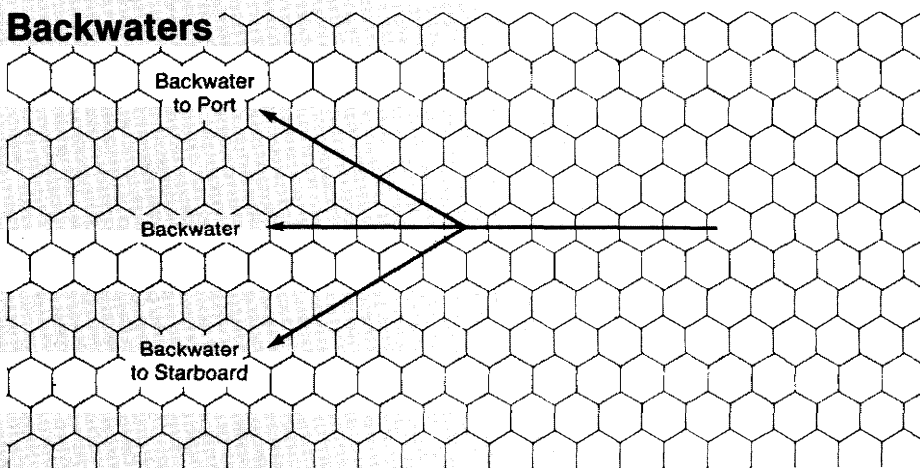
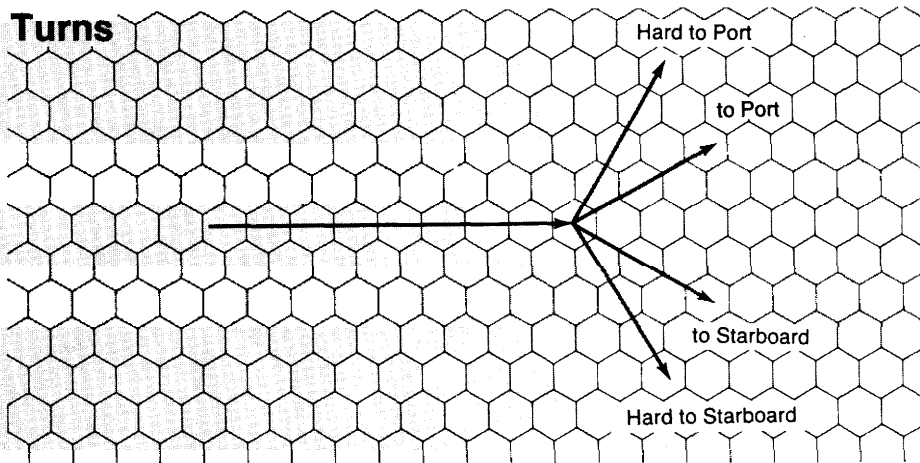

Type of mangonel	Damage		Crew		Range	Field of fire	Rate of fire
	S-M	L	min	max			
Light	2-16	3-12	2	4	¼-30"	5°	¼ or ½
Medium	3-24	4-16	4	8	¼-28"	5°	¼ or ½
Heavy	4-32	5-20	6	12	¼-26"	5°	¼ or ½

# TRAVELLER:

MANKIND  
DISCOVERS  
THE STARS

# 2300



State-of-the-Art Science-Fiction Role-Playing.

**GDW** Game  
Designers'  
Workshop  
*Since 1977*

PO Box 1646, Bloomington, IL 61702-1646



**J**ourney across the light years exploring the uncharted systems of the frontier; watch your two shadows under a double star; war against the unfathomable Kafers amid the exotic environments of alien worlds; ride the beanstalk down to the towering cities of Earth, the economic center of an ever expanding human civilization. Be a part of the new age in **Traveller: 2300**—the state-of-the-art in science fiction role-playing.

### History

**Traveller: 2300** plays against a background of Earth 300 years after the cataclysm of the Third World War. Set in a world where nations still clash, civilization has crawled back to its pre-war levels, and then beyond. The world is dominated by the Second French Empire. Earth's hundred nations have colonies among the stars. First contact happened long ago, and commerce with alien intelligences is now commonplace.

But exploration still goes on! The conquest of the stars has just begun.

### Game Systems

Playable realism. Many games which are realistic can't be played; most playable games aren't terribly realistic.

**Traveller: 2300** is both at once, balancing exquisite detail with simple, accurate game systems.

The heart of **Traveller: 2300** is its task resolution system. With it, the referee has a plethora of examples and precedents to use in any situation, and the players have a reasonable idea what their options will be on any given task. Rules cover all aspects of conflict resolution, from arguments to all-out battles. Detailed character generation, starship operations and combat, and economics make **Traveller: 2300** the state-of-the-art in science fiction role-playing. If you're playing anything else, you're behind the times.

### The Near Star Catalog

The **Traveller: 2300** universe deals with star systems within 50 light years of Earth. Extensive research and analysis has produced the most accurate star map ever made. Never before has such a monumental task been undertaken, either in gaming or in science fiction. Over 700 stars in over 500 systems, on a 22" x 25" full color map. Location, spectral type, size, and magnitude are all documented in a separate star catalog.

The local neighborhood of stars contains white dwarves, red giants, and warm yellow stars like our own. The map extends far beyond the furthest reaches of human settlement, into the realms of aliens and the unexplored. **Traveller: 2300** maps out the local neighborhood in detail never before accomplished, helping to make the game what it was designed to be—the ultimate in playable realism.

**Traveller: 2300** includes complete rules for science fiction role-playing, a complete full color map of everything within 50 light years of Sol with accompanying stellar data, and an introductory adventure set on mankind's frontier. Be a part of the New Age, with **Traveller: 2300!**



fired upon, and its own rigging and sails. The stress from a catapult would break a galley. Mangonels are subject to the same bonuses and penalties applying to other artillery engines (see page 109, DMG)

### Table descriptions

Table Ia gives basic information about each kind of galley and ship. Cost is for a new vessel of acceptable maintenance with its masts, yards, rigging, and sails, but not with artillery engines, supplies, or spare parts. Vessels of good maintenance cost an additional 5% excellent 15%, and vessels of advanced design cost an additional 30%. Thus, an acceptable corvette costs 45,000 gp; a good one, 47,250 gp; an excellent one, 51,750 gp; and, one of advanced design, a whopping 58,500 gp!

Full length is from the bowsprit to the stern (taffrail), while deck length is measured on the uppermost full deck. Beam is the width of the vessel, and (middlemost) deck width is 2-3' less. Draft is the depth of the keel below the water.

Freeboard is the distance from the uppermost full deck to the water; in galleys, this distance is measured from the lowest oarlock. Both draft and freeboard are given for a vessel at its maximum tonnage, which is how much weight a vessel can carry safely beyond the weight of itself, its masts, sails, rigging, and yards. If the vessel operates in fresh water, subtract 5% of tonnage since fresh water is less buoyant than salt water. Decks are added in the following order: (full) upper, orlop, lower, middle, (partial) quarter, forecabin, poop, and poop royal.

Galleys and ships may move in one of five directions in relation to the wind in which they can sail — four of these are for both port and starboard (e.g., port tack and starboard tack). The base speeds of the vessels may be adjusted by various factors. Vessels can sail at less than their calculated actual speed; this is simply a matter of spilling wind from the sails or of reducing the amount of sail set. On the open sea, ocean vessels sail all day and all night long. In AD&D game terms,

a mile is 176" long; thus, 3" is roughly equivalent to 1 MPH. Ships tacking on the open sea or ocean sail for several hours on one tack before switching. All movement can be diagrammed easily on hex paper, with 1 hex = 30 yards (1").

The numbers under maneuverability refer to which type of dice are rolled to determine how many rounds, plus or minus adjustments (See Tables II and III), it takes to change from one point of sail to another. This reflects time spent adjusting the sails, yards, and rigging. When maneuvering from one tack to another, the adjusted roll is tripled.

Table Ib is concerned with the fighting ability of the ships. The numbers given for defensive points can be adjusted by plus or minus 1-10% to allow for some variation within each type of ship. The emplacement of mangonels was mentioned above. Ballistas are mounted on the partial decks or on the upper deck, if there are no partials. The ship's complement is broken down into several groups. Commissioned officers are lieu-

Table Ia: Ships' statistics

	Size	Cost gp	Full length (ft)	Deck length (ft)	seam (ft)	Draft (ft)	board (ft)	Tonnage	No. Masts	No. decks	No. partial decks	No. pumps	No. boats	Base speed (")	Maneuverability (sail)
Trireme, apher.	M	4	115	0	12	3	4	50	1	0	0	0	0	9	10
Trireme, cata.	M	5	125	105	23	4	8	65	1	1	0	0	0	6	10
Quadrirème	M	25	180	155	26	5	10	320	1	1	0	0	0	6	10
Hemiolia	S	10	80	0	10	3	3	25	1	0	0	0	0	9	8
Triemiolia	M	3	90	0	12	4	4	35	1	0	0	0	0	12	10
Longship	L	30	120	100	27	8	6	425	1	1	0	0	0	24	8
River galley	S	2	60	50	15	5	3	50	1	0	0	2	0	15	6
Boat	VS	1/2	30	0	10	3	2	10	1	0	0	0	0	15	4
Cog	M	5	100	85	20	10	10	150	2	1	2	2	2	24	10
Caravel	M	13	85	75	20	7	7	100	3	1	2	2	2	30	10
Carrack	L	18	120	100	20	11	12	685	3	2	2	4	2	21	12
Galleon	L	20	135	120	35	17	20	1050	3	3	3	5	4	18	12
Naval cutter	M	15	100	90	22	6	5	190	2	1	1	2	2	24	6
Brig	M	30	100	90	25	10	6	250	2	2	2	3	2	21	8
Corvette	M	45	115	100	25	10	8	270	3	2	1	3	3	30	8
Frigate	L	60	140	120	34	15	10	610	3	3	2	4	4	27	8
SOL IV Rate	L	75	160	140	40	18	13	990	3	3	3	4	5	18	10
SOL III Rate	L	90	180	160	45	24	19	1460	3	4	3	5	5	15	10
SOL II Rate	L	105	200	180	52	27	22	2100	3	4	4	5	6	15	10
SOL I Rate	VL	120	230	200	57	30	25	2865	3	4	4	6	6	12	12
Naval transport	VL	65	230	200	60	35	20	3140	4	V	V	6	3	12	12
Cutter, small	S	3	60	50	14	10	7	40	1	1	0	1	1	21	6
Cutter, medium	M	5	80	70	19	10	7	110	2	1	0	2	2	21	8
Sloop, small	S	2	70	60	16	10	8	65	1	1	1	1	1	27	6
Sloop, medium	M	4	100	85	23	10	8	195	2	1	1	2	2	27	8
Schooner, medium	M	7	100	80	22	10	8	190	2	2	1	2	2	24	8
Schooner, large	L	14	115	100	27	10	8	310	3	2	1	3	3	24	10
Packet	L	50	140	120	24	13	10	320	3	2	2	3	3	33	8
Clipper	VL	100	220	200	33	15	5	1040	3	2	2	4	4	36	10
Cargo, small	S	25	115	100	30	15	10	390	3	1	1	2	2	21	6
Cargo, medium	M	40	140	120	35	15	10	675	3	2	2	3	3	18	8
Cargo, large	L	55	170	150	45	15	10	1325	3	2	3	4	4	15	10
Cargo, transport	VL	60	200	175	60	25	15	2660	4	V	V	4	3	12	12

V = Variable. Note that historical ships often varied widely from these given statistics, which are for AD&D game purposes only.

tenants and higher. Petty officers and mates (group I) are in the COC. No ship has more than one of each petty officer in group I except middies. Petty officers and mates of group II are not in the chain of command. Sailors are able-bodied, ordinary, and landsmen.

The prevailing practice on a ship is to divide the complement into two watches. Each watch stands three shifts on, then three shifts off. A day is divided into five four-hour shifts and two two-hour shifts (the dog watches). Half of the normal complement is necessary to sail the ship; in combat, the off-duty watch handles the artillery engines, makes repairs, and puts out fires.

Maximum additional complement tells how many marines, auxiliaries, additional sailors, or officers a ship can carry. On commercial transports, the additional complement are passengers (troops on naval transports). In both instances, the transports have four full decks.

Table Ic gives additional statistics for galleys. A bank is a line of oars ex-

tending from fore to aft. Normal oar speed can be maintained for up to four hours. Battle speed can be maintained for 60 rounds, and sprint speed for only 30 rounds. All require one hour of complete rest after the maximum time is expended. Every round of battle speed is equivalent to four rounds at normal speed; each round of sprinting is equal to eight rounds of normal speed. The rowed speeds are for any direction; if you are using hex paper, you may confine galleys to the six cross-face directions. A galley must travel a certain number of rounds on one course before it can take another. This is listed on the table as maneuverability (oar). It is affected by the level of crew ability (see the diagram on page 15).

Table II randomly assigns the level of a ship's maintenance and gives the effects of the resulting level. Adjustments to defensive points are made to each type. The chance of storm damage is to be used with Table IV. The level of maintenance may be improved by one category (poor to acceptable for instance) for every two weeks in

dry dock beyond the normal maintenance. Normal maintenance consists of dry docking the ship for one week every six months and an additional two months at the end of every three years. Failure to do so lowers the level of maintenance by one place immediately, and one place further every six months thereafter. Only a ship built with advanced design features can be returned to that level. Dry docking costs 2% of the ship's value per week. Ancient galleys are exempt from the usual need for maintenance in dry dock, since they are out of the water so much. Dry docking allows other vessels to have barnacles and weeds scraped from their bottoms.

Table III gives the crew's overall rating, the proportions of able-bodied, ordinary, and landsmen sailors, and the effects this has. A galley crew must roll twice to find out what its rating is as a sailing crew and as a rowing crew. Use one or the other rating to determine the effects. The "to hit" adjustment applies only to artillery engines. The adjustment to maneuverability is made to the rolls indicated on Tables

**Table Ib: Ships' combat & defensive abilities**

	Defensive points*			Artillery engines				Complement						
	Hull	Each mast	Rigging & sail	Bal-listas	Lt. mangonels	Med. mangonels	Hv. mangonels	Comm. off.	Petty off. I	Petty off. II	Mates I	Mates II	Sailors	Maximum add.
Trireme, aphr.	24	6	4	2	0	0	0	1	3	3	0	0	170	14
Trireme, cata.	24	8	8	4	0	0	0	1	3	3	0	0	170	35
Quadrirreme	36	10	12	8	0	0	0	1	3	3	0	0	232	70
Hemiolia	16	6	6	2	0	0	0	1	3	3	0	0	50	6
Triemiolia	8	8	8	2	0	0	0	1	3	3	0	0	74	12
Longship	30	15	7	0	0	0	0	1	1	2	0	0	50	30
River galley	12	8	4	4	2	1	0	1	3	0	1	0	20	20
Boat	6	4	2	1	0	0	0	0	0	0	0	0	16	16
Cog	20	9	10	4	0	0	0	2	4	5	2	0	20	130
Caravel	25	12	14	6	2	0	0	2	4	5	3	2	35	120
Carrack	34	10	15	8	2	2	0	3	6	5	3	5	82	300
Galleon	104	22	28	12	12	12	8	5	8	5	9	10	150	200
Naval cutter	27	9	10	6	10	0	0	1	6	4	3	4	20	20
Brig	42	10	14	12	16	12	0	3	7	4	5	8	45	96
Corvette	51	11	18	16	18	8	6	4	8	5	6	10	84	250
Frigate	60	13	21	16	20	0	6	4	11	5	6	10	84	250
SOL IV Rate	105	23	36	16	26	22	18	6	15	5	9	15	72	250
SOL III Rate	114	25	39	16	28	24	20	8	19	5	12	20	72	280
SOL II Rate	123	27	42	18	30	26	22	10	23	5	15	25	72	290
SOL I Rate	132	29	45	18	32	28	24	6	15	5	9	15	72	360
Naval transport	105	24	36	12	4	4	4	3	7	5	5	10	40	1100
Cutter, small	15	8	5	2	0	0	0	1	4	3	4	3	10	15
Cutter, medium	20	9	10	4	0	0	0	1	4	3	4	3	20	35
Sloop, small	20	10	6	4	0	0	0	1	4	3	4	3	10	25
Sloop, medium	30	11	12	6	0	0	0	1	4	3	4	3	20	75
Schooner, med.	25	12	14	6	2	0	0	2	4	3	4	3	30	61
Schooner, large	38	13	21	8	4	2	0	2	4	3	4	3	30	100
Packet	60	15	24	8	6	2	0	3	6	5	6	10	96	35
Clipper	105	18	36	10	6	2	0	3	8	5	8	12	108	220
Cargo, small	33	8	15	6	2	0	0	1	4	3	4	3	30	120
Cargo, medium	39	12	21	8	4	0	0	2	6	4	6	8	30	175
Cargo, large	75	16	27	10	6	0	0	3	8	5	6	10	30	315
Cargo transport	90	20	32	12	6	0	0	3	8	5	6	15	40	1000

\* Defensive points are a ship's hit points (see DMG, pages 54-55 and 109-110).



AND SOON I heard a ROARING WIND:  
It did NOT come ANEAR;  
But with its SOUND it SHOOK the sails,  
That were so thin AND SERE.

The upper air burst INTO life!  
AND a HUNDRED fire-flags SHEEN,  
TO AND FRO they WERE hurried ABOUT!  
AND TO AND FRO, AND IN AND OUT,  
The WAN stars DANCED BETWEEN.

From "The Rime of the Ancient Mariner"  
by Samuel Taylor Coleridge.

Illustration by Gustave Doré,  
courtesy of Dover Publications, Inc.

Ia and Ic. No roll can be reduced below 1. Whenever a ship goes from one POS to another (as shown on Table IV), the base chance for the ship to go in irons is rolled. This out-of-control condition lasts 5-30 rounds. Either indicates the sails were not set properly or it means poor synchronization of the oars.

Good officers improve crew quality through training, good discipline, and fair treatment. Landsmen take three months

to rise to ordinary, an ordinary sailor takes one year to rise to able-bodied, and an able-bodied sailor requires one year further to rise to mate. Not all ordinary sailors can rise to ABs, nor can all ABs rise to mate. Only half of those trained are able to progress to the next level of ability.

In Table IV, the effects of wind are explained. Gusts are one Beaufort number higher. The + and - under possible points of sailing indicate which courses

are possible or not. Before adjustments are made to the chance for a galley to suffer storm damage, the probability is doubled. A quadrireme of advanced design (-15%) in storm force 10 winds (30%) suffers a 45% chance of damage — not 15% or 30%. In gale and force winds, prudent captains have hatches and ports sealed, sails hauled in, yards or booms lowered, a small storm sail set, a sea anchor dropped over the side, and ensure that a sharp eye is kept

Table 1c: Galleys' statistics

	Ram?	Oar length	No. of banks	Oars/bank			Total oars	Rowers/ oar	Total rowers	Oar speed (*)			Maneuverability (oars)
				lower	mid.	upper				normal	battle	sprint	
Trireme, aphr.	Y	15'	3	27	27	31	170	1	170	18	21	24	4
Trireme, cata.	Y	17'	3	27	27	31	170	1	170	15	18	21	6
Quadrireme	Y	22'	2	27	0	31	116	2	232	12	15	18	8
Hemiolia	N	12'	2	12	0	13	50	1	50	18	21	24	6
Triemiolia	N	15'	3	12	12	13	74	1	74	18	21	24	6
Longship	N	20'	1	25	0	0	25	2	50	12	15	18	8
River galley	N	20'	1	13	0	0	26	2	52	15	18	21	6
Boat	N	5'	1	8	0	0	16	1	16	12	15	18	4



out for leaks. For every three turns of force-7 + winds, the vessel must make a roll on percentile dice to see if it has taken any storm damage. If there is damage, it occurs in the following order: loss of half of the rigging and sail (R&S) points; loss of the other half of the R&S points; loss of one-quarter of the points for the masts; loss of a mast each time further damage is done, until all the masts are gone; loss of the rudder; and, loss of a sea anchor. Unless a sea anchor has been set when the rudder is lost, the vessel turns sideways to the wind and waves, and it is swamped the next time damage is taken. Once swamped, the ship sinks in 10-60 rounds.

A sea anchor is a canvas funnel held open by crosspieces. Spars, empty water kegs open at one end, or even ship's boats can serve as sea anchors in emergencies. Two sea anchors for each step in size (VS-VL) can stop a vessel in the water. Due to their size and flotation chambers, boats have only half the chance listed of taking storm damage. After a storm, a vessel without a sea anchor might find itself hundreds of miles away from its original position in the general direction of the storm winds.

Table V lists the amount of damage done by assorted disasters, weapons, magic, and things that go splash in the night (or day). A collision is not a gentle bump against the dock; what is meant here is a situation in which two vessels crash together at three-quarters to full speed. Unless a vessel is carrying a ram, this action isn't ramming - it's colliding. If run aground on rocks or reefs, a vessel takes full damage. On sand bars, it takes one-quarter damage; on mudbanks, it takes no damage. A grounded vessel can wait for the tide to rise and float it free, but if deeper water is nearby, it can kedge itself free. Kedging may be absolutely-necessary if the vessel is left high and dry by an ebbing tide. A vessel kedges by lowering its anchor into a boat, which rows away the length of the anchor's cable and drops the anchor. The vessel then winches itself along the cable till it raises the anchor. The procedure may have to be repeated several times.

Weapons cause the damage shown. Ships are AC 0 due to the heavy type of construction used. Galleys are AC 5 due to their flimsy build. If this seems unrealistic,

remember that the U.S.S. *Constitution* got the nickname "Old Ironsides" because cannonballs literally bounced off its sides! Sailing vessels cannot carry arced artillery engines, as they would damage their own rigging and sails. Galleys, on the other hand, would be ripped apart by the recoil of anything heavier than a ballista.

Spells listed as "+ F" cause the damage rolled and set a fire equal in points to the roll. Spells listed as "(F)" set fires only (doing the number of points shown). A *gust of wind* cast in a hostile fashion has a chance of putting a vessel under sail in irons (for 5-30 rounds) equal to 10 times the level of the caster. A vessel running into a *wall of force* dispels the *wall*.

Sea monsters that attack by ramming also have a chance of capsizing a vessel, but only on their first successful ram. Later successful rams cannot capsize the vessel. Very small boats suffer an additional 10% chance of being capsized, small vessels +5%, large vessels -5% and very large ships -10%. Giant octopi, their cousins, and giant sea snakes attack by crushing the hull. The giant cephalopods need to wrap a certain number of tentacles around the vessel for a few rounds before any damage can occur.

Table V does not list the numerous intelligent marine races, which usually attack vessels that are becalmed, anchored, or moving very slowly. However, even vessels sailing at full speed may be stopped and attacked. Since sound travels so well underwater, vessels with noisy crews or with their pumps working attract more attention. Vessels are stopped either by snagging the hull with a large net acting as a sea anchor, or by attaching two sea anchors - one to the rudder (ripping it out) and one to the side of the ship (making the ship turn in circles). The attackers may then attach more sea anchors at their leisure to stop the ship. Both of these methods work 50% of the time. Ancient galleys are hard to snag since their hulls are so clean; furthermore, they have two steering oars. They and the other galleys can continue to steer by using their oars. But the large net that can't snag an ancient galley's hull can foul the oars.

Once a vessel is stopped, the attackers usually board it. At these close quarters, a vessel's heavier artillery engines are use-

less, but ballistas can still be effective, since they are swivel-mounted. In areas where hostile marine races are known to operate, a wise captain may take the obvious precautions of keeping boarding nets hung and increasing the lookouts and guards. Boarding nets are loosely hung from the yards and fastened to the deck. Because they are loose, they are hard to climb or cut. In any campaign world, many maritime powers should be paying tribute to hostile marine races. Pirates may be in alliance with those races.

Table VI gives the distribution of damage caused by weapons. Galleys that do not have their masts raised cannot take mast or R&S damage; those hits are misses in that case. Damage caused by monsters is restricted entirely to the hull. On the other hand, magical powers can be aimed to some degree. The caster or user must specify in which area or defensive point category of the target ship the effect affects. Some targets are very difficult to hit because they are protected by the side of the vessel, are only briefly visible, or can only be reached through a very narrow opening. The whipstaff controlling the rudder in medieval ships is entirely below decks. The wheel of medium-sized and larger ships of later periods is partially below decks. In both cases, orders to the quartermaster are relayed or simply shouted. In galleys and small/very small ships, however, the persons at the tiller or steering oar(s) are exposed.

Table VII deals with towing. The towing and the towed vessels should move in the same direction. Add their actual speeds together and subtract the percentage shown. A ship can be towed by all of its boats rowing together at a maximum speed of 1 mph.

Table VIII deals with the effects of fire, damage to the three defensive point categories, repairs, and their costs. Fire is a wooden vessels deadliest enemy. It takes two gallons of water to extinguish one point of fire. If a ship were hit with a *fireball* cast by a 12th-level magic-user and the ship failed its saving throw, then the *fireball* does six points damage due to the explosion and sets a six-point fire. Besides buckets and pumps, there are several spells that are effective in fire-fighting (*create water*, *cloudburst*, etc.).

The second part of Table VIII deals with hull damage and its effects. The percent of the hull damaged is also one-half the percentile chance for the vessel to start sinking, which is roiled every turn. Regardless of the cause, a vessel takes 10-60 rounds to sink. Serious damage above the waterline can cause a vessel to start breaking up and sinking. However, by making temporary repairs, the threat of sinking can be countered. There are two sorts of temporary repairs to the hull: fothers and patches. A fother is a reinforced tarred piece of canvas that is positioned over a hole by ropes running under the hull. The pressure of the water trying to flow through the

**Table II: Ships' maintenance and effects**

	Very poor	Poor	Acceptable	Good	Excellent	Advanced design
Naval	1-5	6-10	11-40	41-80	81-97	98-00
Pirate/Buccaneer	1-20	21-40	41-60	61-80	81-98	99-00
Privateer	1-10	11-20	21-46	47-72	73-98	99-00
Commercial	1-15	16-30	31-55	56-85	86-95	96-00
Effect on speed	-15%	-10%	-5%	-	+5%	+10%
Effect on def. points	-10%	-5%	-	-	+5%	+10%
Effect on maneuverability	+2	+1	-	-	-1	-2
Effect on chance of storm damage	+20%	+10%	-	-	-5%	-15%

hole keeps the fother in place. If the damage is due to weapons or collision, then one-quarter of the damage to the hull is presumed to be below the waterline. Hull damage from ramming or running aground is entirely below the waterline.

Above the waterline, the carpenter and carpenter's mate can easily place a wooden patch. When the hole is below the waterline, however, a hole can only be patched if the ship is careened. Careening a ship lays it over on its side until the keel is almost at the surface. This is done by moving the supplies and cargo over to one side of the ship. Careening should only be done in very quiet waters when the air is very still. A sudden gust can make the ship "turn turtle" – in other words, sent the keel straight up and the masts straight down. Ancient galleys can be beached for patching. Since fothers leak, the pumps must be worked full-time by four of the crew if used. Permanent repairs alone restore hull defensive points and must be done in dry dock. The cost is equal to 40% of the ship's value multiplied by the percent of hull damaged; this action takes 4-16 days.

To illustrate the rules given above, consider the following example. A clipper with 105 hull defensive points takes 21 points of damage (20%) due to running over a reef. Every turn thereafter, it must roll over 10 on a percentile die or start sinking. However, the captain prudently laid out some dozen fothers on the upper deck ready to use. As a result, all of the damage is fothered at the end of 10 rounds. Fortunately for the ship, it did not fail any of its "sinking" rolls while the

fothers were being placed. A few days later, the clipper makes port, unloads its cargo, and heads for dry dock for 10 days. The original cost of the clipper was 100,000 gp, 40% of which is 40,000 gp – which, multiplied by 20% hull damage, is 8,000 gp! Needless to say, the captain will be more wary of reefs in the future, if she is still captain.

Damage to the masts is very serious. Lose a mast and not only does the vessel lose that mast's share of the rigging and sails, but it also automatically goes in irons. Obviously, a galley without the mast raised cannot suffer damage to its mast. The points given on Table Ib are the points for a single mast. If the damage distributed among the masts is equal to or greater than a single mast's defensive points, then there is a 33 1/3% chance of losing a mast per round (1-2 on 1d6). At

sea, up to three fourths of the total mast points can be repaired. This is because most vessels carry a smaller set of spare masts, yards, and sails called the jury rig. Even boats carry a few extra yards of sailcloth. At dockside, a completely new set of masts and yards can be installed and the jury rig stowed away again. The cost of a ship's mast repairs is 40% of the ship's value multiplied by the percent of mast damage; this action takes from 1-4 days. A galley's mast repairs cost 10% of its value multiplied by the percent of damage. Masts, being made of several of the straightest, tallest, and strongest whole tree trunks, are quite expensive.

Damage to the rigging and sails causes a proportional loss of speed. A vessel normally carries enough canvas and rope to replace half its rigging and sail points. In port, new sails cost only 20% of the

**Table III: Crew ability & effects**

	Very poor	Poor	Acceptable	Good	Excellent
Naval	1-5	6-10	11-70	71-90	91-00
Pirate/Buccaneer	1-15	16-30	31-90	91-98	99-00
Privateer	1-5	6-15	16-80	81-90	91-00
Commercial	1-5	6-15	16-80	81-95	96-00
Landsmen	85%	70%	55%	40%	20%
Ordinary sailors	10%	20%	30%	40%	50%
Able-bodied sailors	5%	10%	15%	20%	30%
Effect on "to hit" scores	- 2	- 1	-	-	+1
Effect on maneuverability	+2	+1	-	- 1	- 2
Base chance to go in irons*	20%	10%	5%	2%	1%

\* Check "in irons" chance when changing points of sail, when careening (for turning turtle), or when ship is hit by a sudden natural gust or squall. Triple this chance when changing tack.

**Table IV: Wind and its effects**

Beaufort force No.	Name	Wind speed (MPH)	Effect on sailing speed	% Chance of storm damage	Possible points of sailing (POS)				
					Tacking	Reaching	Broad reaching	Running free	Running bfr. wind
0	Calm	0	0	-	-	-	-	-	-
1	Lt. air	1-3	1/4	-	-	-	-	+	+
2	Lt. breeze	4-7	1/2	-	-	-	+	+	+
3	Gentle breeze	8-12	3/4	-	+	+	+	+	+
4	Mod. breeze	13-18	Full	-	+	+	+	+	+
5	Fresh breeze	19-24	Full	-	+	+	+	+	+
6	Str. breeze	25-31	+5%	-	+	+	+	+	+
7	Fresh gale	32-38	+10%	5	+	+	+	+	+
8	Gale	39-46	+15%	10	+	+	+	+	+
9	Strong gale	47-54	+20%	20	-	+	+	+	+
10	Storm	55-63	+25%	30	-	-	+	+	+
11	Storm	64-72	+30%	40	-	-	-	+	+
12	Hurricane	73-82	+35%	50	-	-	-	-	+
13	Hurricane	83-92	+40%	60	-	-	-	-	+
14	Hurricane	93-103	+45%	70	-	-	-	-	+
15	Hurricane	104-114	+50%	80	-	-	-	-	+
16	Hurricane	115-125	+55%	90	-	-	-	-	+
17	Hurricane	126-136	+60%	100	-	-	-	-	+

+ indicates that this point of sail may be used.



# EVERYTHING YOU NEED TO START A GALACTIC WAR



Miniatures come unassembled and unpainted.

Take command of a Klingon battlecruiser, Romulan warbird, or Gorn raider and pit yourself against the mighty warships of Star Fleet with this exciting new game from FASA. The **STAR TREK Starship Tactical Combat Game** is actually two games in one. First, it's a boardgame titled "Star Fleet Command And Staff College; Starship Tactics", and second, it's a roleplaying game titled "Command And Control". Starship movement, weapons, shields, and damage repair are presented in a three-part, learn-as-you-go format so that players are not bogged down with lengthy, complex rules systems.

Each game includes all the rules, charts, dice, and playing pieces (over 300 counters) needed to play. Don't wait. Start a galactic war today with **STAR TREK Starship Tactical Combat Game**. (2003)

To add to the excitement and adventure, FASA also produces 1/3900 scale metal starship miniatures (*Enterprise* is approximately 3" long) for use with the starship combat game or as collectibles. These finely detailed miniatures (some are pictured above) add another dimension to your gaming sessions and increase the "fun-factor" to levels "where no man has gone before". If you're going to start a galactic war, why not go all the way and include some of the FASA Star Trek Starship Miniatures, winners of both the 1985 and 1986 H.G. Wells Awards for best miniatures.

## STAR TREK IV SOURCEBOOK

The **Star Trek IV Sourcebook** contains detailed information on the "Politics of Genesis Project", "State of the Federation", "Uniform Code of Military Justice", the many aliens shown in the movie, prototype ships, articles on the sovereignty of member states, a review of security procedures, a timeline of *STAR TREK* history, and where FASA products fit in. The real highlight of this book is the 16-page color section depicting alien members of the United Federation of Planets and giving brief descriptions of their origins.

The **Star Trek IV Sourcebook** is a must for the serious fan/gamer who wants to keep up with the ever-changing universe of Star Trek. (2224)

Send check or money order to:

FASA Corporation  
P.O. Box 6930  
Chicago, IL 60680



Star Trek is a registered trademark of Paramount Pictures Corporation  
Copyright © 1986 Paramount Pictures Corporation  
All Rights Reserved.

Name \_\_\_\_\_ (Please Print)  
Address \_\_\_\_\_  
City, State, Zip \_\_\_\_\_

Quant.	Stk #	Title	Price	Total
_____	2003	Star Trek Starship Combat Simulator Game	\$20.00	_____
_____	2224	Star Trek IV Sourcebook	12.00	_____
_____	2501	USS Enterprise (New)	4.50	_____
_____	2502	USS Reliant (Cruiser)	4.50	_____
_____	2503	Klingon D-7 (Battlecruiser)	4.50	_____
_____	2504	Romulan Bird of Prey (Cruiser)	4.50	_____
_____	2505	USS Enterprise (Old)	4.50	_____
_____	2506	Regula I Space Laboratory	4.50	_____
_____	2515	Romulan Winged Defender (Cruiser)	4.50	_____
_____	2517	USS Excelsior (BattleShip, ST III)	9.00	_____
_____	2518	Klingon L-42 Bird of Prey (Frigate, ST III)	4.50	_____
_____	2519	USS Grissom (Research Vessel, ST III)	4.50	_____
_____	2523	Kobayashi Maru (Freighter)	4.50	_____
_____	2524	Romulan Gallant Wing (Cruiser)	4.50	_____
_____	2526	USS Baker (Destroyer)	4.50	_____
_____	2527	Romulan Nova (BattleShip)	9.00	_____
_____	2528	Romulan Bright One (Destroyer)	4.50	_____
_____	2529	Klingon L-24 (BattleShip)	9.00	_____
			Subtotal	_____
			Shipping & Handling	32.10
			Total	_____

VISA  MASTERCARD  DISCOVER

CARD NUMBER

NAME OF CARDHOLDER \_\_\_\_\_

EXP DATE \_\_\_\_\_





ships value multiplied by the percent of R&S points lost. The reason for the high cost is that the sails must be custom-fitted to a ship. A galley's sails and rigging cost 10% of its value. If a vessel must have repairs made to two or three defensive point categories, the repairs take as long as the longest of the two or three; the time for one is not cumulative with the

time for another. While in dry dock, a mast can be replaced and the sailmakers and riggers can make new sails and rigging and work on hanging them.

Table IX contains miscellaneous tidbits. Raising an anchor involves winching it up with the capstan. Getting under way is how long a vessel at rest takes to reach full sailing speed, if currently possible.

A vessel in irons (as noted above) is temporarily out of control. How long the vessel stays in irons depends on how quickly the cause is remedied. For the loss of a mast or a poorly executed maneuver, the vessel is in irons for 5-30 rounds. If a vessel loses its captain, there is a 25% chance of going in irons. Once in irons, the ship stays so until the person next in the COC takes command. With the loss of the quartermaster at the helm, there is a 50% chance and the vessel is in irons until a quartermaster, master's mate, the sailing master, a middle, or a commissioned officer takes the wheel. Once in irons, a vessel has no control over its course, cannot fire its artillery engines, and does a fair job of imitating a sitting duck.

Vessels take from 10-60 rounds to sink, but 10 rounds is enough time to launch one boat. Shipping oars means pulling them into the galley; this action takes 1-4 rounds. Shipping oars must be done on the side of a galley which is about to dock or attempt an oar rake. Which vessel rakes and which is raked depends on which can ship their oars; both may ship them quickly enough, but both may also lose their oars.

The actual speed of a sailing vessel is calculated in the following order. The base speed is adjusted by the level of maintenance. The effects of the wind are added or subtracted. If damage has been sustained to the rigging and the sails, speed is reduced by the percent of R&S points lost. A *gust of wind*, cast in a helpful fashion, adds another 5% to the speed of the ship for five rounds. Cast in a hostile fashion, the spell has a chance of putting the target ship in irons.

Table Xa, b, and c are for use when a ship is encountered. These tables randomly select a ship appropriate for the area. The initial distance of the encounter can be as much as 50 miles in clear daylight to as little as a few yards on a moonless or foggy night. On Table Xa, roll for class of ship first; Table Xb gives the number of ships appearing. Table Xc is there to add spice.

**Table V: Amount of damage by cause**

Source of damage	Damage done*
Collision (hull 75%, mast 25%)	5-30
Ramming (hull 100%)	10-60
Run aground (hull 100%)	10-100
Ballista	1
Mangonel, light	2
Mangonel, medium	3
Mangonel, heavy	4
Catapult, light	4
Catapult, heavy	6
Trebuchet	16
<i>Bigby's clenched fist</i>	1/round
<i>Call lightning</i>	1½ + ½ per level + F
<i>Chain lightning</i>	½ per HD + F
<i>Disintegrate</i>	2
<i>Fireball &amp; delayed blast fireball</i>	½ per HD + F
<i>Firestorm</i>	(F:3)
<i>Flame strike</i>	(F:4)
<i>Gust of wind</i> (hostile)	(in irons)
<i>Horn of blasting</i>	18
<i>Incendiary cloud</i>	(F:½ per 6hp damage done)
<i>Lightning bolt</i>	½ per HD + F
<i>Meteor swarm</i> (2' sphere)	3 each
<i>Meteor swarm</i> (1' sphere)	1½ each
<i>Wall of fire</i>	(F:2½)
<i>Wall of force</i>	As per collision

\*Defensive points damage; consult Table VI if necessary, and Table VIII for effects of fire.

Monsters	Hull damage*	% Chance to capsize
Afanc (R)	3-12	15
Archelon ischyras (R)	3-12	7
Crocodile, gt. (R)	2-8	7
Dinichthys (R)	2-8	10
Dragon turtle (R)	3-12	12-14
Elasmosaurus	-	15
Elemental, water (R)	d4 per 4HD	2 per HD
Kraken (C: 6 tentacles)	5-20/rd.	0
Mososaur (R)	3-12	12
Mottled worm	-	15
Narwhale	-	5-7
Nothosaur (R)	3-12	14
Octopus, giant (C: 6 tentacles)	2-8/rd	0
Plesiosaur (R)	5-20	20
Sea dragon (lung wang) (R)	3-12	11-13
Sea snake, giant (C)	2-8/rd	0
Sea turtle, giant	-	15
Shark, giant (R)	3-12	10-15
Squid, giant (C: 8 tentacles)	3-12/rd	0
Tennodontosaurus (R)	2-8	10
Verme (R)	5-20	20
Whale (R)	d4 per 4HD	2 per HD

(R) indicates that ramming is used.

(C) indicates that crushing (with a number of appendages) is used.

\* As per DMG, pages 54-55 and 109-110.

**Table VI: Damage distribution (weapons only)**

	d100 Roll
Rigging & sails	1-40
Masts	41-70
Hull	71-100

**Table VII: Towing (% adjustment)**

Towed size	Towing size				
	V	S	M	L	VL
V	50	-	-	-	-
S	75	50	25	12	6
M	87	75	50	25	12
L	93	87	75	50	25
VL	96	93	87	75	50







Day after day, day after day,  
We stuck, nor breath nor motion;  
As idle as a painted ship  
Upon a painted ocean.

Water, water, every where,  
And all the boards did shrink;  
Water, water, every where,  
Nor any drop to drink.

From "The Rime of the Ancient Mariner"  
by Samuel Taylor Coleridge.

Illustration by Gustave Doré,  
courtesy of Dover Publications, Inc.

Ships in distress can suffer a lack of water or food, or a loss of materials for repairs. They can also be lost or under attack. If a shipwreck is rolled, it can be beached, shoaled, or shored on a reef or rocks, with or without survivors. (And are they really survivors or are they dreaded lacedons?) Alternately, the ship could have already sunk, and the encounter is with survivors in the water, boats, or rafts. An abandoned ship could be unharmed, a la Marie Celeste.

During wartime, the number of privateers increases dramatically as pirates seek out pardons and letters of marque. One in six fishing or merchant ships may carry letters of marque "just in case." Commercial ships are very flexible: one day a ship fishes, but on the next, it carries cargo and passengers or goes smuggling. An armed clipper carries twice as many artillery engines as normal, extra crew, lots of marines, and no cargo. Privateer merchant ships are both bait and trap. The idea is to "surrender" quickly, then attack the en-

emy when it heaves to alongside with concealed crew, marines, or spellcasters.

#### Additional notes

Before using the naval system in this article, decide what types of vessels you want to include in your world. If the campaign has an ancient flavor, then use the ancient galleys for warships, pirates, and privateers, and the cog as a merchant ship. Medieval settings should use the cog, caravel, carrack, and galleon. Barbarians, especially the ones patterned after the Vikings, should use the longship. The more advanced types of commercial small and medium ships are suitable for larger civilized nations that are noted for their nautical skills. The advanced types of warships should be as rare as they are expensive. The packet and clipper can be used by highly advanced cultures – perhaps nonhumans such as the elves of Tolkien's novels, famed for shipbuilding and maritime skills. Think about where the intelligent marine races are located

and what their political relations are.

Next, create a few vessels to have on hand for the characters to encounter. Give each ship its own sheet of paper and note its statistics, defensive points, level of maintenance, crew, and other important numbers. Figure the actual speed of the vessel for various wind speeds so that the information is on hand. Determine what amounts of damage to the rigging, sails, and the hull represent increments of 10%; these are important for figuring loss of speed and chance of sinking. The more detailed a ship's sheet, the less time spent in looking up the tables instead of playing. Use the other side of the sheet for notes on the vessel's complement. Don't be discouraged by the time spent doing this; this is equivalent to designing an NPC party and a small dungeon. Besides, you only have to do it once.

For ship-to-ship battles, you won't need dice as often as you'd think. With large numbers of rolls for the same group of artillery engines, use the following

method. A zero-level or 1st-level fighter needs to roll a 20 to hit AC 0. That is a 5% chance to hit, and each +1 or -1 "to hit" is another 5% more or less. This figure is also the percentage of the possible total damage that can be done. Suppose a first-rate ship-of-the-line fires off a broadside (half of its artillery engines) at another large ship. If the crew doing the firing is zero or 1st level, and if there are no other modifiers, then 5% of the total

possible damage is inflicted, or all of 7 points of damage ( $6.55 = .05 \times 131$ ). At close ranges, almost all of artillery engine shots hit their targets. Massed missile fire can be handled in the same way. Consider the effects of weapons fire up to 10 rounds at a time, but don't forget unusual events, offensive spells, or fire.

Finally, here are a few more words on basic naval tactics. In small engagements, in squadrons or single combat, line battle

formation is almost never used. Instead, the ships maneuver independently, trying to gain the favored position off an enemy's stern to deliver one or more broadsides to the stern. The stern and the bow are relatively defenseless, since there are only four to six stern chasers and two or four bow chasers. Crossing an enemy's bow is not favored, since there is a chance of miscalculating the maneuver, which results in a collision. The enemy ship may also swing its bow at the last moment and deliver its own broadside or gain a position on the attacker's stern as it sails past. A ship should flee a battle if it is not doing well; the attacking ship may not be able to pursue. A ship pursued by an obviously superior foe should run for shallow water if it has a draft less than its pursuer. Making several maneuvers that the pursuer must follow may put the hunter in irons, leaving it briefly defenseless.

It should be fairly easy to get PCs living near a coast or on islands to go to sea. Just hit them with a blockade, a pirate raid, a marauding sea serpent, or the like. For the thalassophobes (look it up) in your campaign, you may have to introduce a full-scale embargo of some product they need. You might tempt the high-level characters in the campaign with the notion of a ship or two instead of a keep or a castle. And you can mention faraway islands where riches are just waiting. . . .

---

#### Table VIII: Effects of fire

**Fire:** 2 gallons puts out 1 point of fire. 2 crewmen on a pump put out 1 point of fire/round. 4 crewmen on a pump put out 4 points of fire/round. 8 crewmen on a pump put out 12 points of fire/round.

A fire doubles in size every 4th round if it is not fought.

**Hull:** percentage hull damaged divided by 2 = percentage chance to start sinking.

3 crewmen can fother 1 point of damage in 1 turn.

1 carpenter can patch 1 point of damage in 2 turns.

Collision and weapons:  $\frac{1}{4}$  damage below waterline; ramming and grounding: all below.

Permanent repairs cost 40% of the ship's value times the percentage of hull damage, and take 4d4 days in dry dock.

**Masts:** If the damage to the masts equals or exceeds a single mast's points, then there is a  $33\frac{1}{3}\%$  chance per round of losing a mast; if a mast is lost, the ship goes in irons.

It takes 1 crewmen 1 turn to repair 1 point of damage to a mast.

Up to 75% of all mast points can be restored at sea. Permanent repairs cost 40% of the ship's value (10% for galleys) times the percentage of mast points lost. The repairs take 1d4 days at dockside.

**R&S:** The loss of a mast takes with it a proportional amount of R&S points.

The percentage of R&S lost = the percentage loss in speed.

It takes 1 crewmen 1 turn to repair 1 point of damage.

Permanent repairs cost 20% of ship's value times the percentage of damage and take 3d4 days.

Repairs to a galley's R&S cost 10% of value times the percentage of damage done.

**Oars:** A full set costs 40% of a galley's value to replace.

---

#### Table IX: Miscellaneous items

Raise anchor: 3-18 rounds      Heave to: 2-8 rounds      Sinking: 10-60 rounds

Get under way: 1-6 turns      In irons: 5-30 rounds

*Gust of wind*, hostile: (level of caster  $\times$  10) = % chance to put in irons

*Gust of wind*, friendly: +5% sailing speed for 5 rounds.

Actual speed = [(Base speed + Maintenance adj.) + Wind adj. - Damage adj.] + *gust of wind* adjustment (friendly)

---

#### Table Xa: Frequency of ship encounters

	Coast or archipelago	Semi-enclosed or landlocked	Open sea	Ocean
Fishing	1-40	1-25	1-15	1-5
Merchant	41-70	26-60	16-55	6-55
Naval	71-85	61-80	56-80	56-85
Pirate/Buccaneer	86-90	81-90	81-90	86-95
Privateer	91-00	91-00	91-00	96-00

---

#### Table Xb: Number appearing

	d10 roll		
	1-7	8-9	10
Fishing	1-6	3-18	5-30
Merchant	1-4	2-8	3-12
Naval	1-4	2-8	8-48
Pirate/Buccaneer	1	2-3	3-4
Privateer	1	1	2-3

#### Inspirational reading

Baker, William A. *The Lore of Sail*. (1983)

Blackburn, Graham. *The Illustrated Encyclopedia of Ships, Boats, Vessels and Other Water-Borne Craft*. (1978)

Casson, Lionel. *Ships and Seamanship in the Ancient World*. (1971)

Cucari, Attilio. *Sailing Ships (1976)*

Forester, C.S. *The Hornblower series*.

Melville, Herman. *Billy Budd*, *Omoo*, *Typee*, and (of course) *Moby Dick*.

#### Inspirational listening

The Clancy Brothers and Tommy Makem. "Sing of the Seal." (Columbia)

Lomax and Kennedy, eds., "Sailing Men and Serving Maids." Vol. 6 of the *Folksongs of Britain* (Caedmon)

Killen, Louis. "50 South to 50 South:

Louis Killen on the Cape Horn Road."

Roberts, John, and Tony Barrand. "Across the Western Ocean." (Swallowtail)

---

#### Table Xc: State of encountered ship (if encountered singly)

d100	State of ship
1-79	Normal
80-87	In distress
88-93	Plague
94-97	Shipwreck
98-99	Mu tiny
00	Abandoned

# Children of the Deep

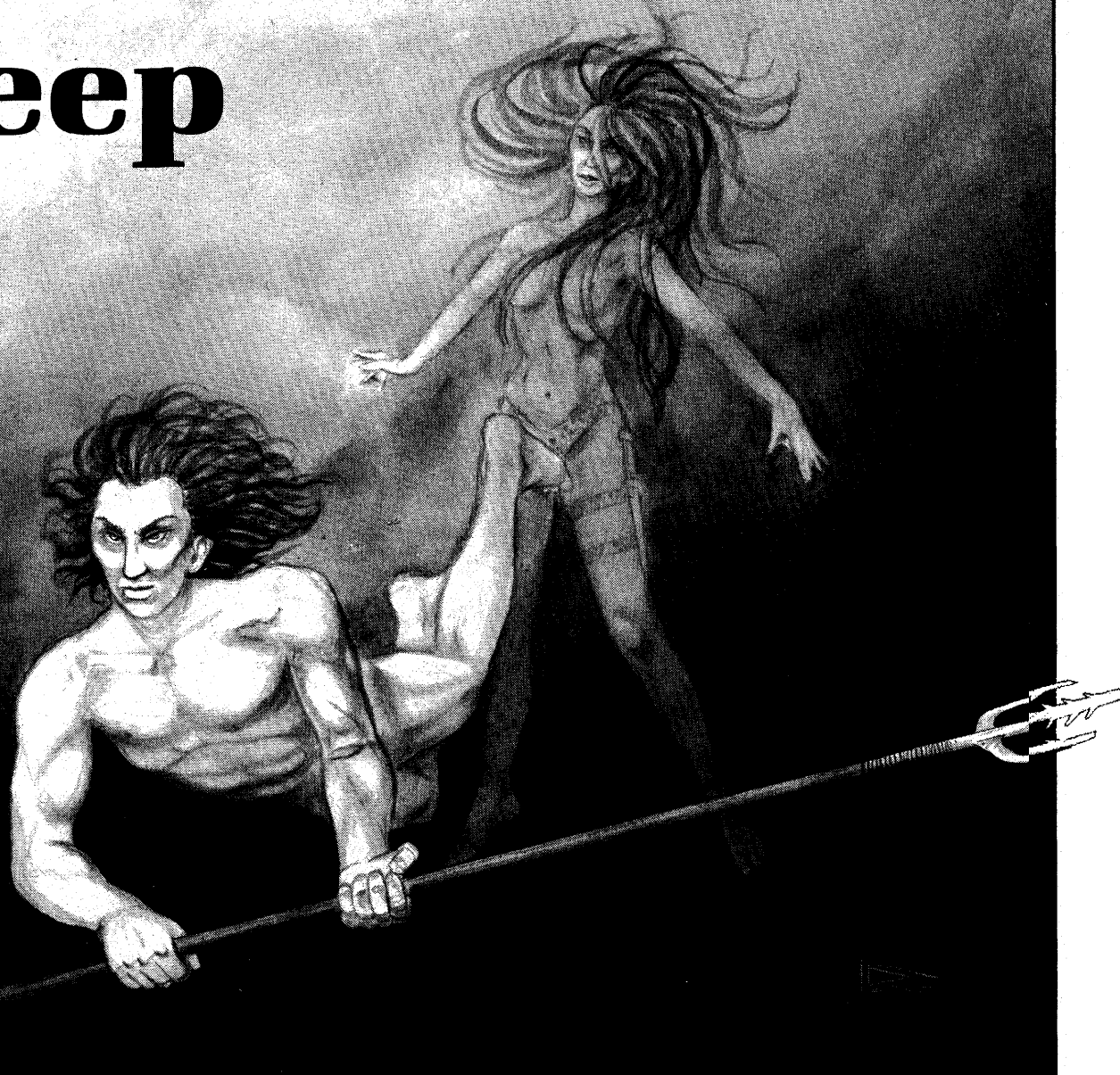

## *Aquatic elves in the AD&D® game*

by Todd Mossburg

In the AD&D® game, many characters miss out on unlimited amounts of wealth and adventure because they can't swim. Oceanic adventures are challenging for medium- and high-level player characters, but without the proper equipment, a group's first sea voyage is likely to be its very last. This keeps gamers from utilizing the ocean's full potential in the campaign.

Both the *Players Handbook* and *Unearthed Arcana* overlook the possibility

of having amphibious player characters. Using the *Dungeon Masters Guide*, *Players Handbook*, *Unearthed Arcana*, *Legends & Lore*, and *the Monster Manual*, I've compiled the statistics necessary for the solution to this problem: the aquatic elven race. Some of the information below is reiterated from these sources, but now collected together in one place. Additional material converting this race into a player character or NPC race has been added. The DM should determine whether the use of this character is appropriate to the campaign.

### **Aquatic elves: an overview**

Aquatic elves are known as sea elves, though some high elves who live near oceans are also called sea elves. Closely related to their land cousins, they can even interbreed with land elves and humans. Humanoid in appearance, they have gill slits on the throat, webbed fingers and toes, silver-green skin, and green, cyan, or blue hair of rough texture. They have deep blue or turquoise eyes, and pointed ears.

Aquatic elves prefer warm, quiet sea waters, particularly those overgrown with



seaweed and other marine vegetation. They usually lair in large caverns in lagoon bottoms (often fashioning their own caves) and enjoy reefs near peaceful sea coasts. They trade with land elves for metal goods, which aquatic elves are unable to forge underwater; in exchange, the aquatic elves offer coral jewelry, fish, treasures scavenged from shipwrecks or sacrifices, and other gifts of the sea.

Because they have been so long separated from their land-based cousins, aquatic elves rarely distinguish one race of land elves from another and extend at least tolerance and good will toward all but drow (whom the aquatic elves view with antipathy). The land elves return the very same feelings. Those who are born of an aquatic elf and land elf are at least tolerated, as are those born of a human and an aquatic elf.

Though they prefer the company of elves, aquatic elves tolerate peaceful humans. Unfortunately, fishermen and sailors sometimes slay aquatic elves in the belief that the latter are sahuagins. Nonetheless, aquatic elves are known to save drowning sailors. These elves are quite friendly towards dolphins, with which they can communicate, and can summon dolphins with their cries if the latter are within 240 yards. Aquatic elves harbor a great hatred for sharks and sahuagin, who are their mortal enemies, and attack them if at all possible. Ixitxachitl and kopoacanth (gargoyles) are usually too rare to be much of a threat, though the more common kaolinth (aquatic hobgoblins), merrow (aquatic ogres), and scraggs (marine trolls) present a real danger in some areas. Kaolinth pursue aquatic elves with all the fury that their land-based cousins pursue land elves. Mermen and locathah are neutrally regarded; tritons and marine storm giants are tolerated by and sometimes live in close harmony with aquatic elves. Sea hags and aquatic elves rarely meet, since the former prefer dismal lairs to the serene beauty of the latter's realm. Lizard men are generally disliked for their barbarism. The hated lacedons cannot paralyze aquatic elves, just as land elves are immune to the paralyzing touch of ghouls.

Aquatic elves often capture and train certain marine creatures for use as steeds, beasts of burden, and pets. Sea horses, sea lions, giant turtles, narwhales, swordfish, and the like are sometimes found in association with communities of these elves.

The shy aquatic elves are able to hide in marine vegetation so well as to become invisible to onlookers. They can identify dangerous marine life such as strange-weed 90% of the time, and they know how to swim quietly through the water so as not to attract the attention of sea-going predators.

The weapons of preference for this undersea race include the trident, spear, and combat net. Other weapons useful in undersea environments are also used,

though to a lesser extent: daggers, knives, darts (10' short, 20' medium, and 30' long range), thrusting and stabbing polearms (pikes and military forks), and short swords. Javelins and harpoons are sometimes used by aquatic elves on surface missions, and undersea crossbows (30' short, 60' medium, and 90' long range; otherwise as per light crossbows). Adventuring aquatic elves may learn other weapons if they stay on land often enough, but this is rare.

### Aquatic elfen PCs

A character of aquatic elfen stock can opt to be an assassin, cleric, fighter, thief (but not a thief-acrobat), fighter/cleric, or fighter/thief. Aquatic elfen thieves have all the bonuses and penalties to their skill rolls as do any other elves (*Players Handbook*, page 28), except for a -20% modifier to climb walls. They are used to swimming over obstructions, not climbing over them. Aquatic elves also have a +15% bonus to hear noise when underwater, regardless of class. Though aquatic elves cannot cast magical spells, they can use certain scrolls and magical devices that can be used by any other race or class, and aquatic elfen thieves may cast spells from scrolls if of sufficient level. The starting ages for aquatic elfen characters is the same as for other elves (*DMG*, page 12-13). Ability score maximums and minimums are as per the *Players Hand-*

*book*, page 15; a +1 comeliness bonus is also applied.

All aquatic elfen characters can speak the following languages in addition to that of their chosen alignment: common, elvish, delphinese, locathah, merman, sahuagin, and triton. Aquatic elfen characters of above 15 intelligence are able to learn one additional language for every point of intelligence over 15; for example, a character with an 18 intelligence score could learn three additional languages.

When employing a spear or trident, aquatic elfen characters gain a +1 bonus to hit on attacks. They can swim silently on a roll of 1-5 on a d6, hide in marine vegetation with 80% success (+1% per experience level), have a 90% resistance to *sleep* and *charm* spells, possess infrared vision up to 60' in the sea and 120' above water, and can detect secret and concealed doors as well as land elves (note concealed doors 1 in 6 times if passing by them; note secret doors 2 in 6 times and concealed doors 3 in 6 times if searching for them).

Aquatic elves have excellent hearing and vision underwater, so the aquatic elves are only surprised on a 1 in 6 chance when underwater. They have normal chances for surprise when above the watery depths. Because of their gills, these characters may breathe air or water at will for unlimited duration. However, for every full day spent away from water, an aquatic elf must make a system-shock roll or else

**Table 1: Racial adjustments to ability score**

Race	Penalty or bonus
Aquatic elf	+1 to dexterity, - 1 to constitution
Aquatic elf/half-elf	+1 to dexterity, - 1 to constitution
Aquatic half-elf	None

**Table II: Age categories**

Races	Young adult	Mature	Middle-aged	Old	Venerable
Aquatic elf	75-150	151-450	451-700	701-1000	1001-1200
Aquatic elf/half-elf*	125-200	201-550	551-900	901-1200	1201-1400
Aquatic half-elf	24-40	41-100	101-175	176-250	251-325

\* Excludes aquatic elf/drow parentage; in this case, use age categories for drow elves (*DMG*, page 13) +50 years after young adult age.

**Table III: Character race class limitations (by level)**

### Aquatic elves

Ability score	Cleric	Fighter	Thief	Assassin
15	7	6	10	8
16	8	6	11	9
17	9	6	12	10
18	10	7	U	10
18/75		8		10
18/90		9		10
18/99		10		11 <sup>1</sup>
18/00-21		10		12 <sup>2</sup>

<sup>1</sup> Intelligence of 18 and wisdom of 19 also required

<sup>2</sup> Intelligence of 19 or wisdom of 19 also required

lose a point of constitution. This loss represents the drying out of the skin, and a maximum of three points of constitution can be lost in this manner. If immersed in water for a minimum of one hour each day, an aquatic elf stays in good physical condition. Lost constitution may be regained by one full day of immersion in water for every point so lost.

Aquatic elves can swim while wearing elfin chain mail, leather, studded leather, or padded armor. Heavier armor causes them to sink to and walk on the sea bottom. Because aquatic elves dislike metal armor, they usually wear armor made from sea creature hides and scales, which can function as padded, leather, studded leather, and scale mail. A few also utilize sea turtle shells for shields quite effectively in combat, but only when out of water. Aquatic elves move underwater at the same rate a land-born character moves outdoors; for example, three times the movement rate in a dungeon.

When fighting underwater, the aquatic elves have no natural penalties to hit as do land dwellers. They also gain automatic

initiative against land dwellers when the two are in combat underneath the water.

The aquatic elven race prefers to live underneath the waves, so they rarely adventure on land. Though they are an amphibian race, they feel out of place on land, as a human would feel if he spent long amounts of time underwater. Aquatic elven clerics worship the deity Deep Sashelas (from *Legends & Lore*, pages 92 and 125). The overall alignment of sea elves is chaotic good, though player characters and NPCs may be of any alignment.

#### Aquatic elf/half-elf

The aquatic elf/half-elf is the offspring of a sea elf and a land elf, usually of the high-elven sort. A character of this race can opt to be of any character class permitted to either parent, but not of a class forbidden to both; the cavalier class cannot be entered. An aquatic elf/half-elf has the ability to see into the infrared spectrum out to 60' in darkness, above or beneath the water. Aquatic elf/half-elves also have a 30% resistance to *sleep* and *charm* spells, and they can detect secret and concealed

doors as well as full-blooded aquatic elves. Being able to breathe underwater as well as aquatic elves, the aquatic elf/half-elf can swim and fight underwater just as well as an aquatic elf can. They have normal chances for surprise above and beneath the water (2 in 6 chance). Starting ages are as per normal elves. These beings do not lose constitution points from staying out of water. Ability score maximums and minimums are as per the *Players Handbook*, page 15 (for elves in general); a +1 comeliness bonus is applied.

Aquatic elf/half-elves speak elvish, and six of the following languages: locathah, merman, sahuagin, triton, gnome, halfling, goblin, hobgoblin, orcish, gnoll, or the "common tongue" of mankind. They can also learn an additional language for every intelligence point that character has above 15; e.g., a character with an 18 intelligence score could learn an additional three languages. Aquatic elf/half-elves can also summon and communicate with dolphins like aquatic elves.

The appearance of this sort of being varies, with the aquatic-elf characteristics being most prominent (gills, silvery skin, and webbed fingers and toes). The eyes and hair usually take the appearance of the land-elf parent.

---

#### Aquatic elf/half-elves

Ability score	Cleric/Druid	Fighter/Ranger	Thief/Thief-Acrobat	Assassin	Magic-user
15	7	6	U	10	10
16	8	6	U	10	10
17	9	6	U	10	10
18	10	7 <sup>1</sup>	U	10	10
18/75		8 <sup>2</sup>		10	
18/90		9 <sup>2</sup>		10	
18/99		10 <sup>3</sup>		11 <sup>5</sup>	
18/00		11 <sup>3</sup>		12 <sup>6</sup>	
19	11	12 <sup>4</sup>	U	12 <sup>6</sup>	11
20	12	12 <sup>4</sup>	U	12 <sup>6</sup>	11
21	12	13 <sup>4</sup>	U	12 <sup>6</sup>	12

<sup>1</sup> Rangers also need intelligence and wisdom of 15

<sup>2</sup> Rangers also need intelligence and wisdom of 16

<sup>3</sup> Rangers also need intelligence and wisdom of 17

<sup>4</sup> Rangers also need intelligence and wisdom of 18

<sup>5</sup> Intelligence of 18 and wisdom of 19 also required

<sup>6</sup> Intelligence of 19 *or* wisdom of 19 also required

---

#### Aquatic half-elves

Ability score	Cleric/Druid	Fighter/Ranger	Thief/Thief-Acrobat	Assassin	Magic-user
15	5	6	U	11	7
16	6	6	U	11	7
17	7	7	U	11	7
18	8	7	U	11	8
18/90		8 <sup>1</sup>			
18/99		9 <sup>1</sup>			
18/00		10 <sup>1</sup>			
19	10	11 <sup>1</sup>	U	11	8
20	12	12 <sup>2</sup>	U	11	8

<sup>1</sup> Intelligence, wisdom, and constitution of 18 required

<sup>2</sup> Intelligence and wisdom must be greater than 18; constitution must be 18

#### Aquatic half-elf

An aquatic half-elf is the offspring of a human and an aquatic elf, one of the rarest part-humans known. A character of this sort can adopt any character class permitted to the usual sort of half-elves, save for the bard, barbarian, cavalier, and illusionist classes (and combinations thereof).

The aquatic half-elves have infravision out to 60' in darkness, above and beneath the water. They can swim and fight underwater just as well as an aquatic elf can, and also have normal chances for surprise above and beneath the water. Detection of secret and concealed doors is as per aquatic elves. Aquatic half-elves may breathe air or water freely. Starting ages are as per other half-elves. Constitution points are not lost from staying out of the water. Ability score maximums and minimums are as per the *Players Handbook*, page 15; a +1 comeliness score is applied.

The aquatic half-elf speaks the following languages: elvish, locathah, merman, sahuagin, triton, and common. The aquatic half-elf can summon and communicate with dolphins like an aquatic elf.

#### Mariners

If the mariner NPC class is employed (*DRAGON*® Magazine #107, page 38), the mariner class may be substituted in the following tables for the fighter class by any given character. However, a dexterity of 17 is required to exceed 10th level as a mariner for any aquatic elf, elf/half-elf, or half-elf. A dexterity of 18 is required to exceed the 12th level. †



Soviet troops are landing in your home town. In this, its darkest hour, America needs heroes. You play the role of an American freedom fighter, desperately struggling to free your country from the crushing burden of Soviet oppression. The fate of America is in your hands.

# THE PRICE

OF FREEDOM

## ROLEPLAYING IN OCCUPIED AMERICA

### Features:

- "Waging Guerrilla War" — how to fight the Soviet occupation; the methods and objectives of the American Resistance.
- Extensive Background Material on how America fell, the organization of Soviet society, and how the Soviets plan to remold America.
- Tables of Organization and Equipment for the American Strategic Direction — the Soviet occupation forces.
- Campaign development — creating a setting, character backgrounds, recurring NPCs, etc.



West End Games, Inc.  
251 West 30th Street  
New York, NY 10001

For 2-6 Players  
and Gamemaster

THE PRICE OF FREEDOM IS \$19.95



# The ecology of the Minotaur

by Anthony Gerard

It was on the fifth of Fishspawn, in the year 425 of the Dancing Unicorn, when my caravan was attacked and taken by a large band of orcs. Amongst this horde were several ogres and minotaurs serving as mercenaries in the pay of the orcish chieftain, Garkun Three-Fingers, who was slain in the following month in the elven lands. After the caravan's defeat, several other unfortunates and I were given over to a large bull minotaur as part of the plunder, and thus began my captivity among the horned ones.

As I, more than any other human I know, have spent more time in the presence of minotaurs, I have taken it upon myself to write this brief narrative of their lives and habits. During my captivity, I observed in detail the society (such as it is) of these bestial folk, and was able to prolong my life by using this information to its best advantage in dealing with my lord and his monstrous people.

## Of their appearance

For the benefit of the masses, I shall here note the obvious. The minotaur is a large, bipedal creature; a manlike beast with a bull's head, hooved feet, human hands, and thick, wiry hair on the head, forearms, lower abdomen, chest, and lower legs. Bull minotaurs often attain nine feet in height; females are generally somewhat shorter, perhaps seven feet on the average, but of no less savage a temperament.

The lower body and torso are similar in general appearance and build to those of ogres, although hairier. Females have breasts and broad hips similar to those of most humanoid types. The minotaur's hands are massive and have thick yellow nails, which occasionally serve as claws, though they often break.

As is common knowledge, the head is bovine in appearance, but there are many differences to the careful observer. The snout is thicker and more drawn out than that of an actual ox. The teeth, particularly the canines, are large and pointed, for minotaurs are carnivores of the most fell sort and regularly bite at their enemies and prey. Occasionally, the canine teeth protrude even when the mouth is closed. The eyes are set more forward and closer together than those of actual cattle, granting minotaurs depth perception.

The head is heavily furred, with the hair color ranging from black to a light red-brown tone. Bodily hair is the same color as the head hair, although somewhat shorter and stiffer. The large, deep eyes are generally a dark brown. The horns of the minotaur are structurally similar to an ox, consisting of a horn sheath over a central bone core. Both sexes possess horns, although those of the male are larger and heavier. The horns normally curve slightly forward, although they may





be broken or bent at an odd angle from old injuries. I have heard that some minotaurs possess the tails of cattle, but those I knew had no tail at all.

The horns of a bull minotaur are his pride. Certain free moments of his leisure time are spent polishing their length with old furs or rags, or sharpening their tips with stones. The color of the horn varies with the color of the hair, although bi-color and tri-color horns are not uncommon. Dark-haired minotaurs generally have dark yellow or yellow-brown horns. The minotaurs I was among seemed to favor darker horns for cultural reasons — and to this end, they oiled and stained their horns to achieve a dark tone. The horns were often decorated in one manner or another, being often studded with decorative brass or silver tacks and spikes. I saw one minotaur whose left horn had apparently been severed by an axe blow; the horn had been rejoined and secured by an etched band of brass, through the artifices of a gray dwarf who served as the band's blacksmith.

Other than horn ornamentation, minotaurs wear little in the way of decorative jewelry. A few of my acquaintance wore studded gauntlets or waistbands, which obviously showed ogriish influence. Minotaurs are hardly above copying a style or mannerism used by other races, since they have so little to contribute on their own save their native barbarism. If a said decoration is seen to enhance one's fearsomeness, every minotaur who sees it will adopt it at the drop of a hoof.

### Of their growth

Minotaurs breed and give birth throughout the year, and their society favors replenishment and increase of their numbers. A single minotaur is usually born to a cow; twins are rare and regarded as holy. By its second year, a young minotaur has fully developed horns and can fight an orc on equal footing. By its fifth year, a minotaur is larger than a man, and by its tenth year, it has attained adult size and mannerisms. Sexual maturity comes early, even by the third year in some, and breeding likewise begins quickly for them. To bear a warrior son is the highest act to which a cow may aspire; to father a great many warriors is merely another social ornament for the male.

Young bulls are tutored in the use of weaponry by their sires and other males. The youths spend much of their time wrestling and fighting among themselves, as rivalry between bulls is fostered virtually from birth. Few cruelties are spared in their battles, and the scars from horn and tooth of one's early battles with other minotaurs serve to strengthen the warlike charisma that the bulls prize so highly.

There is little maternal affection among minotaurs. A young bull shows respect to a female, even its mother, only as long as she is physically superior to him. The world of the minotaur is rooted in brutal-

ity and force of might, and females are barely more than slaves among them.

When he reaches maturity, a young bull may wander widely to avoid contact with older, stronger bulls. Solitary minotaur encounters are usually of this type. My master was fond of boasting about his exploits during this time of his life; he cared little for civilized marvels, being intent upon showing his mastery over the world at large through acts of wanton violence and destruction of the basest kind. No barbarian warlord has known the utterly bestial worship of a minotaur for that which we call wickedness.

The minotaur's lifespan may be as long as eighty years, but because of the violence inherent in their life-styles, few live to even a ghost of this age. My master was a veteran of perhaps thirty winters, past his prime but still one to be feared and reckoned with by anyone of reason.

### Of their society

To speak of minotaur society is perhaps as senseless a remark as to speak of the art of the orcs, yet certain traits become obvious to anyone even crudely familiar with this species. Particular practices vary to extremes between tribes of minotaurs, being snatches of other cultures and beings, adopted by minotaurs for a short time — only to be discarded as soon as a new practice is seen. I witnessed the sudden appearance, spread, and disposal of a hundred practices during my captivity, borrowed from every source within imagination — even from mortal enemies.

Polygamy suits minotaur bulls well; a strong bull may maintain a harem of up to six or seven females. Infanticide is rarely practiced by minotaurs, save for deformed births, despite their desire for more bulls. I have mentioned their concern with constant breeding and increase of their numbers. Even the birth of twin cows (considered an evil portent by some tribes) is better than no births at all. A cow, at least, can take her frustrations out upon the slaves kept either in common or by a particular bull. I have been too well acquainted with this practice myself, though I found ways of avoiding such unwanted attentions from the harem kept by my own master. I dwell more upon the lot of slaves elsewhere.

Bull minotaurs engage each other in combat over plunder, females, positions of authority, and any other possible point of friction that may be imagined. The leader of a raiding party or the dominant bull in an area is always the largest and strongest, but not necessarily the most intelligent. In such combat, the antagonists grapple weaponless, seeking to kick, bite, or gore each other into submission or an early grave. One or both of the opponents in such a duel may end up fatally wounded — which is often what was intended by the victor. A minotaur killing another in combat typically takes the left horn of his victim as a trophy. The tip of the horn is

then removed so that it can be winded in battle or celebration. Such horns are highly prized; my captor owned four.

Slaves are usually supervised by females or young bulls and are employed in enlarging and adding to the labyrinthine minotaur lair. Minotaurs are not especially vigilant in overseeing their slaves. Escapes, at least temporary ones, are commonplace. The chief recreation of bull minotaurs (when not out raiding or drinking) is tracking escapees through the lair or overland. Perhaps one slave in two makes the escape a permanent one; of the one who fails, little can be said, save that perhaps it is better that minotaurs do not share the love of torture that other monstrosities (human and otherwise) relish. I digress, but here I shall note that a minotaur regards death as a holy thing that should come quickly, cleanly, and in combat. If the opponent has no weapons, at least the fight is ended much the sooner, and the victor can enjoy the status of another kill (though it will be of little worth, as they give more honor to kills against powerful and dangerous foes). A minotaur who has slain thirty men or orcs in a battle would not be held in half the respect accorded one who killed an ogre or another minotaur fighting for the opposition.

Minotaur favor twisted mazes in places underground or in dense forests for their lairs. My captor was lord of an area commonly referred to as the "Forest of Thorns," which was reputedly once an elven woodland burned by orcs. In this place, great thorn trees, thick as a man's thigh, grow and intertwine to the the point that they block the very sun. Through this dismal wood, the minotaurs had chopped a great maze of tunnels and chambers, forming a nightmarish dwelling that seemed to have no end.

Yet, this series of passages, hopelessly confusing to a civilized mind, is navigated by the minotaur with surreal ease. I believe this ability is due largely to the minotaur's acute senses (especially the olfactory one), though perhaps an inborn trait is present which allows the minotaur to puzzle out geometry with the skill of the eldest mathematical savant of any university. A minotaur can retrace its own trail through an unknown area with uncanny accuracy, its nostrils flared and snorting at the scent that it leaves — yet I heard of a minotaur called Faceless, which had suffered a severe facial wound that destroyed any sense of smell which it must have had, but was capable of the same feat.

In armed combat, minotaurs favor weapons that kill by concussion — a crude strategy, but one appropriate to their nature. Their favored weapon of choice is by far the two-handed poleaxe. Stoutly functional, these axes are rather crudely made. During my captivity, I never saw any means by which the minotaurs might have produced these themselves; I believe they obtained their weapons in trade from orcs or hobgoblins. Minotaurs also employ

# USE SOME MAGIC



## DRAGONBONE™

Electronic D3, D4, D6, D8, D10, D12, D20, D% Dice Wand

Comes in Charcoal, Bone or Blood Colors

\$24.95 + \$1.00 shipping

PATENTED ONE YEAR GUARANTEE



## DRAGONSKIN™

Protective Book Covers

Textured Charcoal-colored vinyl  
(Fits 11¼" x 8⅞" x ½" Rule Books)

\$3.50 + .50 each shipping



THIEF GOLDEN DRAGON REDHEAD DRAGON



GRIM REAPER SYMBOL OF CHAOS MAGIC USER



FIGHTER UNICORN ILLUSIONIST AMAZON



CLERIC DRUID

To order call:

1-800-228-5287

In Illinois: 312-257-9010

OR MAIL CHECK OR MONEY ORDER TO:

**DBE Inc.**

25 Sunhill Lane  
Lemont, Illinois 60439



ALLOW 4-6 WEEKS FOR DELIVERY

massive two-handed hammers, clubs, or flails. Occasionally, they use stout, thick spears, although only as thrusting weapons; I have never seen a minotaur throw a spear or other weapon, save in frustration.

Minotaurs prefer the company of ogres or other minotaurs. They have a grudging respect for trolls and, one would assume, also for giants. They look down on the human, humanoid, and demi-human races, making little distinction between them, save as individual combatants whom the minotaurs must fight and conquer. True monsters, like dragons, are merely opponents.

Minotaurs are exceptionally fond of alcoholic drink, especially strong "hard" liquors and wines. Three times in the company of visiting ogres, I observed my captor drink himself into a stupor that lasted for several days (as, indeed, his brutish guests did as well).

The language of the minotaur is very similar to that of the ogre. As I was somewhat familiar with ogrish, I was soon able to overcome the differences between the two tongues. Aside from their actual spoken language, there are a few vocalizations common to minotaurs alone. When enraged or excited, a minotaur bellows in a manner reminiscent of an actual bull. When pursuing prey or searching for a hidden enemy, a minotaur gives out a snort every few seconds, in an attempt to acquire possible scents.

The majority of minotaurs worship the demon lord of their kind, Baphomet, to a greater or lesser degree. A Jovite high priest has since told me that he believed them to be a special creation of Geryon from original ogrish stock, but I harbor my doubts. Other creatures mix the natures of two or more basic beasts, such as the centaur and the pegasus, yet we have no sure knowledge of how they came to be so, either. The gods will have their way. I never heard the name Geryon mentioned by any minotaur, though they freely called out the name of their own lord in curses, oaths, and taunts.

Minotaur bull-priests are easily recognized from other minotaurs. Their horns have series of crude pictograms carved into them; these "runes" are then darkened with blood, and the horn is coated with a dull yellow stain so that the carvings stand out in vivid contrast. In addition, the bull-priests have themselves painted with natural stains from earth and plant matter, and splash the blood of slain enemies upon themselves after battle. Gnoll blood is favored for some reason that I cannot explain, though some sage who has other knowledge of these beings may know the answer. Sacrifices are generally conducted in a central chamber of a bull-priest's labyrinth, usually before battle. Humans are the most common sacrifice, as they are the most easily available. It is reputed that if such a sacrifice is especially pleasing to the lord of mino-



taurs, it is consumed by a "cold flame." The passageways leading to such sacrificial chambers are decorated with the bones of previous victims in curious, intricate patterns.

Minotaur bull-priests are given some measure of grudging respect by other minotaurs, but this is always dependent on the physical strength of the priest himself. A battle horn made from a carved bull-priest's horn is highly regarded by minotaurs, so I assume the bull-priests may be slain by their fellows with the same facility as any other minotaur.

Overall, minotaurs are ignorant in the ways of magic. They are not curious, awed, or even amused by the ways of spell casters; magic is either a threat or arrogantly ignored. For this reason, minotaurs may be easily duped by even the simplest of magic, although illusions must be of the most superior sort to trick the minotaurs' keen senses. Minotaurs place no special value on magical items in a treasure hoard, although they may be aware of the items' value to other creatures. Magical items are soon traded for liquor or other prizes (unless the item is a weapon), so a minotaur's hoard rarely contains many such dweomered things.

### Of my escape

For two years and two-hundred seventy-one days, I dwelt amongst these bestial creatures, and I came to know them as well as perhaps any could. I knew their smell, their curses, their triumphs, and their rage. I can close my eyes now and see my old master, doubtless now a mere skeleton on a forgotten battlefield, his offspring raiding and looting with their own savage tribes.

Many slaves were taken by my master's folk, but only I was favored enough to be kept alive, even when food was in short supply and my master's massive frame shrank from starvation. I could not have run from him, having a disabled knee from the day of my capture, and I had no muscles with which to fight him directly — but I was a student of spatial geometry before I took up my father's business and became a merchantman, and my teachers said that my ability at drafting was uncommonly sharp.

Thus, I survived by teaching my master puzzles. From the first, trembling moment when I handed that evil beast-lord a scrap of parchment with a maze drawn thereon, to the next thousand nights that followed, my life was wholly dependent upon my ability to create a fresh, new maze for my master to solve. He could not use his nose to solve it, you see, so only his eyes and brain were of use — truly a challenge for any of his kind. No man can imagine how slender a thread held me from destruction, save for my own terrorized ingenuity at creating brain-teasers, one per night, to keep that bull amused. Though he told me that he would slay me outright if any of

my designs failed to challenge him, I believe that toward the end he came to be rather fond of me, and even kept other minotaurs who would have slain me for my poor meat away from my person at risk of his own life.

Such are the ways of the gods. When the scout force for Lord Darduin's dwarven legions rescued me in the heat of a pitched engagement, I had bettered my own understanding of mathematics to the highest degree, and now spend my days at this university, a teacher and scholar — and a free man.

Perhaps I should be grateful, but surely you understand if I wish it had been otherwise. When the weather changes and my knee aches, I sit and remember those days at my master's hooved feet, and wish I could forget.

### Additional notes

1. Minotaurs are very adept at tracking and trailing. They have a base 50% chance to trail a man-sized creature. This base is modified upward 5% for each additional man-sized creature in a tracked group. The base is modified downward for environmental and terrain factors, or a pursued party's effort to conceal its scent trail (see *Unearthed Arcana*, page 21-22, for possible additional factors). A minotaur has a 20% chance to trail prey without the use of smell, using its other senses alone —

especially its 90' infravision. This base chance is decreased 2% for each melee round elapsed since the creature passed. The base is also modified (at the DM's option) for environmental and terrain factors.

2. Due to its keen senses of smell and hearing, a minotaur has a 20% chance to detect invisible creatures. The base chance is increased upward by 3% for each additional man-sized creature present.

3. A base 75% chance is given for a minotaur to retrace his trail through an unfamiliar area using all senses; without the use of smell, the base drops to 45%.

4. A base 25% chance is given for an individual fluent in ogrish to correctly interpret anything said by a minotaur.

5. Minotaur clerics reach a maximum of 3rd-level clerical ability. Such clerics cannot cast healing spells. At 3rd level, they gain a spell identical to the second-level magic-user spell *strength*.

6. A minotaur's contempt of magic can work to its disadvantage. For example, a minotaur would be loath to retreat from a magic-user — even in the face of major offensive spells such as *fireball*. Its conceit for its ability would force it to withstand the blast.

7. A minotaur, in addition to biting and goring, may kick with one hoof for 2-7 hp damage or may strike out with one nailed fist for 2-5 hp damage per round. †

# PSI WORLD™



## ROLE PLAYING GAME OF PSIONIC POWERS

An exciting new role playing game in which characters use or deal with awesome psionic powers in a near future setting. **PSI WORLD** offers over seventy-five different skills, twenty-five psionic disciplines, and over ninety specific psionic abilities.

The Gamemaster chooses the nature of the near future society, and with the input of the players, selects the style for their campaign. There are two options:

- The Government has attempted to gain dictatorial powers and uses the Psis as scapegoats to distract public attention from the Government's illegal grab for power.
- The Psis are a true threat to democratic rule as they use their powers to gain unfair advantages in business, politics, and all aspects of daily life. Players take the roles of members of the Psi Police to protect the public from this psionic menace

Be a Psi and control awesome powers of the mind! Protect the innocent from those with great powers as a member of the Psi Police! The choice is yours. Seek adventure in this fast paced game of action and excitement in a near future setting. The only limits are your own imagination!



**FANTASY GAMES UNLIMITED**

**PSI WORLD** includes complete and easily understandable rules, the **PSI WORLD ADVENTURE** with introductory adventures to get your campaign started, Gamemaster's Screen, and master character sheet suitable for photocopying. Everything needed to begin your **PSI WORLD** campaign is included in the boxed set. All of this is yours for only \$12.00.

Available from better shops or direct from Fantasy Games Unlimited at P.O. Box 182, Roslyn, New York 11576.  
Please add \$2 for postage and handling. N.Y. residents please add sales tax.

# Readers' Surprise

Where do you go when the clerics are away?



D&D Body Repair Shop  
Stetsonville, WI

Photograph by James A. Gollata

## FORUM

(From page 6)

of disbelief. When I told them that the door knockers said, "What is your name? What is your quest? What is your favorite color?" they responded by saying, "You've got to be kidding; they didn't *really* say that, did they?" and "This is ridiculous."

More recently, I have seen a lot of humor in *Unearthed Arcana*. Many of the magic-user cantrips have "gags" inserted into them; for example, the verbal components of the *wink* cantrip is "twenty-three skidoo," for *firefinger* "the caster speaks a word of power over elemental fire (such as *ron-son*, *zip-po*, or the much revered word, *dun-hill*)," and for *tweak* "the caster speaks a magic phrase (such as *kitchy-kitchy-coo*)." All of these phrases seemed humorous at the time, but I feel that they degrade the game's atmosphere and fail to amuse the reader/gamer. I think that humor is a vital part of the AD&D game (after all, the main goal of gaming is enjoyment), but when one-liners and such are placed in the *gaming material itself*, the humor loses all of its spontaneity and merely becomes silly and/or cheap. I would like to know what others think.

Archie Li  
Westport, CT

I greatly enjoyed Randal Doering's article, "High-tech Hijinks" (DRAGON® Magazine #114) and he deserves Bahamu's ransom for it. For years I've pondered how I could convert light sabres and laser pistols to AD&D games without

unbalancing the world. I know of a DM who ran us through S-3 and S-1, and we disintegrated the 1,000-year old demilich in .5 seconds. In fact, I was about to switch over to STAR FRONTIERS® or GAMMA WORLD® games when this popped up.

However, I think there are some weak spots. Think about *Star Wars*: How many times did Luke Skywalker recharge his Laser rifle? How many times did Hans Solo put in four AA batteries (not included) in the Falcon? None. How many times does Rambo or G.I. Joe put in a new magazine? What happens when your little brother's Go-bots start appearing in your 25mm scale collection? What if you buy Transformer cards and use the complete set in your Monster Card collection? Power cells need more energy implanted in each one. How about 100 charges in the form of a 12-ounce can? (A six-pack could be used for larger, more energy-needing machines.)

Chris Sanyk  
Cleveland, OH

Having recently acquired the *Dungeoneer's Survival Guide*, I was most impressed with this very good (if somewhat specialized) tome. Mr. Douglas Niles has given us a considerable amount of information that will surely become invaluable during adventures both above and below ground. Of particular interest to me was the section on nonweapon proficiencies; this section helps explain that ancient question, "What did this character do before he became an adventurer?" The only thing which bothered me about this section was the lack of any modifiers for demi-humans.

A starting human character can be, depending on class, anywhere from 16-36 years of age,

while a beginning demi-human character can be, depending on race and class, anywhere from 23 to 600 years of age. That is quite a spread, and the system should take into account the great disparity between human and demi-human ages. For example, a human and a dwarf fighter both start out as 1st-level characters at their respective minimum ages. At 16 years of age, the human has acquired two nonweapon proficiency slots, yet the 45-year-old dwarf has also managed to gain only two nonweapon proficiency slots. What was he doing during those extra 29 years?

Any debate over realism on this subject would be ludicrous (any marginally competent elf of 1,500 or so years could be a master of every nonweapon proficiency in the book); however, I feel that some sort of bonus should apply to demi-humans in this regard.

What I suggest is that all beginning demi-human characters be given a small number of bonus slots for nonweapon proficiencies, since they were acquired before the character became an adventurer.

James A. Yates  
Rockwood, MI

I have just recently began playing an illusionist and am quite confused. The powers which they possess are quite different from those which magic-users possess, and both the DM that I play with and I are confused on how illusions work. We have both gone over the spells of the illusionists and through the *DMG* and have found no helpful information. The information in the *Player's Handbook* is vague and doesn't fully explain how an illusionary spell works.

(Continued on page 56)





# GAMMA WORLD®

GAME HEADQUARTERS

TO: MICHAEL DOBSON, DIRECTOR OF GAMES DEVELOPMENT  
FROM: HAROLD JOHNSON, PROJECT COORDINATOR  
RE: GAMMA WORLD® RULES SUPPLEMENT

Writing to tell you that the 3rd Edition of the all new GAMMA WORLD® game has finally gone to the printer! However, in an attempt to produce the most comprehensive science fantasy role playing game of all time, we greatly overwrote the rules. Due to scheduling constraints and price considerations, we had to leave out a lot of this material.

What we have is a lot of additional material that there was literally no room for in the product! Sure we could wait to present this material in later product, but not all references to these sections were deleted from the rules and this will cause some confusion. We have a hot idea to propose, which will capture the public's attention and take advantage of the game's debut. Why wait a year to complete the game, let's give it to the public now! Here's what we propose.

- Release a GAMMA WORLD® game supplement for FREE!
- All a customer needs to do is mail a postcard with their name and address to:

GAMMA WORLD® Supplement  
The Mail Order Hobby Shop  
P.O. Box 756  
Lake Geneva, WI 53147

- We can use this chance to get one step ahead of the game by using this opportunity to correct the inevitable errata we discovered at the start.

Everyone here is really excited about this edition. The product plans are great and are already completed! The mysteries of the Ancients and the unknown Tech V devices should tantalize the players, not to mention the great goal of reaching the legendary Cities of Man. And once the great saga of the Sky Chariot is solved, Project Omega will really blow their doors off!

This booklet would be in addition to our current plans to launch the great saga to build a Sky Chariot, which begins with GW6 - Alpha Factor, and the discovery of the memory core of the world's greatest computer at Mindkeep.

With what they gain here, the saga continues on through:

- GW7 - Beta Principle, a quest for the spacecraft's hull.
- GW8 - Gamma Base, an active military complex of the Ancients, a perfect place to assemble the great ship.
- GW9 - Delta Fragment, an adventure to recover the knowledge needed to fly the great ship and beyond.

This product will also feature the first rules expansion, including new artifacts, creatures, and advanced rules for skill specialization; as well as the first inkling of the power of the mysterious crystalline technology.

And this is just the tip of the iceberg! All leading to the climax with Project: Omega!

All this will be followed by support articles and other rules expansions in the pages of DRAGON® Magazine and the POLYHEDRON® Newsletter of the RPGA® Network. All those fans who wrote us demanding the game's return, will look to their favorite gaming magazine for more support and coverage of their game!

Consider producing this surprise supplement. It can only earn us good will from the gaming public.

-HJ

Harold - Radical idea!  
Go for it! (but the  
expense is coming out of  
your paycheck).  
Michael

---

# THE DRAGON'S BESTIARY

The Dragon's Bestiary last graced the pages of DRAGON® Magazine in issue #61. Since then, new monsters have made only occasional appearances here (save in our Creature Catalogs) — but that has now changed. We are pleased to bring back one of the most-liked of our columns, hopefully for a long stay.

This edition of The Dragon's Bestiary presents new flora and fauna for oceanic adventuring. Handle them with care — if you handle these creatures at all.

## Credits

Gregg Chamberlain: *Brain coral, giant clam, giant grouper, giant porcupine fish, electric ray, sawfish/sawshark*

Alex Gray: *Sea titan*

Spike Y. Jones: *Sea centaur, weed giant*

Nick Kopsinis: *Giant sea anemone*

Robert Maurus: *Morana*

---

## BRAIN CORAL

FREQUENCY: *Very rare*

NO. APPEARING: 1

ARMOR CLASS: 10/5 (*exoskeleton*)

MOVE: *Nil*

HIT DICE: 3

% IN LAIR: 100%

TREASURE TYPE: *Incidental*

NO. OF ATTACKS: *See below*

DAMAGE/ATTACK: *See below*

SPECIAL ATTACKS: *Poison, psionic powers*

SPECIAL DEFENSES: *Psionic powers*

MAGIC RESISTANCE: *Standard*

INTELLIGENCE: *Exceptional*

ALIGNMENT: *Neutral*

SIZE: *S (2')*

PSIONIC ABILITY: *60-100*

Attack/Defense Modes: *See below*

LEVEL/X.P. VALUE: *III/120 + 3/hp*

Brain coral is an evolutionary offshoot of a type of stony coral. It has an exoskeleton that is convoluted and ridged so that it resembles a human brain. Like its simpler cousin, this more advanced type of brain coral is restricted to the warm waters of the tidal zone, but may be found at depths of 1,000' + . Usually, it is found with the growth of a coral reef or atoll where feeding is easier.

The brain coral consists of the animal polyp which has settled and, over the years, built up an exoskeleton of pure calcium carbonate around it for protection. The exoskeleton is AC 5 and takes damage equal to the total hit points of the

attack/defense modes randomly determined as for player characters. It has 2-5 minor disciplines and a 25% chance of having a major discipline. The minor disciplines are among the following: *animal telepathy, cell adjustment (as fighter), domination, ESP, invisibility, and clairvoyance*. The major discipline is *telekinesis*, which is always accompanied by *clairvoyance* as a minor discipline. All powers are at the ninth level of mastery.

If encountered, a brain coral may attempt to read its visitors' minds if the coral has *ESP*. If attacked and if it possesses *telekinesis*, the brain coral uses its power either to move attackers away from the area or to batter one attacker with underwater debris for 2-5 hp damage/round.

polyp before fracturing enough to allow the attacker to actually get at the AC 10 polyp. Nematocysts (stinging cells) throughout the skeleton inject a weak neurotoxin into victims which can paralyze for 1-10 rounds (save vs. poison at +4).

The brain coral has a psionic strength of 30-50 points (60-100 psionic ability) with



Brain coral skeletons are yellow, brown, or olive in color. If removed from the water, the skeleton turns bone white.

---

## CENTAUR, SEA

FREQUENCY: *Very rare*  
NO. APPEARING: 1-3  
ARMOR CLASS: 5  
MOVE: //24"  
HIT DICE: 5  
% IN LAIR: *Nil*  
TREASURE TYPE: *See below*  
NO. OF ATTACKS: 1 *weapon*  
DAMAGE/ATTACK: *By weapon type*  
SPECIAL ATTACKS: *Spells*  
SPECIAL DEFENSES: *Spells*  
MAGIC RESISTANCE: 5%  
INTELLIGENCE: *Average to exceptional*  
ALIGNMENT: *Chaotic good*  
SIZE: *L (12-15' long)*  
PSIONIC ABILITY: *Nil*  
Attack/Defense Modes: *Nil*  
LEVEL/X.P. VALUE: *V/245 + 5/hp*

These aquatic creatures appear to be a cross between a triton and a hippocam-

pus. They are found in any area where either of the other two creatures might be found.

Sea centaurs usually gather in small, nomadic families, but occasionally may be found amongst a group of tritons. Tritons feel superior to the sea centaurs because of the latter's lesser abilities (e.g., lower magic resistance, lack of psionic ability, etc.); tritons sometimes use sea centaurs as mounts if the latter are agreeable.

For the most part, sea centaurs have no treasure (except for an occasional piece of jewelry), although 10% of them have acquired tritons' magic conch shells. When used by sea centaurs, these shells summon 2-8 hippocampi; they can also be used to send messages underwater within a half-mile radius.

There is a 10% chance that any sea centaur has the ability to cast spells as a 1st-4th level druid. All sea centaurs speak triton and hippocampus, and 25% of them also speak common. They say little about the deity they worship, but it is assumed to be the same one as worshiped by the tritons (i.e., Triton).

and hold prey with a strength greater than 6.

The carnivorous clam can, by a sudden expulsion of water through closing its shell, jet backwards and ram an opponent within 5' for 1-10 points of damage. The clam's usual method of attack is to shoot a mild neurotoxin into the water through its exhalant siphon. The toxin disperses in a 5'-diameter cloud and causes paralysis for 1-12 rounds to any creature that fails to make its saving throw vs. poison. The paralyzed prey is then grasped by the clam's tentacles and either pulled directly into the clam (for 1 hp/turn digestion damage thereafter) or cut into smaller pieces by sawing motions of the clam's shell (1-2 hp damage/round).

The inside of both clam shells are lined with nacre or mother-of-pearl, with a base value of 50 gp depending on the amount of mother-of-pearl adventurers can recover. (DMs should consult the table on page 26 of the *Dungeon Masters Guide* to determine the final amount. This amount should never exceed 500 gp.) There is a 10% chance that a clam has one giant pearl worth 500-1000 gp, depending upon its size and quality. The pearl may be as large as a fist, but will not be as lustrous as smaller pearls from pearl oysters. There is a 5% chance that, scattered about or buried in the sediment around the clam, a few coins, accoutrements, or minor magic items were left behind by an unfortunate victim who was caught and drowned.

Both clams are nearly identical in appearance. The upper shell of both clams is light brown, while the lower shell is white. Giant clams of both varieties are found nestled in the sand or resting on the sedimentary bottom of oceans. Sometimes, the giant clam buries itself to provide an offensive advantage against prey (surprise on 1-5).

---

## CLAM, GIANT

FREQUENCY:	Giant Clam <i>Rare</i>
NO. APPEARING:	<i>1-4</i>
ARMOR CLASS:	<i>10/3 (shell)</i>
MOVE:	<i>//1"</i>
HIT DICE:	<i>3</i>
% IN LAIR:	<i>100%</i>
TREASURE TYPE:	<i>See below</i>
NO. OF ATTACKS:	<i>Nil</i>
DAMAGE/ATTACK:	<i>Nil</i>
SPECIAL ATTACKS:	<i>Entrapment</i>
SPECIAL DEFENSES:	<i>Nil</i>
MAGIC RESISTANCE:	<i>Standard</i>
INTELLIGENCE:	<i>Non-</i>
ALIGNMENT:	<i>Neutral</i>
SIZE:	<i>M (6' length)</i>
PSIONIC ABILITY:	<i>Nil</i>
Attack/Defense Modes:	<i>Nil</i>
LEVEL/X.P. VALUE:	<i>III/90 + 3/hp</i>

Both the giant clam and the giant carnivorous clam are found in shallow tropical and semitropical waters, down to a maximum depth of 200'. Both have numerous tiny, blue eye spots located near the edges of the shell. These eye spots can distinguish between light and shadow, and can detect movement, but not size. Special organs near the front of the mantle cavity, where the soft body of the clam sits, detect and analyze chemical traces in the water.

The giant clam is a filtrationist, living on minute shrimp and microscopic animals, and on algae colonies growing inside the clam's shell mantle. When threatened or when something reaches inside the clam's shell, the giant clam's usual defense is to close its shell. Due to the animal's power-

FREQUENCY:	Giant Carnivorous Clam <i>Rare</i>
NO. APPEARING:	<i>1-4</i>
ARMOR CLASS:	<i>10/4 (shell)</i>
MOVE:	<i>//1" [10" using bursts]</i>
HIT DICE:	<i>4</i>
% IN LAIR:	<i>50%</i>
TREASURE TYPE:	<i>See below</i>
NO. OF ATTACKS:	<i>1 ram</i>
DAMAGE/ATTACK:	<i>1-10</i>
SPECIAL ATTACKS:	<i>Poison cloud, surprise, continuous damage</i>
SPECIAL DEFENSES:	<i>Nil</i>
MAGIC RESISTANCE:	<i>Standard</i>
INTELLIGENCE:	<i>Animal</i>
ALIGNMENT:	<i>Neutral</i>
SIZE:	<i>M (6' length)</i>
PSIONIC ABILITY:	<i>Nil</i>
Attack/Defense Modes:	<i>Nil</i>
LEVEL/X.P. VALUE:	<i>IV/175 + 4/hp</i>

ful adductor muscles, which act as a hinge for the shell, a *bend bars/lift gates* roll is required to force the shell open again.

The giant carnivorous clam has evolved a slightly higher intelligence than its sessile cousin, which it uses to hunt for prey. Both clams are capable of using their inhalant and exhalant siphons to move across the sea bottom; the carnivorous clam can also, through vigorous clapping of its shell halves, "swim" in a jerky fashion with its exhalant siphon, providing lateral adjustment and maneuverability. The shell thickness of the clam is reduced to increase buoyancy. The clam's external cilia have evolved into a set of 4-10 2'-long tentacles, used mainly to grasp and move prey to the clam's stomach. The tentacles are too weak to do any damage or to grasp

---

## GROUPEY, GIANT

FREQUENCY:	<i>Uncommon</i>
NO. APPEARING:	<i>1-6</i>
ARMOR CLASS:	<i>5</i>
MOVE:	<i>//20"</i>
HIT DICE:	<i>5</i>
% IN LAIR:	<i>75%</i>
TREASURE TYPE:	<i>R, X</i>
NO. OF ATTACKS:	<i>1 bite</i>
DAMAGE/ATTACK:	<i>2-12</i>
SPECIAL ATTACKS:	<i>Swallow whole, continuous damage</i>
SPECIAL DEFENSES:	<i>Nil</i>
MAGIC RESISTANCE:	<i>Standard</i>
INTELLIGENCE:	<i>Non-</i>
ALIGNMENT:	<i>Neutral</i>
SIZE:	<i>L (17'-20')</i>
PSIONIC ABILITY:	<i>Nil</i>
Attack/Defense Modes:	<i>Nil</i>
LEVEL/X.P. VALUE:	<i>IV/205 + 5/hp</i>

The largest of the grouper family of fish, the giant grouper weighs as much as 1,000



pounds. A deep sea predator, the giant grouper can usually be found lurking near coral reefs or lairing in the sunken hulls of wrecked ships. Its huge jaws act in a manner similar to that of a suction pump, drawing smaller fish into the gaping maw of the grouper. Solitary divers sometimes fall prey to this fish.

The grouper can, on a natural die roll of 20, swallow a man-sized or smaller object whole. If a swallowed person swallowed has a dagger or similar small sharp-edged weapon in hand when swallowed, he may cut his way out of the fish by inflicting damage equal to 25% of the total hit points of the fish. A character has only 1 turn in which to do this, as the giant grouper's digestive fluids then begin to act, delivering 1-4 hp/round thereafter. Characters may try to exit the grouper when it opens its mouth to swallow other prey as well.

---

## MORANA

FREQUENCY: *Uncommon*  
 NO. APPEARING: 1-4  
 ARMOR CLASS: 6 (2 if moving)  
 MOVE: //18"  
 HIT DICE: 3 + 2  
 % IN LAIR: 30%  
 TREASURE TYPE: *Nil*  
 NO. OF ATTACKS: 1 bite  
 DAMAGE/ATTACK: 3-6  
 SPECIAL ATTACKS: *Surprise, continuous damage*  
 SPECIAL DEFENSES: *Evades missiles, regeneration*  
 MAGIC RESISTANCE: *Standard*  
 INTELLIGENCE: *Animal*  
 ALIGNMENT: *Neutral*  
 SIZE: *S (3-4' long)*  
 PSIONIC ABILITY: *Nil*  
 Attack/Defense Modes: *Nil*  
 LEVEL/X.P. VALUE: *IV/160 + 4/1hp*

The morana is similar to a moray eel in shape, having the temperament of an angry piranha. Moranas are usually gray green, but may be found in lighter or

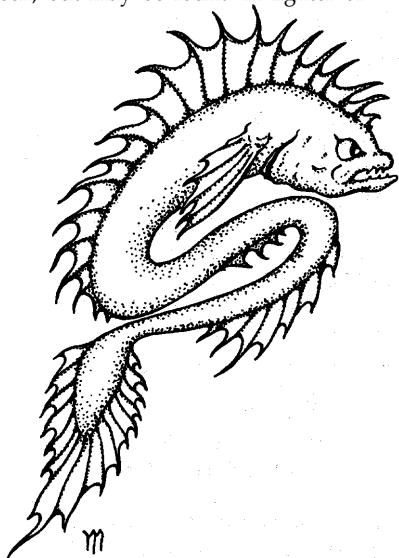

darker colors, usually blending with the aquatic environment. The morana regenerates at the rate of 1 hp/turn if wounded.

The morana's movement is a quick, constant, side-to-side pattern. Missile fire automatically misses the creature at first, and a -4 penalty applies to all such "to hit" rolls thereafter. The morana has AC 3 while in motion. Though the damage from a bite is but 2-5 hp, the morana inflicts additional damage by locking its jaws; the victim of such a bite takes double damage

---

## PORCUPINE FISH, GIANT

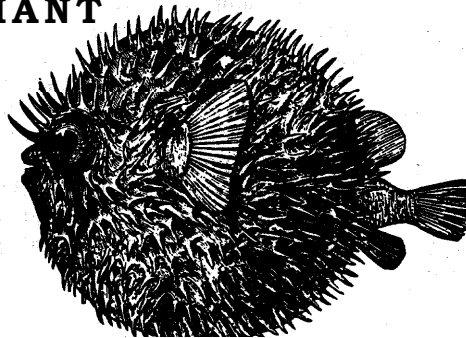

FREQUENCY: *Rare*  
 NO. APPEARING: 1-2  
 ARMOR CLASS: 6  
 MOVE: //25"  
 HIT DICE: 1  
 % IN LAIR: 25%  
 TREASURE TYPE: *Nil*  
 NO. OF ATTACKS: 1 bite  
 DAMAGE/ATTACK: 1-3  
 SPECIAL ATTACKS: *Killing poison*  
 SPECIAL DEFENSES: *Nil*  
 MAGIC RESISTANCE: *Standard*  
 INTELLIGENCE: *Non-*  
 ALIGNMENT: *Neutral*  
 SIZE: *S (2-3' long)*  
 PSIONIC ABILITY: *Nil*  
 Attack/Defense Modes: *Nil*  
 LEVEL/X.P. VALUE: *II/45 + 1/1hp*

The giant porcupine fish is related to the puffer fish and the smaller porcupine fish. The giant porcupine fish is territorial and is most often found near rocky shelters and coral reefs. If endangered, this creature flees to its abode at the earliest opportunity.

The giant porcupine fish can bite for 1-3 hp damage; when attacked or threatened, it inflates its body, swelling to a size three times its normal girth. This action is performed by retaining water in the creature's stomach and using flexible abdominal sacs. By inflating itself, the fish causes numerous dagger-length spines to appear across its body. If an attacker comes within 5' of these spines, the giant porcupine fish may approach and attempt to score a successful hit; if this happens, the attacker takes 3-12 hp damage from the spines and must also make a save vs. poison; failure results in death within 1-4 rounds. In any event, damage is taken, even if the attacker saves vs. poison.

each round following. While locked onto a victim, the creature has AC 6. The morana releases its hold and flees if it is reduced to a third of its hit points or less.

Moranas are aggressive and are avoided even by sharks. They lair in coral niches or caves, much like moray eels, and are often mistaken for morays while resting. If encountered in its lair, a morana may shoot out to 40' in a single thrust, thus gaining a +2 bonus on its "to hit" roll and surprising on a 1-5.

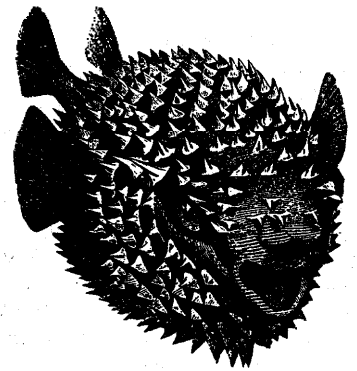



---

## RAY, ELECTRIC

FREQUENCY: *Rare*  
 NO. APPEARING: 1-3  
 ARMOR CLASS: 7  
 MOVE: //9"  
 HIT DICE: 2 + 4  
 % IN LAIR: *Nil*  
 TREASURE TYPE: *Nil*  
 NO. OF ATTACKS: *Nil*  
 DAMAGE/ATTACK: *Nil*  
 SPECIAL ATTACKS: *Electric shock, surprise on 1-5*  
 SPECIAL DEFENSES: *Camouflage (treat as invisible if buried)*  
 MAGIC RESISTANCE: *Standard*  
 INTELLIGENCE: *Non-*  
 ALIGNMENT: *Neutral*  
 SIZE: *M (6' long)*  
 PSIONIC ABILITY: *Nil*  
 Attack/Defense Modes: *Nil*  
 LEVEL/X.P. VALUE: *III/120 + 3/1hp*

Also known as the crampfish and as the torpedo ray on some planes of the multiverse, this member of the family of skates and rays is generally found at depths of 200' in warmer ocean waters, though the creature has been encountered at wading distance from shore. The slow swimming speed for a marine animal of its size is due to the muscles at the base of the pectoral fins — fins which have evolved to form organic plates with a negatively charged underside and a positively charged upper-side. The ray generally makes use of protective camouflage and burrows into the sediment on the ocean floor to avoid its enemies, becoming effectively invisible.

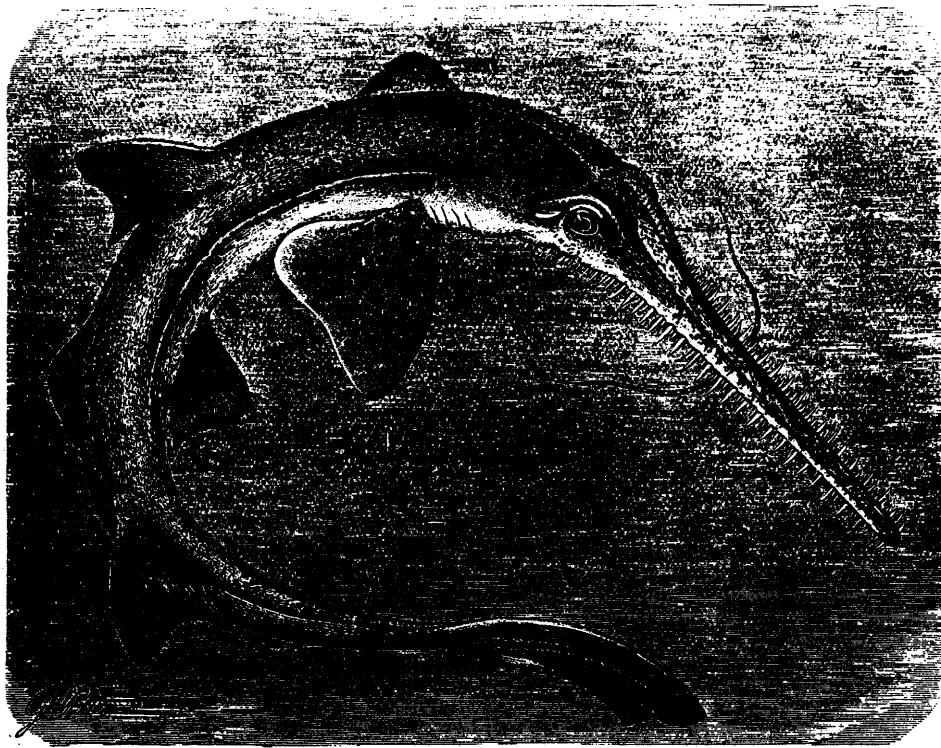
The ray uses its electrical shock to stun or kill the smaller fish upon which it feeds. However, when threatened by larger



predators, the ray releases all its stored electrical energy in one massive jolt (approximately 200 volts) which stuns any creature within a 15' radius. Failure to make a save vs. paralyzation results in a stun which lasts from 2-8 rounds. Regardless of saving throws, the following dam-

age is taken on a shock: those creatures within 5' of the electric ray take 2-12 hp damage, those within 10' take 1-6 points, and those within 15' take 1-3 points. Any creature outside the 15' radius feels a slight tingle, but is otherwise unaffected. The ray itself needs 5-20 rounds to re-

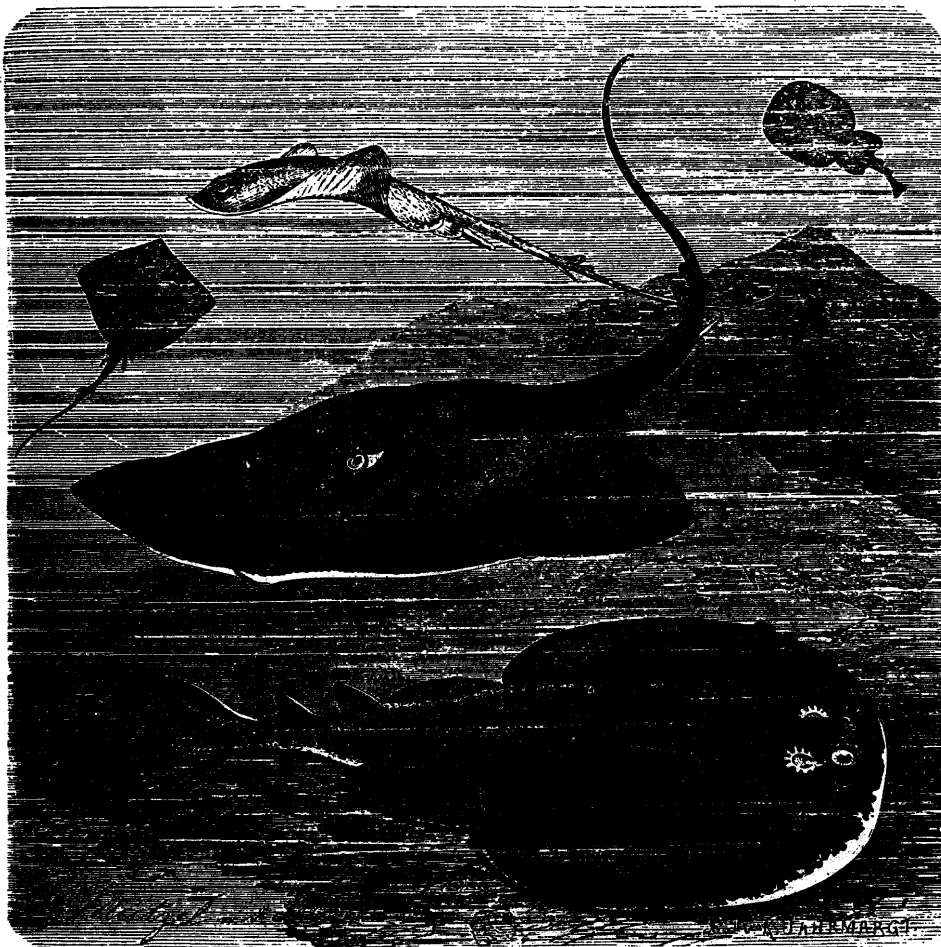

charge itself, and flees until it can do so. An electric ray can use its shock five times a day.

## SAWFISH/SAWSHARK

FREQUENCY: *Uncommon*  
 NO. APPEARING: 2-8  
 ARMOR CLASS: 6  
 MOVE: //20"  
 HIT DICE: 3  
 % IN LAIR: *Nil*  
 TREASURE TYPE: *Nil*  
 NO. OF ATTACKS: 1 slash  
 DAMAGE/ATTACK: 2-8  
 SPECIAL ATTACKS: *Nil*  
 SPECIAL DEFENSES: *Nil*  
 MAGIC RESISTANCE: *Standard*  
 INTELLIGENCE: *Non-*  
 ALIGNMENT: *Neutral*  
 SIZE: L (10- 12' long)  
 PSIONIC ABILITY: *Nil*  
 Attack/Defense Modes: *Nil*  
 LEVEL/X.P. VALUE: II/35+ 3/hp

There is little to distinguish the sawfish from the sawshark except for the position of the gill slits on each fish. On the sawshark, the gill slits are on the sides of the neck; on the sawfish, the gills are on the underside of the body.

The sawfish belongs to the family of rays, and is similar in some ways to the manta and stingray. The sawshark, however, is a true shark. Both the sawfish and sawshark are characterized by a long, flat snout with a row of teeth on each side. Both fish use a side-to-side slashing motion to attack their prey and to defend themselves. This sawlike snout makes up roughly half the total body length of each fish. On some individual fish, the snout itself may be 6' long.

## SEA ANEMONE, GIANT

FREQUENCY: *Rare*  
 NO. APPEARING: 1 or 50-200  
 ARMOR CLASS: 10  
 MOVE: //1"  
 HIT DICE: 7  
 % IN LAIR: 98%  
 TREASURE TYPE: *Incidental*  
 NO. OF ATTACKS: 1-3 tentacles  
 DAMAGE/ATTACK: 1-3  
 SPECIAL ATTACKS: *Paralytic poison, entrapment, swallow prey whole, continuous damage*  
 SPECIAL DEFENSES: *Nil*  
 MAGIC RESISTANCE: *Standard*  
 INTELLIGENCE: *Non-*  
 ALIGNMENT: *Neutral*  
 SIZE: L (see below)  
 PSIONIC ABILITY: *Nil*  
 Attack/Defense Modes: *Nil*  
 LEVEL/X.P. VALUE: VI/875 + 8/hp

The giant sea anemone is essentially a larger and far more dangerous version of

its smaller relative. The larger of the two creatures lives in a variety of ocean depths; At depths greater than 50', however, the giant sea anemone is encountered singly. In tidal pools and secluded shorelines, smaller varieties live in colonies numbering from 50-200.

The giant sea anemone has a maximum tentacle reach of 30'. The body of this creature is roughly 8' in diameter; its mouth is nearly 6' across and is centered between the creature's tentacles. Most creatures of this species have 100 tentacles, with a rare few having more or less than this amount.

A successful hit with a tentacle causes thousands of small, hooklike needles to spring forth from the appendage. The needles as a whole (not each individually) cause 1-3 hp damage on the initial strike. In this manner, the giant sea anemone attempts to restrain its victim, trapping it within the grasp of several tentacles. On the round following a successful tentacle hit, the sea anemone begins secreting its poison into the victim's body. The poison secreted causes a loss of 1 point/round from the character's strength and dexterity scores; similarly, the victim's movement base is slowed by 1"/round. A character reduced to 0 in either strength, dexterity, or movement suffers the effects of paralysis and is unable to move without outside assistance. A save vs. poison negates the effect of this secretion, as does a *neutralize poison* spell or power.

At the beginning of each round, a trapped victim may attempt to break free of the giant sea anemone's grasp. To do so, the character must roll successfully on his *open doors* ability. If the character is held by more than one tentacle, a successive number of rolls equal to the number of tentacles holding the character must be made. Failure to make any of these rolls means that the character has not broken the grasp and is still within the giant sea anemone's grasp. The sea anemone can grasp a character with no more than three tentacles at a time. Once the giant sea anemone has wrapped three tentacles around the character (an action requiring three successful "to hit" rolls), the creature



attempts to swallow the victim whole. A successful "to hit" roll by the creature at this point results in the victim being swallowed. A swallowed victim is ground up by internal organs which do as many points damage per round as the victim's armor class (so AC 0 victims take no damage).

The giant sea anemone cannot be killed by cutting off its tentacles; the central body itself (where the hit points are) must be attacked. A severed tentacle grows back at a rate of 1'/day. The base of this creature cannot regenerate if destroyed (i.e., taken to 0 hp or less). Although the giant sea anemone has the ability to move, most rarely do so, preferring instead to remain in one spot for the duration of their lives. The tidal anemone fastens itself to a rock, while its deep-water cousin sits freely on the ocean bottom or on a rocky ledge. Any treasure left around the giant sea anemone's lair is simply incidental; it is the remaining accoutrements of previous victims.

## TITAN, SEA

FREQUENCY: *Very rare*

NO. APPEARING: 1

ARMOR CLASS: 4

MOVE: //21"

HIT DICE: 22-28

% IN LAIR: 20%

TREASURE TYPE: A, U, Z

NO. OF ATTACKS: 1 punch or 1 flipper slap

DAMAGE/ATTACK: 10-60 or 10-40

SPECIAL ATTACKS: *Crushing hug, spells*

SPECIAL DEFENSES: *Spells*

MAGIC RESISTANCE: 50%

INTELLIGENCE: *High and up*

ALIGNMENT: *Neutral (25% evil)*

SIZE: L (40'+ 2'/HD beyond 22)

PSIONIC ABILITY: *Nil*

Attack/Defense Modes: *Nil*

LEVEL/X.P. VALUE: X/16,600 + 35/1hp

These monstrous beings inhabit the deepest, darkest depths of the ocean, although they sometimes swim to lesser depths to hunt for whales or passing ships. Occasionally, a hungry sea titan ventures into coastal waters. In appearance, sea titans resemble tritons — the main difference being their size. The lower body of a sea titan resembles a scaled pair of fish tails in place of legs (with the fins upright, not flat like a whale's), with the upper body of a man. The sea titan has a ridge of small fins along its spine which extend down the creature's back and legs, diminishing before the flippers. The sea titan's fingers are webbed, and they have blue to blue-green hair, silvery upper body skin, and blue-silver scales.

Sea titans have the ability to summon and control creatures of the sea through

## Elysian Field<sup>tm</sup> mapping accessories

for role-playing and military simulation games

See our brand-new line of Backpack Boards and flexible overlays.

call or write:

**Britton Designs**

5131 S. Blackstone Ave., Chicago, Ill. 60615 (312)493-5852

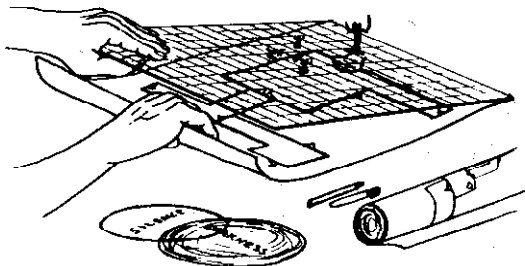



# THE PALLADIUM ROLE-PLAYING FANTASY SERIES!



Palladium Books  
5926 Lonyo  
Detroit, MI 48210

## THE PALLADIUM ROLE-PLAYING GAME®

"First-class magical character classes." Quote from a review in  
Ken Rolston — DRAGON® Magazine

"Very refreshing . . . shows ingenuity . . ."

Knights of Windson

"... the best game on the market . . ."

Dragon Door (fanzine)

"... the stuff that RPGs should be made of!"

Arshia Asudeh (gamer)

The Palladium Role-Playing Game® is a massive 274 page rule book complete with detailed descriptions, weapons, armour, magic, monsters, history, skills, an introductory adventure and fabulous artwork to create a truly beguiling world of fantasy and magic. This is the ONLY book you need to play the game!

### Highlights Include . . .

- 13 Different playing races including Wolfen and Changeling.
- 19 Occupational character classes.
- Quick, playable combat system.
- Men of arms with real punch.
- A unique new approach to alignments and experience points.
- A magic system unlike any before it with 290 magic spells, 60 wards, 50 circles, psionics, wizards, summoners, diabolists, mind mages, witches and warlocks.
- Skills and abilities.
- Dragons, devils, demons, faerie folk and more!!!
- Written and illustrated by Kevin Siembieda.
- \$19.95 (post paid)

## THE PALLADIUM RPG BOOK II: THE OLD ONES

Book II plunges players into a world of magic and danger which ultimately leads to a battle for the salvation of all human life against the minions of the demonic Old One. Adventures of varying length lead players through wilderness, towns and dungeons. Furthermore, the entire Timiro Kingdom is layed before your finger tips. Each city, town and fort is mapped and described with notes on its rulers, villains, merchants and attitudes.

Rule additions include campaign notes and tips, the illusionist and monk as optional character classes, and encounter tables.

### Highlights Include . . .

- 56 Maps
- 34 Towns and Cities; 21 Forts
- New character classes
- Several adventures
- \$14.95 (post paid)

## THE PALLADIUM RPG BOOK III: ADVENTURES ON THE HIGH SEAS A Note From the Publisher:

Regrettably, Palladium RPG Book III has been delayed again! In the designer's own words . . . "Book III is a project that is too important to rush. It is really the first comprehensive addition to the original Palladium RPG rules, with: new skills, eight new character classes, magic, magic items, curses, more on wizardary/circles/symbols, ships, ship to ship combat and island adventures. Other deadlines make it impossible to give Book III the attention it demands. Rather than short change our gamers with an inferior product, I have opted to delay its release. Disappointing? Yes; but I do believe that the finished Book III will knock your socks off." Watch for it early next year.

## THE PALLADIUM BOOK OF MONSTERS & ANIMALS

Monsters and Animals is a source book for the Palladium Role-Playing Game® that provides NEW information about the mysterious Palladium world and its fearsome inhabitants (many of which can be playing characters).

A 60 page animal section provides game stats for more conventional wildlife, such as the wolf and weasel to poisonous snakes and deadly predators. Easily adapted to other game systems.

### Highlights Include . . .

- 90 Monsters
- Over 150 animals.
- Collaborating maps with every creature.
- Written and illustrated by Kevin Siembieda.
- \$14.95 (post paid)

### Complete 1986 Catalog

Send 50¢ for postage and handling to receive the complete catalog of our other fantasy, superhero, and science fiction role-playing games and supplements.

*charm monsters* spell use (by touch, usable five times per day). Sea titans have the additional ability to use as many first- to third-level spells as a 6th-level magic-user (but at the 12th level of ability).

Sea titans feed on larger sea creatures and occasionally on passing sailors. For the most part, however, sea titans do not approach or harass seafarers unless harassed themselves, unless they are evil. An attack on a sea-going ship is performed in one of several ways. The sea titan might batter the ship with its massive arms, capsize the ship by coming up from be-

neath it, or slap it with a flipper. If the ship is small enough, the sea titan may try to crush it by embracing it in its sinewy arms. A punch from a sea titan delivers 4 points of structural (hull) damage per hit; a flipper slap delivers 2 points. A crush delivers 8 points of structural damage. Sea titans have titan strength (a rating of 25).

Though they have little use for magical items, sea titans do have an interest in treasure and often have a sizable stockpile of gold and silver as a result. Sea titans speak their own language, as well as triton and 2-8 other oceanic tongues.

## UNDINE

FREQUENCY: *Very rare (uncommon on Elemental Plane of Water)*

NO. APPEARING: 2-20

ARMOR CLASS: 6

MOVE: //12"

HIT DICE: 2

% IN LAIR: 80%

TREASURE TYPE: P, R, any two magic items (20%)

NO. OF ATTACKS: See below

DAMAGE/ATTACK: See below

SPECIAL ATTACKS: Rapid drowning, paralysis

SPECIAL DEFENSES: Invisible in water, plane shift

MAGIC RESISTANCE: Standard

INTELLIGENCE: Low

ALIGNMENT: Neutral evil

SIZE: S(3' long)

PSIONIC ABILITY: Nil

Attack/Defense Modes: Nil

LEVEL/X.P. VALUE: IV/163 + 2/hp

These creatures come from the Elemental Plane of Water. Like water weirds, they enjoy drowning their victims; it is also believed that they survive by draining the life force of their victims. In appearance, undines are similar to miniature merwomen; they have a single, scaled, lateral tail (much like that of a dolphin) which is connected to a humanoid upper body. Their lairs are simply areas of water which they use as a base for traveling between planes. This area is found along a

well-traveled route, populated seacoast, or any other area which offers a great number of potential victims. As a result, many bodies often litter the floor of the lake, river, or ocean that they inhabit.

Undines have the ability to *charm monsters* as per the spell, usable once per day. By doing so, undines can command larger sea creatures (whales, giant squids, or octopi) to do their bidding. Undines use these larger creatures to destroy ships or whisk sailors from decks. Once in the water, these sailors are then attacked by the undines, who attempt to slay them. During this time, the other creatures do not attack as the undine must kill the victim themselves in order to consume their life force. An (invisible) undine grasps a person on a successful to-hit roll, which causes the victim to save vs. paralysis or become completely *paralyzed*. The victim drowns in 1-2 rounds, even if able to take a deep breath before going under. Undines are not strong, so a mobile character can easily escape from one's clutches.

Undines are naturally invisible in water, even if attacking. If an undine is losing a battle, the creature flees for its lair. Characters attempting to locate an undine must use magical means (spells or devices) to do so. In extreme cases, as when the undine's death is the probable outcome of combat, this creature may use its ability to transport itself back to the Elemental Plane of Water if no other means of escape is available. This *plane shift* ability works once per year, so they are reluctant to use it.

## WEED GIANT

FREQUENCY: *Rare*

NO. APPEARING: 1

ARMOR CLASS: 5

MOVE: //6"

HIT DICE: 8 (*brain only*)

% IN LAIR: Nil

TREASURE TYPE: *Incidental*

NO. OF ATTACKS: *1 arm strike*

DAMAGE/ATTACK: 2-16

SPECIAL ATTACKS: *Buffeting*

SPECIAL DEFENSES: *Hidden vulnerable part, weapons resistances*

MAGIC RESISTANCE: *Standard*

INTELLIGENCE: *Semi-*

ALIGNMENT: *Neutral*

SIZE: L (12' tall)

PSIONIC ABILITY: Nil

Attack/Defense Modes: Nil

LEVEL/X.P. VALUE: VI/725 + 10/hp

This creature is not a true giant, but is actually a composition of several hundred strands of semi-intelligent seaweed. The weed giant is not rooted and, although it gains food in the manner that regular seaweed does (i.e., through nutrients in the water), it also feeds by entrapping creatures or other plants in its strands and decomposing them with its digestive secretions. The weed giant then absorbs its victim(s) through its strands. In this manner, the weed giant is similar to an aquatic variation of a shambling mound.

Though composed of vegetable matter, the weed giant is an intelligent lifeform; it thinks and acts with the same instincts and drives that many animals do. The brain of this creature is at the center of its weed structure; it is from this point that the strands emanate. In order to kill a weed giant, a successful attack must be made against the creature's brain rather than against its kelp strands. Attacks made against the creature's brain are against AC 3; all other attacks are against AC 9, but do not effective hit-point damage to the monster, merely cutting away strands of weed which grow back in full in 1-4 weeks. The brain can be attacked at random 10% of the time (roll this chance before rolling to hit the necessary armor class); because the brain is mobile, it is virtually impossible to attack directly (in a nonrandom fashion).

In combat, the weed giant does 2-16 hp damage on a strike with its weedy appendages ("arms" or "legs"); if the creature misses, the displacement of water forces the victim away from the weed giant (a distance equal to 4-24') unless a save is made vs. paralysis. This water buffeting can also be employed by the weed giant to deflect any missile fire from any engine smaller than a ballista. However, unless the missiles strike the brain, they cause no damage to the weed giant at all. All edged weapons (except magical) cause only half damage against this creature; blunt weapons cause no damage at all.

**STATE OF WAR**

The year is 2000! They said it would never happen again. BUT IT HAS!!!  
CIVIL WAR IN THE U.S.!!!

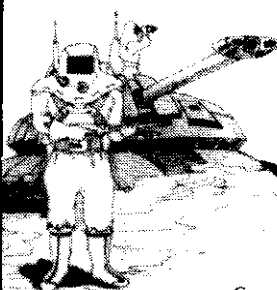

After years of foreign wars and inept leadership, twenty states attempt SECESSION in this newest Play-By-Mail game from the PBM leader. Game Systems Inc. As the GOVERNOR of the state of your choice, you must order the recruitment and placement of troops, allocate expenditures for training, industrial expansion and scientific research, and still try to keep your populace happy! With GSI's NEW "Phase" system, players can give from 50 to 100 orders per turn and receive combat results on MULTIPLE BATTLES per turn! Add this to GSI's reputation for accurate results and prompt turnaround times and you have the BEST PBM GAME EVER!!! A \$15.00 registration fee includes rules, 3-color map and 2 FREE turns. Thereafter, turns are \$4.75 each, NO HIDDEN COSTS EVER!



Game Systems Inc. P.O. Box 431870 Miami, FL 33243-1870

# Dungeon™

ADVENTURES FOR TSR® ROLE-PLAYING GAMES

needs a few good dungeons...

Write for our module guidelines. Send a self-addressed, stamped envelope to Module Guidelines, DUNGEON Adventures, P.O. Box 110, Lake Geneva, WI 53147 (9½" long envelopes preferred). We'll send you our complete guidelines for creating AD&D® and D&D® adventures to last for the ages — in the pages of DUNGEON Adventures!

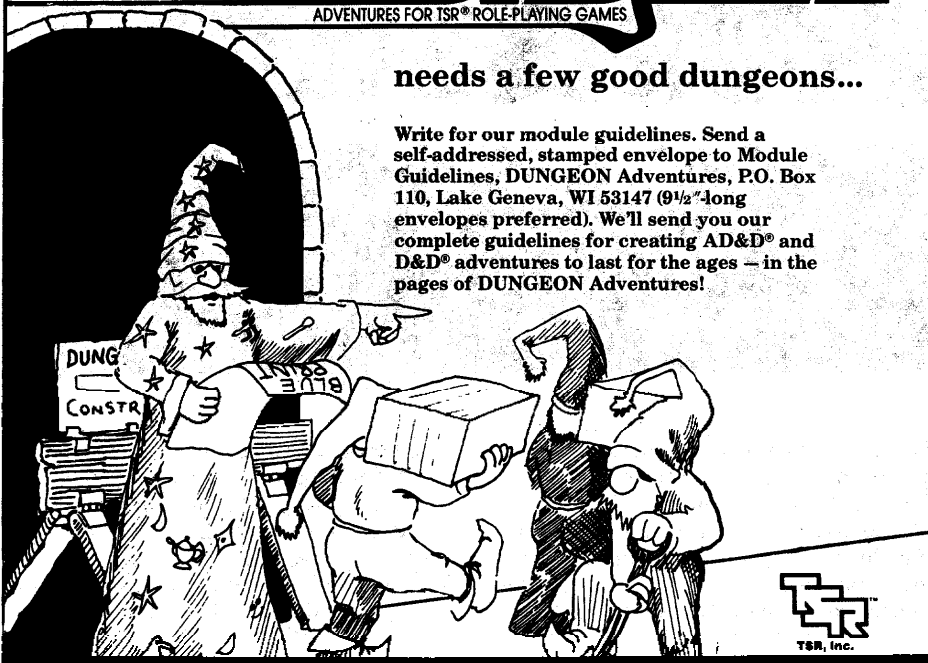

DUNGEON, AD&D, D&D, TSR, and the TSR logo are trademarks of TSR, Inc. Copyright ©1986 TSR, Inc. All Rights Reserved.

## ILLUMINATI™

The Fast, Exciting, New PBM Game Of Intrigue And Strategic Conflict

Now you can become the absolute master of one of Earth's most powerful secret organizations. Your agents eagerly await your orders. Your mission is nothing less than **Total World Domination!**

### JOIN THE PBM CONSPIRACY

- ▲ Twenty-four players per game
- ▲ Full diplomacy — make and break alliances
- ▲ Send messages through the computer
- ▲ Every player's position is different
- ▲ Every player has a unique secret power
- ▲ Clear rules with excellent examples
- ▲ Simple, easy-to-complete turnsheet
- ▲ Detailed reports on all results, in English
- ▲ No turn deadline, no missed turns
- ▲ 24-hour turnaround guaranteed
- ▲ Completely computer-moderated
- ▲ Professional management
- ▲ Over 20,000 turns processed
- ▲ \$7 (U.S.) for setup, rulebook, and 2 free turns
- ▲ Only \$4 (U.S.) per turn — never an extra charge

"Great rules, great action, just an incredibly great game!" — Jeff Ferris

"HIGHLY RECOMMENDED!" —Gaming Universal



For information, write to:

**Adventure Systems**  
P.O. Box 22305-X  
Houston, TX 77227

ILLUMINATI and the all-seeing pyramid are registered trademarks of Steve Jackson Games Incorporated. ILLUMINATI THE PLAY BY MAIL CONSPIRACY is a licensed version of S J Games' ILLUMINATI board game. All rights reserved. Fnord.

## THE BESTIARY

A compendium of creatures and beings from the lost world of Atlantis

Stephan Michael Sochi  
and J. Andrew Keith  
Illustrations by  
Bill Sienkiewicz



## The Bestiary

Encounter the strange and wondrous inhabitants of a bygone age in THE BESTIARY, a compendium of creatures and beings from the Lost World of Atlantis. Within the pages of this book, you will meet: the Alicanto, a fabulous bird that feeds on precious metals... the Hantu, so-called "earth-bound demons" of legend... the Ahl-at-Rab, warlike reptilian rulers of the desert sands... the Zazir, diminutive and industrious creators of nature's wonders... and many, many more. Illustrated by Marvel Comics artist Bill Sienkiewicz, THE BESTIARY also features a separate section with stats for hundreds of monsters and wild animals, all easily adaptable to the most popular FRP game systems.

\$14.00

Also available from Bard Games: **The Compleat Fantasy Series, The Lexicon, The Arcanum.**

Available at Waldenbooks, B. Dalton Books, and finer hobby stores in the U.S., Canada, and Australia.

**Bard Games**  
where fantasy becomes reality



# “Hello? Your Majesty?”

## *Communication in history and fantasy*

by Craig Barrett

If you want to talk to the President of the United States, all you have to do is pick up the telephone and dial the White House. Well, maybe it's not quite that simple, but at least you have a fair chance of getting the White House switchboard. Now imagine Vespasian, Nero's general in Judea in A.D. 67, picking up the phone and saying: "Give me Rome. I want to talk to the Emperor."

Boggles the mind, doesn't it? We all know that communicating across long distances was just a tad more difficult in the ancient world than it is today. But what that means in terms of specific details comes as a considerable surprise. It's not easy for us to lift our minds out of our own environment and cross the gap that separates us from the minds and methods of the people who inhabited the pre-modern world.

That phrase itself, "premodern world," goes against the grain. Living in an age of constant progress — if you bought a home computer last year, there's a fair chance that it's obsolescent already and obsolete by next year — we expect the world to have always been like it is now. Allowing for anomalies like the Dark Ages, a chart of man's experience ought to show a general upward curve of constant improvement. But, in the communications field, that isn't the case. From Egypt of the Pharaohs to Napoleonic Europe, the physical limitations of man and animal imposed unvarying dimensions of travel time on all human history. The "distance" from southern Britain to Rome was 29 days in the time of Julius Caesar, 29-30 days in the 12th century, and 30 days in 1834. Once ingenuity had improved the available methods of communications to a certain level, a peak too fleeting in most cases to be termed a "plateau," there they remained. The gap that separates that world from ours was bridged by the advent of

the steam engine and the telegraph in the 19th century. In discussing communications before that time, it's not necessary to specify "Ancient," "Medieval," or "Renaissance," but simply "premodern."

It requires another stretch of the mind to understand the unpredictability and delay that were both integral parts of pre-modern communications. Today, bad weather is little more than an inconvenience. When it's bad enough to upset our timetables by as much as two or three days, it becomes newsworthy. In the pre-modern world, such delays wouldn't even have merited a comment. Delays of three or four days were accepted without question, and delay of three or four weeks were commonplace. The sudden closing of a border or an unexpected flood could force the re-routing of a letter through country where no regular postal system existed. If a route crossed any considerable body of water, such as the Adriatic Sea or the English Channel, delays of 30-60 days were possible. Oddly, the time between Sicily and Spain could be shorter by land than by sea. A state of alert, a warning of bandits, heavy rains, or a snowfall might discourage couriers or even send them scrambling in other directions. In *Outré Mer* ("Beyond the Sea" — the Crusader dominions in the Near East), renegades and Bedouin tribesmen posed a constant threat, despite efforts on both sides of the Frankish-Moslem frontier to patrol the highways. In Europe, the situation was even worse.

As Fernand Braudel writes in his two-volume work, *The Mediterranean* (page 357), "Distances were not invariable, fixed once and for all. There might be ten or a hundred different distances, and one could never be sure in advance, before setting out or making decisions, what timetable fate would impose." A letter from Spain to Italy might go by way of Bordeaux and Lyons, or by Montpellier and Nice. In April 1601, an ambassador's

letter from Venice to the king of France reached Fontainebleau by way of Brussels. The Portuguese ambassador to Rome in the 1550s habitually sent his letters to Portugal by way of Brussels in order to avoid uncertainties. Philip II of Spain wrote (Braudel, page 357): "It is more important that the letters should travel by a safe route than that four or five days be gained, except on occasions when speed is essential."

Despite these difficulties and dangers, premodern societies did manage to keep in touch with each other. Four primary tools were employed to this end (the horse post, the foot post, the pigeon post, and the sea) with a number of lesser tools. What should come as no surprise to the modern mind is the fact that, in every case, these tools were brought to their peak of performance by sheer organization. In fact, one of the earliest systems of which we have any extensive knowledge sets the pace and pattern for all that followed.

### **The horse post**

The horse-post system of the ancient Persians was created by Darius Hystaspis (521-486 B.C.) to connect all the major centers of the Persian Empire and to provide the Great King with the most effective means of communication that the world had yet seen. Along already existing caravan routes, post houses were established at regular intervals, the intervals being the distance a horse could be expected to gallop at top speed once a day (14-18 miles). Several couriers and relays of horses were stationed at each post, and the roads between were enhanced with bridges, ferries, and guardhouses for protection against bandits. While the system itself was reserved for official use only (a theme repeated constantly throughout history), the roads were open to ordinary travelers; high-quality inns or caravanserais, presumably private commercial ventures, were available at most

post stations. Letters dispatched through the post traveled both day and night, with a fresh rider on a fresh horse taking over at each station to ensure maximum effort at every stage of the journey. Such a system could forward the official mail at a minimum rate of 50 miles per day, allowing for weather, and perhaps 75-100 miles per day (where the going was good) when top riders and horses were employed.

Five hundred years later, Caesar Augustus (31 B.C.-A.D. 14) openly used the Persian system as the model for the Roman public horse and carriage post. As an added advantage, he had the famous Roman roads at his disposal. In time, all the Mediterranean world was united by these roads: 51,000 miles of paved highways, linked by myriad secondary roads, graced by magnificent bridges, and crossing even the most formidable mountain barriers. Every Roman mile along the consular roads, a milestone gave the distance to the next town; every ten miles a *statio*, complete with a garrison of soldiers, offered fresh horses; and, every thirty miles, a *mansio* combined the services of inn, store, saloon, and brothel. Civilian travelers could purchase "itineraries," showing the routes and stopping places.

The post operated at all hours along these roads, with the public stagecoaches averaging 60 miles per day, while the horse post (like the Persian, reserved for official use) averaged 100 miles per day. Commercial mail services may also have been available for private use, as a supplement to hired messengers. Employing this network of roads and stations, some remarkable feats were possible. Julius Caesar once covered 800 miles in eight days by carriage. Tiberius (A.D. 14-37), riding day and night to reach his dying brother, made 600 miles in three days. The news of the death of Nero (A.D. 68-69) reached Galba, 332 miles away in Spain, in 36 hours by messenger. After the decline of Rome, it would be a long, long time before Europe again experienced this level of ease and efficiency in communications.

For a time, the system of post roads was maintained by the Byzantines in their portion of the empire. The Imperial mail system, the *verdus*, later became the *berid* postal network of the Moslem kingdoms, losing something in efficiency due to the fragmentation of authority, but gaining the improved horsemanship of the steppe peoples who were filtering down into the Near East. The first great Mamluk sultan, Baibars the Panther (1260-1277), himself nomad-bred, reorganized the *berid* after the fall of Baghdad to the Mongols, and thenceforth its center was Cairo. Under his direction, the *berid* reached its zenith, with reports coming into Cairo twice a week from throughout the Mamluk domain, messages traveling at a rate of 120 miles per day.

It was in the Far East, however, united by the conquests of Genghis Khan (1206-1227), that the horse post achieved its best

development in the form of the Mongol *yam*. Originally a military instrument by which the Khan kept in touch with his far-flung armies, the *yam* linked together centuries-old caravan routes through postcamps of strings of relay horses and a few guards, set at 50- to 100-mile intervals. By the time of Marco Polo's visit to the court of Genghis' grandson, Kublai Khan (1260-1295), the interval between post stations had closed to 25 to 30 miles, and the daily rate of the Khan's couriers had increased from 100-150 miles per day to 200-250 miles per day, with a fresh rider and mount taking over at each station in true relay fashion. At three-mile intervals between horse stations, smaller villages served the foot post and also provided torch bearers to escort mounted couriers so that the Khan's post could operate day and night.

All this was under the authority of the district *daroga* (road governor), who had absolute power to requisition whatever was needed for the *yam*. Couriers also had the power to commandeer horses at need. Each courier carried a "gerfalcon tablet" as his authorization — as Baibars' riders carried silver plaques about their necks and yellow scarves to distinguish themselves — and wore a wide bell-mounted belt to alert the riders at the next station of their approach. Unlike the situation in the West, Mongol carriers had no fear of interference from brigands or renegades; the Mongols were absolute masters of the roads, and legend has it that the "Pax Mongolica" was so thorough that a blonde virgin riding a white horse and carrying a sack of gold could ride from one end of the Mongol domain to the other unmo- lested. As proof of the efficiency of the post, Marco Polo relates that fruit picked one morning in Kambalu could be served on the evening of the following day to the Grand Khan at Chandu, normally a ten-day journey away.

Without intensive organization such as these empires used, the scope of the mounted couriers was considerably smaller. On the average, a single rider cannot expect to do more than 50 to 60 miles in a day, unless he's prepared to kill his horse in the process. These figures are cited for the ancient Persians and Greeks, the Franks of Outré Mer, and even for the nomads of High Asia prior to and after the Mongol dominion. Adverse road and weather conditions can reduce speeds even further. In *A Wargamer's Guide to the Crusades*, Ian Heath writes that winter rains could turn the roads of Outré Mer into quagmires of clinging mud, bringing travel of any sort to a seven- or eight-mile-per-day crawl. Even normal winter conditions allowed only a 30-mile day for dispatch riders, and the fierce heat of the Syrian sun, permitting only eight hours of riding time, made 60 miles per day an accomplishment in summer — and this assumes that couriers obtained fresh horses at whatever cities and castles hap-

pened to be located along their route.

In the West, not even token repairs had been made on Roman highways ravaged by war and weather. Although a regular post reappeared in 12th-century Italy, it wasn't until the 13th century that Western rulers began taking steps to turn highways from troughs of dust and mud into usable roads. While both religious and secular magnates kept private couriers in personal attendance — the King of England had a dozen, the King of France 100 — it was from the dominant commercial centers such as Bruges and Venice that the resurgence of good communications came. These states were capable of sending a letter or small package 700 miles in seven days. By the 15th century, Venice's administration and postal service (open to private as well as public correspondence and parcels, for once) was the finest in Europe. In the 16th century, a regular postal service was developed by Gabriel de Tassis for the Italy-Brussels route, using the Tyrol pass and a carefully planned itinerary. Tassis couriers covered 475 miles in five and a half days — only 86 miles per day, but a regularly achievable speed that was considered the best in Europe at the time.

This is not to say that the mails always, or even frequently, operated at these peaks. When the Emperor Frederick Barbarossa (1152-1190) died in Cilicia (the coast country of south-central Turkey) during the Third Crusade, it was four months before his German Reich learned of the fact. While the word of the birth of the grandson of Francois I (1515-1547) traveled 130 miles per day to reach Fountainbleau in two days, the equally vital news of the St. Bartholomew Massacre in Paris (Aug. 24, 1572) traveled only 62 miles per day to reach Madrid on September 7.

It costs money as well as interest to make the news travel fast. For rich merchants and governments, the news was less a matter of luxury than of vital necessity, and they paid the prices. Between the neighboring cities of Venice and Ferrara, couriers demanded a ducat per letter. One courier sent from Chartres to Toledo and back in July of 1560 covered 179 stages (of 6-7½ miles each) at 54 miles per day, and was paid two ducats per stage — 358 ducats. (By way of comparison, in 1538 the hull of a war galley cost 1,000 ducats, and a galley cost 2,253 ducats.) Braudel tells us (page 365) that between Venice and Nuremberg, the cost depended on the speed: "4 days, 58 florins; 4 days and 6 hours, 50 florins; 5 days, 24 florins; 6 days, 25." (According to Will Durant, *The Reformation*, page x, the florin had the same approximate value as the ducat; in 1460, a rich man's maid in Florence was paid eight florins a year.)

The horse post was the most common of the premodern communications methods, and in some ways the surest and most convenient. But where sheer speed was concerned, there were better tools, and man himself was one of them.

## The foot post

Victor von Hagen writes (*Realm of the Incas*, page 177): "Man can outlast any animal, including the horse." The history of the foot post as a tool of communication proves his point.

Ancient Greece was a land unsuitable for horse traffic. Roads were little more than dirt tracks; the Sacred Way from Athens to Eleusis, the finest road available, was only packed dirt, and narrow besides. Streams were unbridged except by earthen dikes that a spring flood could easily wash away. Since no postal system existed — even for governments — communication by king and private citizen alike was by hired runner. But these runners could make the 160 miles from Athens to Argos and back in a respectable two days, and the 85 miles from Plataea (30 miles northwest of Athens) to Delphi (in central Greece) and back was only a one-day run.

The impact of horse, pigeon, and distance largely eclipsed the foot post in later European history. The runners of the Middle Ages averaged only 20-25 miles per day on roads that were certainly no worse than those of the Greeks. In the Far East, however, the Mongols established a foot post in conjunction with their horse-post system. The Khan's runners were stationed in villages every three miles along the major roads. Like the riders, the runners wore bells attached to their belts to warn of their approach. The system was organized as a relay so that each runner covered only three miles before passing his burden on to the next man in line.

There were no horses at all in Incan Peru when the Spanish Conquistadors arrived (1531) to discover a mail system that equaled or surpassed anything else in the premodern world. Like the Roman system, the Incan depended on the use of excellent roads, and the Incan roads rank with the Roman in terms of engineering accomplishment. At 3,250 miles, the Andean "royal road" was the longest in the world. Along the entire length of the desert coast, a second arterial road stretched 2,520 miles. Lateral roads branching off the two main arteries completed a total of more than 10,000 miles of major all-weather highways. Through terracing, sophisticated drainage techniques, causeways, step roads, bridges specifically designed to meet specific needs, and side-wall borders to mark the way and to cut down on snow and wind drifts, the Incas overcame all obstacles and virtually eliminated all but the worst weather-induced delays. Incan road markers (*topos*), similar to the Roman, were set up every four and a half miles to give distances. Post houses (*tampus*) of varying size were spaced every 18 miles in level country, every 12 miles if the road went up or down the side of a mountain, and as water allowed in desert areas. The upkeep of this, and of the postal system itself, was

the responsibility of the local communities.

The local communities thus provided the trained runners who served in pairs for 15-day shifts in the *chasquis* (pronounced CHAS-ki) huts (*o'kla*) that were set every one and a half miles along the roads. The runners were badged and sworn to such absolute secrecy concerning the mail they handled that not even torture at the hands of expert Spanish inquisitors could make them betray their trust. When a message was dispatched, each runner would carry it only the distance to the next station and there pass it on — a verbal key as well as the knot-string recordkeeper that served the Incas in lieu of writing — to the next runner, who would continue the relay. These runners are chronicled as accomplishing the incredible feat of relaying messages from Quito to Cuzco, 1,250 miles at altitudes ranging from 6,000 to 17,000 feet, in just five days — a rate of 250 miles per day! Fresh fish was sent daily 130 miles from the sea to the Lord-Inca in Cuzco.

It's well to remember, in the face of this achievement, that on October 27, 1985, the New York marathon was won by *one* person, not a relay, with a time of 131.5 + minutes, approximately five minutes to the mile. Every Incan runner was a skilled athlete who served in his home area so that he could be indifferent to the altitude and totally familiar with the three-mile section in which he served, even to the point of running it at full speed at night, and all this was done on the splendid Incan roads. Running 250 miles per day was probably a maximum achievement, but the average would not have been too far below it. Contemporary Europe had nothing to match this postal system. The Spanish colonial government continued to employ it until the 19th century.

## The pigeon post

Another premodern postal system, the pigeon post, continued in use well into the 20th century. The discovery of carrier pigeons aboard captured German trawlers as early in World War I as August 5, 1914, implying the trawlers were informants for submarines, added significantly to the worries of British Admiral Jellicoe. In December of 1944, the ace paratroop commander Colonel Friedrich von der Heydte asked to take carrier pigeons along when he landed behind American lines during the early stages of the Ardennes offensive. Permission was refused, and events turned out as the colonel had feared: the paratroopers' radios were damaged in landing, and without pigeons, Von der Heydte was unable to relay to his superiors vital information concerning American troop movements.

The use of carrier pigeons, dating back as far as the ancient Greeks, shows up best in the hands of the Arab and Mamluk rulers of the pre-Crusade and the Crusading eras. During the Abbasid (750-c. 1100)

and Fatimid (968-1171) Caliphates, the pigeon post spanned the Arab dominions, and top homing pigeons could sell for 700 to 1,000 dinars on the open market; the egg of a pedigreed pigeon was worth 20 dinars (approximately 2.7 ounces of gold). The Damascus-to-Cairo post of Nur ed-Din, atabeg of Damascus and Aleppo (1146-1174), used a system of "cot" stations where letters were relayed from pigeon to fresh pigeon at every stage in the journey.

But the peak of this post comes, as with the *berid*, under Baibars the Panther. Cot (or loft) relay stations were established along all the major routes of the Mamluk domain, and the Sultan kept other pigeons with him wherever he went, ready to carry his orders to any part of the empire at a moment's notice. Each pigeon flew only the distance between the station where he was normally kept and his home cot, where the message was transferred to a new carrier. After sufficient pigeons accumulated, the pigeons were returned to their "ready" stations by mule transport. The average station might house several hundred pigeons, but the Citadel of Cairo, the empire's communications hub, kept as many as nineteen hundred pigeons ready for service in its lofts. Presumably, some of these had their home cots at the next relay stage along the roads out of Cairo, while others had their home cots in distant cities and could be used when considerations of speed or security required direct contact with the Sultan's generals and governors. Security also affected messages coming in to the Cairo citadel, for some were marked for the Sultan's eyes only, and Baibars gave instructions that these should not be removed by any hand other than his own. Whether eating, sleeping, at conference, or playing polo, the Sultan was to be notified immediately of the arrival of these pigeons, for every moment was critical.

The speed of pigeons varies with conditions and from bird to bird, maximums being approximately 60 MPH in windless conditions and 110 MPH with a powerful following wind; less, of course, bucking a strong head-wind. Letters were tied under the wing rather than on the leg, for protection against the weather, and pigeons were never released at night, when hungry, or during inclement weather, as a precaution against their landing or wandering between stations. Range was about 500 miles per day for ease, but relay stations were placed closer together than that when possible. Only male pigeons were used as letter carriers by the Moslems. State-owned pigeons were branded on foot or beak, and registers were kept showing their home cot, pedigree, value, and history — a formidable task, considering the volume of pigeons in use. The Fatimid Caliph Azeez one day decided that he wanted to feast on the fresh cherries of Baalbek in Lebanon, so an order was sent out by pigeon. Three days later, the Caliph and his entourage feasted on 1,200 fresh



Lebanese cherries, brought to him tied one cherry each in a silk bag) to the legs of 600 pigeons.

The pigeon post has its disadvantages, though. As Ian Heath points out, modern magicians show how easy it is for a spy to secret a pigeon or two about his person, but since pigeons fly only to their home cots, that does no good if he has the wrong pigeons. However vast the number of carriers employed, you can't send a letter if you don't have an available pigeon tagged for the appropriate destination, and the farther away the home cot the longer you have to wait for the pigeon to be returned to you for future use. In a fantasy world, this problem could be overcome by a magical spell that can direct a pigeon to the destination of the sender's choice, or (combined with a direction-finding or object-locating spell) can even cause a pigeon to hunt out a specific individual. Such spells, vastly increasing a ruler's range of communications, might easily be the most valuable service a court magician could perform for his master!

Pigeons are also limited in the weight they can carry. Letters must be short, expressing only main ideas or possibly using a code where each word carries a wider meaning for the recipient. In 1281, when the governor of Hama sent to Sultan Qalaoon a warning of the already-expected approach of the Mongol army of Mangu Timur, he said only: "The enemy numbers eighty thousand. Tell the sultan to strengthen the left wing of the Mamluk army." (Sir John Glubb, *Soldiers of Fortune*, page 112) In order to allow for longer messages, the Mamluks experimented with special thin paper. Magic could expand on this by devising psychic messages so that merely holding the paper could express entire paragraphs directly to the mind of the receiver — perhaps even limiting the message to a *specific* receiver, with no one else who handles the paper able to receive any message at all.

Finally, as with other posts, pigeon messengers can be lost or intercepted. The *Guinness Book of World Records* reports of one pigeon released in Europe that arrived in Australia, and another that took seven years to go 370 miles — rare occurrences, but possible. Less rare are the chances of weather or predators bringing down a bird — or an enemy archer or falconer in the right place at the right time. The sky is a big place, and these chances are seldom recorded as having happened, but the danger is sufficient that, in some cases, pigeons were released in pairs to guard against the miscarriage of important messages. Once more, magic can help here, producing spells to make carriers less detectable or to protect them against arrows and falcons. But then, the magic itself may be detectable, or the enemy may have magically controlled falcons for "anti-pigeon" patrols. Most important of all would be some means of

identification from the ground so that hunters would not accidentally bring down their own master's messenger pigeons. The Sultan would not be very happy about *that!*

### The sea

As a highway for commerce, the sea was and is unsurpassed. In the premodern age, land communications, while slower and more expensive, were usually favored above sea communications. The latter were simply too unpredictable. Fernand Braudel writes (*The Mediterranean*, page 357): "The struggle against distance might remain a matter of constant vigilance, but it was also one of chance and luck. At sea, favorable wind and a spell of fine weather might make the difference between taking six months for a voyage or completing it in a week or two. Pierre Belon sailed from the Sea of Marmara to Venice in thirteen days, a journey which frequently took half a year."

Vessels might be forced to stop indefinitely in safe havens when the weather was prohibitive. In 50 B.C., Cicero waited three weeks to cross the Adriatic from Patras to Brindisi, and St. Paul was forced to spend an entire winter at Malta during one voyage. In the Middle Ages, the English Channel crossing was known to be particularly hazardous and time-consuming, varying from three days in moderate weather to a month in bad; one knight was kept at sea 15 days in a storm, and landed much the worse for wear. In January 1610, a Venetian ambassador to England was two full weeks at Calais waiting for the weather to abate, and, in June 1609, a Venetian ship headed for Constantinople spent 18 days sheltering from a storm at Chios.

Against this background, it's possible to calculate the potential speed of voyages, remembering that communications is a matter for single ships rather than fleets (which move at the speed of their slowest members), and that record voyages are exceptions from the norm.

"In the 4th century B.C., a favorable wind might allow a high speed of six to seven knots. Record voyages include 170 nautical miles (Cotyora to Sinope, along the eastern end of the Black Sea coast of modern Turkey) in a day and a night; 190 miles (Sinope to Heracleia, on the western part of Turkey's Black Sea coast) in 2 days; 125 miles (Heracleia to Byzantium, modern Istanbul) in 16 to 18 hours. Average speed for a long journey with a light wind and no halts was four to five knots (290 miles from Lampsacos, a city on the Dardanelles, to the Laconian Coast, the southeastern coast of the Peloponnesos district of modern Greece, in three days and three nights), but usually there was no rowing at night and 65 to 80 nautical miles in a 16-hour day was common in the good season." Will Durant reports that some fast Roman cruisers made 230 nautical miles in 24 hours, but, in the 16th century, the

fastest speeds at sea were barely over 108 nautical miles in a day, under the most favorable conditions and with elite ships. On May 23, 1509, Cardinal Cisneros crossed from Oran to Cartagena, 108 nautical miles, in one day, and it was considered a "miraculous" feat, as if he had commanded the wind itself. Obviously, not all things improve with age.

Well-designed ships and well-cared-for crews (remembering that classical oarsmen were not slaves but free) are important factors in record voyages. Lionel Casson writes that in the 1st century B.C., an ordinary vessel could make 70 nautical miles in one day at three knots, while a well-made ship could make 90 nautical miles in one day at four knots. Based on this, he gives average speeds for ancient vessels over open water of four to six knots, with speed reduced during the time-consuming tasks of working through islands or of coasting. With a favorable wind, a solitary trireme could average four and a half knots (325 nautical miles in three days). Against the wind, the average would be reduced to two or two and a half knots. The Greeks also recognized that a trireme just out of dry-dock was faster and more maneuverable than a ship which had been at sea for some time and whose timbers had become waterlogged and heavy — just as long-service ships in sailing times would be burdened with barnacles and slower than ships which had been freshly scraped. This problem, at least, might be relieved in a fantasy world where alchemists can provide a ruler's navy with effective, water-resistant varnishes. The formulas for the varnishes would be state secrets, as carefully protected as the secret of Greek Fire was by the Byzantines, and as much sought-after by foreign spies. Other aids from magic could be potions to keep up the strength of oarsmen, even at some cost to vital life forces, or spells to control the weather (at least in limited areas) so that a voyager can duplicate the feat of Cardinal Cisneros and "hold the wind in his hands." All of these would be valuable both for dispatch boats and fleet actions.

### Exotica

In addition to the major communications systems, some minor ones were of particular value. Beacons — sun telegraph, fire telegraph, smoke signals — can be solitary or part of a network, and their use dates from the first time a hostile fleet appeared on an unguarded coast. The Romans used torches and a simple semaphore code, while the Byzantines had a sophisticated heliograph system to transmit news of invasions or disasters across the empire. The beacon tower of Constantinople was within sight of the emperor's residence. A chain of beacon towers along the coast of Syria in the 10th century could flash news from Antioch to Cairo in an hour's time, and was used later by the Mamluks to give

warning of the Mongol invasions. The Franks heavily favored the use of beacons. While the sites of their castles were chosen for a variety of reasons, many were in line of sight of each other so that messages could be exchanged. When Saladin besieged the Crusader castle of Kerak in Moab (southeast of Jerusalem across the Dead Sea) in 1183, a signal beacon summoned relief from Jerusalem, 50 miles away. In the maps of *A Wargamer's Guide to the Crusades*, Ian Heath notes many instances of this line-of-sight placement. The use of heliographs endured so long that Alexandre Dumas used the device in *The Count of Monte Cristo* as a means for his title character to destroy an enemy — a clear warning that telegraph operators are not above being bribed or otherwise interfered with. Lacking telescopes for precision sighting, however, probably nothing as detailed and accurate as the modern semaphore or the sophisticated flag codes of the British navy was possible through most of the premodern era.

More esoteric is a story told by Farley Mowat in *Never Cry Wolf*. Working with an eskimo hunter named Ootek, Mowat was startled one day when Ootek pointed to a range of hills five miles north and said, "Listen, wolves are talking." Mowat heard nothing, though he noticed a nearby wolf, asleep until then, was also watching the hills. After listening for a couple of

minutes, the nearby wolf raised a quavering howl that ended on high notes above normal human hearing. "Caribou are coming," Ootek reported. "The wolf says so!" And he explained that the wolf in the next territory north had been passing the word — passed to him by another wolf even further north — that the long awaited caribou migration had started, and had even specified their present location. The nearby wolf had then acknowledged the news and passed it further along. Mowat was skeptical, and remained so even when another friend named Mike promptly went hunting, and returned three days later with venison to spare. The caribou, Mike said, had been 40 miles northeast on the shores of Lake Koiak, exactly where the wolves said they would be. He added that wolves could "talk" almost as well as people and easily communicate at great distances, and that some Eskimos could literally converse with them.

Coincidence? Yet an interesting story comes from the Spanish-speaking Canary Island of La Gomera. While the outdoor range of a male human voice in still air is only 200 yards, the islanders speaking the whistled *silbo* language can, under ideal conditions, communicate across valleys at a distance of five miles (*Guinness Book of World Records*, 1975, page 46). The Basque shepherders and the Swiss moun-

taineers possess similar abilities. While the range of whistlers or yodelers depends on weather, altitude, and the capacity of the surrounding terrain to reflect or absorb sound, the principle remains useful. This is particularly so when a fantasy world can combine it with animal communication, and enhance it with low-level magic native to given rural districts. Establishing relay stations isn't necessary when a succession of mountain farmers and herders who are used to "talking" to each other are able and willing to pass the news along in this way! Allowing for the general conservative attitude of scientists and researchers, we can even consider the five-mile range to be normal rather than exceptional, with wolves able to "talk" even farther.

Another method of rural communication is the somewhat more specious notion of Robin Hood's famous "whistling arrows," used to speed messages across Sherwood Forest. The premodern record for long shooting belonged to Sultan Selim III (953 or 972 yards in 1798), while the 1975 records are held by Harry Drake of Lakeside, California: 856 yards 20 inches with the handbow, 1,359 yards 29 inches with the crossbow, and 1 mile 101 yards 21 inches with the footbow (*Guinness*, page 494). If we accept that Robin Hood's men could fire an arrow 880 yards through the forest sky, that requires two men per mile who must be in a specified locale at a specified time to speed the message on its way. Such a method is a little wasteful of manpower, but could be valuable to get important information across dangerous terrain, and to do it secretly. The trick would be arranging for enough top-grade archers to be where the arrows are landing just when they're needed. In heavy forest country, where isolated farms are virtually immune to interference and where the necessarily fixed nature of road travel guarantees that your lines of communication will remain static, the procedure almost makes sense.

In realms of pure fantasy, an enormous number of devices, perhaps not originally intended for the purpose, can serve as tools of communication. The fabled "Seven League Boots" that enable the wearer to cover 21 miles at a single stride would be invaluable for special couriers. The "talaria" or winged sandals of Hermes would also be of use. The wings of Daedalus, manufactured to allow him and his son Icarus to flee Crete, and fatal to Icarus when he flew too close to the sun and the melting wax of the wings plunged him into the sea, could be employed. The trouble with devices like these is that they're usually one-of-a-kind items. They may serve for a single individual, the prime courier of a god or a king, but they hardly allow for a communications network.

The same holds true for flying creatures, such as a roc or a pegasus tamed to the use of man. Unless you have an entire herd of them, you can't expect to set up a

## READY TO PLAY A GAME TOUGHER THAN WARGAMES?

**GO** requires the skill of a Grandmaster and the courage of a Samurai warrior! It's Japan's most popular board game.

The game appears remarkably simple. You only need a board, a set of stones, and a few easy rules. Playing is not as simple. GO requires the use of subtle strategy. The objective is to conquer territory. Position, influence, sacrifices, feints, and indirect attacks are keys to winning.

Expert players strive to make efficient moves that simultaneously attack and defend, as part of their overall strategy. As in real warfare and business, it is possible to win all the skirmishes, yet lose the war.

Ishi Press International offers by mail a complete selection of quality GO sets and instruction books—Write For Our FREE Catalog.

**HOW TO ORDER:** BY MAIL send your Name, Address & Phone No. with your Personal Check, Money Order, or charge it via Visa or MasterCard (with your card no., expir. date & sig.), for the amount of purchase, plus \$2.85 for P/H (CA Res. add 6½% Sls. Tax); OR PHONE (415) 964-7294 during bus. hrs. PST.



**ISHI PRESS INTERNATIONAL, Dept. D2**  
1101 San Antonio Road., #302  
Mountain View, CA 94043

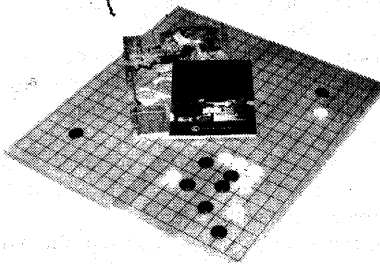

**STANDARD GO SET:** Full size 19 x 19 grid, solid Katsura wood folding board with felt backing, 18" x 16½" x ¾"; 361-pc. set of plastic stones 7.0mm thick, 181 blk. & 180 wht.; 92-pg. instruction book, "AN INTRODUCTION TO GO"; plus a FREE issue of GO WORLD Magazine ..... **\$39.95**

**Your Satisfaction Guaranteed  
Or Your Money Back!**

postal relay, and if you do have an entire herd, as Lew Pulsipher makes clear in his article, "The Fights of Fantasy" (DRAGON® issue #79), you have better uses for them than making mail runs. In addition, creatures large enough to carry a man through the sky have other liabilities. They're a lot more visible than pigeons, haven't any chance of blending "anonymously" into their surroundings, and make inviting targets for any mage with the power to strike at them.

Other courier techniques might include teleportation, *dimension doors*, some sort of potion to increase the speed with which a man or a horse can run (at some cost to life energy), or even supernatural messengers or astral travel. At sea, dolphins can make 40 to 60 knots and are six to ten times faster than the fastest dispatch boats, if you can control them. All have advantages and disadvantages (overkill being one of the latter). For emergency use, when you take chances and pay prices you wouldn't normally consider, all may be viable.

Crystal balls armed with *clairaudience* and *ESP* offer more promise. Just half a dozen can link major cities and fortresses together. For independent mages, the difficulty in using them would be arranging to have both sending and receiving parties on-line simultaneously, in an age when "synchronize your watches" has no significance. But, in the case of societies analogous to the Templars, Hospitalers, or Assassins of the Crusading era, it's entirely conceivable that trained adepts would be standing by, day or night, to receive messages. Dedicated monks would have no problem with this, and conditions of perpetual warfare such as existed in Outré Mer during the Crusades would provide incentive for the duty.

Last, but very far from least, there's that most excellent message system popularized by the TV series "M\*A\*S\*H" — the "latrino-gram." Rumor and scuttlebutt can be remarkably accurate, and can travel faster even than the speeding news release. Given the security skills of the pre-modern world — or even of the modern world, some would say — it's not impossible that at the moment a special courier is whispering a top-secret message into the king's ear up in the palace, the bosun of the ship that brought the courier is regaling his companions in the local tavern with precisely the same tidbit of juicy gossip. In ancient Greece, commercial information services developed in the larger ports, fed by hard news and soft rumor gleaned from incoming ships and caravans. Gustave Glotz writes (*Ancient Greece at Work*, page 293): "Those firms which had correspondents at a certain number of centers could form a private information agency." The same would hold true for all ages and all societies, and for trade centers located inland as well as on the coasts. The medieval Jews had an international information network second

to none. Kings could hardly match rich merchants in this potential and were prepared to buy and sell news through these unofficial organizations. Never underestimate the power of unauthorized intelligence dissemination!

Be it by courier or ship, crystal ball or gossip, the news has a way of getting around. This has been a mere sampling of the more prominent methods our premodern ancestors used to help it on its way. In the following article are some tips on how those methods can be translated into fantasy role-playing terms. But don't be afraid to experiment on your own. You just might come up with something nobody's ever thought of before.

### Bibliography

Braudel, Fernand. *The Mediterranean*. New York: Harper & Row, 1976.

Casson, Lionel. *Ships and Seamanship in the Ancient World*. Princeton: (no publisher), 1971.

Durant, Will. *Caesar and Christ*, from *The Story of Civilization*, Vol. III. New York: Simon & Schuster, 1954.

Durant, Will. *The Age of Faith*, from *The Story of Civilization*, Vol. IV. New York: Simon & Schuster, 1954.

Durant, Will. *The Reformation*, from *The Story of Civilization*, Vol. VI. New York: Simon & Schuster, 1957.

Elstob, Peter. *Hitler's Last Offensive*. New York: Ballantine Books, 1973.

Glotz, Gustave. *Ancient Greece at Work*. London: Routledge & Kegan Paul, Ltd., 1965.

Glubb, Sir John. *Soldiers of Fortune*. New York: Stein & Day, 1973.

Heath, Ian. *A Wargamer's Guide to the Crusades*. Cambridge: Patrick Stephens, 1980.

Lamb, Harold. *Genghis Khan*. New York: Bantam Books, 1963.

McWhirter, Norris, and Ross McWhirter. *Guinness Book of World Records — 1975*. New York: Bantam Books, 1975.

Mowat, Farley. *Never Cry Wolf*. New York: Dell Publishing Co., 1977.

Polo, Marco. *The Travels of Marco Polo*. trans. William Marsden. New York: Dell Publishing Co., 1961.

Pulsipher, Lew. "The Fights of Fantasy," *DRAGON Magazine* 79 (November, 1983).

Rawlinson, George. *The Seven Great Monarchies of the Ancient Eastern World*, Vol II. New York: Hooper, Clarke & Co. (no date given).

Tuchman, Barbara. *A Distant Mirror*. New York: Ballantine Books, 1978.

Tuchman, Barbara. *The Guns of August*. New York: Dell Publishing Co., Inc., 1969.

Von Hagen, Victor. *Realm of the Incas*. New York: The New American Library, 1961.

‡

# Join the Revolution!

## PHOENIX COMMAND™

**Revolutionary new man-to-man  
small arms combat system!**

Phoenix Command combines accurate simulation of gunshot wounds with detailed aiming and firing rules, and authentic modern weapon data to create a simple, fast-paced game with an incredibly realistic feel. For use with any role-playing game or as a stand-alone system. **Over 140 fully illustrated weapons! \$18.95**

Look for the fully illustrated **Civilian and Police Weapon Data Supplement!**

For more information, contact your local retailer or write to us directly at:

**Leading Edge Games  
P.O. Box 70669,  
Pasadena, CA 91107  
818/798-8290**



# LEADING EDGE

G A M E S



# High Seas in 3-D.

*A special game accessory  
for your favorite role-playing game*

## Design by Dennis Kauth

When we were putting this issue of the magazine together, one of us recalled that Dennis Kauth, our special-effects man in the graphic arts department, had created a three-dimensional fold-up ship. Dennis quickly produced the ship, we took a look at it, and plans were immediately made to jam it into this issue along with the rest of our Maritime Adventures selections – yo, ho, ho.

Then came the problem of putting it together. Now, the most experience that any of your editorial staff ever had with boating occurred when Robin Jenkins was fished out of the aquarium at Roy's Bean-O-Rama in Riptide, IL. Roger Raupp claims to have once seen pictures of boats in a library book he dropped into a lawn mower, and Pat Price served on a pigboat when he was in the Milwaukee Navy, but his boat was lost when they drained the swamp. This left me – actually, Marilyn and myself; only Marilyn's best with sheep imitations – and, with only four hours left until this issue went off to the printer, I took computer keyboard in hand and set about creating these instructions.

## Order of assembly

Carefully cut out each piece of the ship as you need it. Cutting out the pieces too early often leads to confusion and misplacing needed parts (the parts themselves are not numbered). A hobby knife and a straightedge serve well for experienced hobbyists; otherwise, a sharp pair of scissors is suitable. White glue is best for attaching the parts together permanently; be careful not to overuse it.

The arrows and dotted lines on the cut-out sheets indicate places which are folded, NOT cut. Carefully score along these lines with a knife without cutting through the paper.

**Step 1:** The hull is assembled as shown, using parts 1, 2, 3, and 4. Make sure that the colored part of 4 faces up, and those of parts 1-3 face out.

**Step 2:** The stern assembly consists of parts 5 and 6. Note that the single door on 5 is in the hold when the model is assembled. Ensure that the tabs on 6 are attached to 5, the latter with colored side up, forming the quarter-deck floor.

**Step 3:** The forecastle assembly consists of parts 8 and 9. As was done in step 2, ensure that 8 has its colored side up and forms a floor inside 9.

**Step 4** (not pictured): The rudder (7) is easily assembled. Test fit the finished rudder to the stern (along the white strip).

**Step 5:** Fit the rudder (7), stern assembly (6), and forecastle (9) to the hull (1). A certain amount of "fudging" with the placement of these parts is allowed. It might be a good idea to set the stern assembly back far enough to make room for the main deck floor and superstructure, which will be attached later.

**Step 6:** The superstructure/main deck assembly is a little difficult to manage, but a trial run is of great help (see the helpful hints below). Parts 15 and 16 essentially wrap around each other, with parts 13 and 14 forming cross-struts. Note that the notch in 13 was cut to allow part 17 (and the mast) to pass through it.

Once the superstructure is finished, attach it to the BOTTOM of the main deck (12). If you've cut out the hole for the mast in 12 beforehand, fitting these parts together is much easier. Perform test fits (without glue) to section is properly done.

The superstructure was made heavy on purpose, to hold up 25-mm lead miniatures.

**Step 7:** The crow's nest consists of parts 19 and 20. Make sure that the floor (19) has its colored side up, and that a hole is cut in it for the mast (I didn't do this when I put my own ship together – talk about trouble).

**Step 8:** Fold the mast (21) together and place the crow's nest on it. You might want to consider fixing a yard arm to the mast at this point (see helpful hints, below).

**Step 9:** The quarters (10), which fit on top of the quarter deck, are easily assembled (colored side out).

**Step 10:** The stairs (11) are also easily assembled, unless you are like some of the game designers here who mistook this part for a nose warmer. Takes all kinds.

**Step 11:** Fixing the stairs (11) to the quarters (10) is quite easy, too.

**Step 12** (not pictured): Glue the quarters (10) to the quarter deck. Also assemble the pilothouse (18) and fix it to the main deck (on the square drawn near the stern); keep the roof sloped forward so the doors in the back of the pilothouse face the stern.

**Step 13** (not pictured): Stop gluing things. The mast should be free to be removed from the ship (in case a dragon turtle takes a liking to it), and the main deck should also be freely removed. If using miniatures, action can be conducted simultaneously on main and hold decks. You are finished.

So, what type of ship is this? Dennis said it was a carrack, but when I showed my finished ship to Roger, he said it was a caravel, which sounded like a candy bar, but I later looked it up and decided it was a cog. No matter. I've used ship models like this one for a number of AD&D® games, and they've performed beautifully. Nothing matches the thrill of watching your players' faces when giant octopi mistake the ship for a huggable doll, or when the 172nd Sahuagin Marine Division climbs aboard in search of amusement.

All you, as the Dungeon Master, need is a thinly veiled excuse to get everyone's favorite character out for a short boating cruise, and – ZAMMO! It's *Voyage to the Bottom of the Sea* time! Seriously, this does work well for adventures in many fantasy game systems. Enjoy.

## Helpful hints

It is a good idea to photocopy the ship patterns and put a crude model of the ship together using tape before actually assembling the plans as they are. I did this and found that it cleared up a lot of misunderstandings about the assembly instructions, leading to a much-improved final model.

When assembling your photocopied model, note which areas are not colored in (insides of the railings, railing around the main deck to port and starboard, etc.). These areas can then be colored in on the final ship pieces prior to assembly.

## Parts list

- |                                |                               |                               |
|--------------------------------|-------------------------------|-------------------------------|
| 1. Hull, starboard side        | 8. Forecastle floor           | 15. Side/stern superstructure |
| 2. Hull, port side             | 9. Forecastle railing         | 16. Side/how superstructure   |
| 3. Hull, stern                 | 10. Quarters and poop deck    | 17. Mast foundation           |
| 4. Hold floor                  | 11. Stairs to poop deck       | 18. Pilothouse                |
| 5. Hold cabin and quarter deck | 12. Main deck                 | 19. Crow's nest floor         |
| 6. Stern railing               | 13. Bow bar, superstructure   | 20. Crow's nest railing       |
| 7. Rudder                      | 14. Stern bar, superstructure | 21. Mast                      |

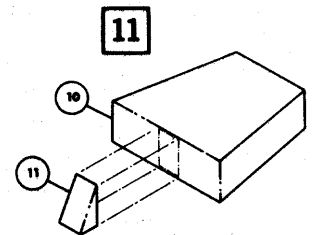
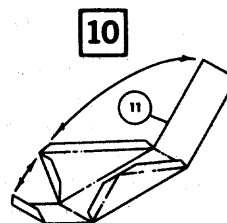
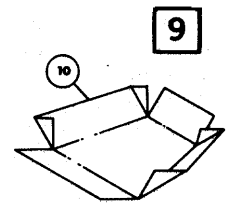
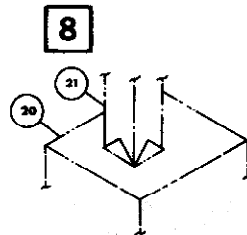
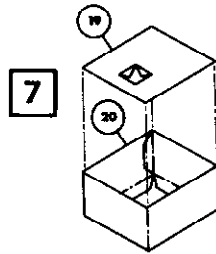
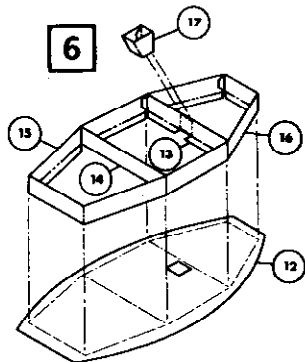
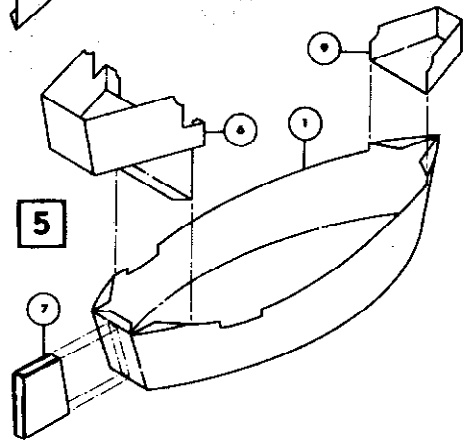
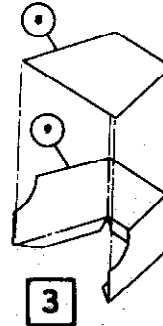
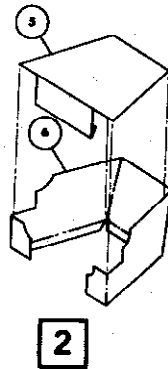
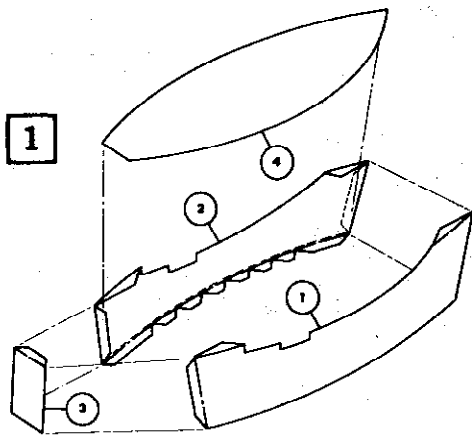

Dennis thoughtfully added a square grid sized for 25-mm figures over the upper and lower decks, as well as the quarter-deck, and poop deck. Each square is roughly 5' across, sufficient for most movement and combat purposes.

If you wish to add sails and rigging to the model, you would do well to consult the illustration of the cog on page 13 of this issue. The sail would be easy to add, requiring a yard arm of balsa wood or paper to hold it in place. String or thick thread will do as rigging. Be warned that the rigging may interfere with placement of miniature figures around the ship, but the sail should be out of the way.

Note that the ship was steered by a man in the pilothouse, who had only small notches through which he could see. A man on the forecastle called out instructions to him. The pilothouse was obviously made secure to keep the pilot from being killed in combat.

Dennis Kauth drew a few 25-mm shields, reproduced on the cut-out pages, for gamers who wish to hang them on the sides of the ship (as Vikings did with their shields on longships). Other shields and insignia, using decals, cut-out pictures, and the like, can be added to the ship as desired.

With a little imagination and a steady pair of scissors, a Dungeon Master should be able to create an adventure than all of his players will remember for years to come.

# Rogue Stones and Gemjumping

*Another of Elminster's little secrets*

by Ed Greenwood

"I've brought ye something," Elminster said. "But ye won't even see it if I don't have your solemn oath first that ye won't touch it — at *all* — or keep me from taking it away again. Dost hear?"

"Dost," I agreed, solemnly. "I agree to all those conditions and I can probably even muster up a few oaths, if you insist . . . any preferences? No, never mind . . . you've captured my attention with your not-very-subtle mysterious act, so tell me: Have you brought along someone's crown jewels, then? Or just the talisman of Asmodeus?"

"Do not jest about such things," the sage said, staring at me crossly. "Such irreverence for great learning. Tut, tut! I have indeed brought a jewel" — he produced a small, stoppered bottle of crystal, which he held up to the light — "as you can see. *This*" — he paused for dramatic effect; I spoiled it by handing him a glass of sherry, and turning on my tape recorder — "is a Rogue Stone!"

The stone Elminster showed me was small, about the size of a dime, faceted, and displaying a rainbow of shifting, fluid colors; pretty, even exquisite if properly displayed, but nothing to stand out when placed with other gemstones. These are very rare and not easy to identify, Elminster told me (and a search through my library failed to turn up anything of our Home Plane that matched them exactly), but there are over sixty known to exist in the Realms. None are known to have been turned up or mined; all have been found as cut, finished gemstones, and their precise origin is a mystery.

The name "Rogue Stone" is an example of that sense of humor prevalent amongst sages of the Realms — it is derived from the use of such gemstones by rogues: rogue magic users, to be more exact. By the use of a certain spell of great antiquity

(whose origin has been lost with time), it can be used as a means of precise transport from place to place, even from plane to plane (a process known as "gemjumping," or sometimes "gemwalking" or "gem-sending"). Only with this type of gem does the magic work. Due to their rarity, there is no set price for such stones, but Elminster tells me that he cannot believe a mage would knowingly part with one for less than a powerful magic item, much training, or the knowledge of a dozen or so spells. Here follows the necessary transportation spell:

## **Gemjump** (Alteration)

Level: 6

Range: 0

Duration: *Special*

Area of Effect: *Special*

Components: *V,S,M*

Casting Time: 2 rounds

Saving Throw: *None*

Explanation/Description: A very rare jewel, of the type known as a "rogue stone," is required as the material component. The spell-caster must hold this in one hand, and with the other one make the gestures required. At any time after casting is completed (even centuries later), the spell-caster (even in another incarnation, i.e., lichdom or after receiving a *reincarnation*) can, by an act of will, be transported to the location of the gem — regardless of the distance between the two, separation on different planes, or restraints upon the gem (in a setting or chest) or spell-caster (chains, bonds, imprisonment, paralyzation, petrification, and magical entrapments such as *force-cage*, *trap the soul*, *imprisonment*, *sink*). Transportation by means of this spell is instantaneous, and if the gem is in a confined area too small for the spell-caster's upright form to appear, he will appear in the nearest suitable open space instead. It

is a one-way trip; the spell-caster cannot later "jump back" to the first location by means of the gem.

The gem is not consumed in either spell-casting or transportation, and is not moved or affected in any way by the spell. Since transportation is by act of will, the spell-caster cannot be *feble-minded*, berserk or maniacally insane, sleeping, delirious, or unconscious. Casting a *gemjump* on a rogue stone does not negate or alter any previous *gemjumps* cast upon the stone (but not yet used for transportation) by others. Once cast, *gemjumps* cannot be dispelled by any magics worked upon the stone; only the utter (physical) destruction of the gem will do that.

Elminster recounted several famous uses of gemjumping in the Realms. I have set a few down briefly, as examples of the spell's multiple uses:

Glemmora, mage of Rallyhorn, escaped from manacles in the Dungeons of Torment after her capture by King Urgiathus of Dulgund, and appeared in the ruined city of Myth Drannor, where she had hidden her rogue stone and a spare spell book.

Gulthas, the Black Mage, fled from Avernus after an attempt to plunder Tiamat's hoard had failed, eluding three of her consorts, and returned safely to his seacoast citadel near Baldur's Gate.

Brammas, Lord of Sulmarin, regained his crown of office through the services of his mage-of-court, Durlyn, who had previously enspelled a rogue stone and affixed it in the gem-work of the crown — and used it to appear with the stolen crown in a cave not far from Sulmarin, where he defeated the thieves by magic, and preserved the crown.

Urthos "Greencloak" slew his mortal enemy, the mage Umpral, by jumping via a rogue stone into the latter's treasure vaults and taking him unawares.



Laeral, a famous mage, destroyed the demon lord Arlogolcheir with the aid of the archmage Khelben "Blackstaff" Arunsun and the mage Alduth of Neverwinter — when Laeral found the demon's amulet, she was wearing a belt containing two rogue stones, previously enspelled by Khelben and Alduth, and she called on the two by means of *sending* spells to aid her, so that all three were ready to battle the demon when it appeared.

The mage Faeros gained much magic when a rogue stone he had sold to an agent of the Red Wizards of Thay was conveyed to them and placed in their citadel; he appeared beside it, despite its imprisonment in an enspelled chest, plundered the spell books he found there, and escaped via a *fly* spell, pocketing the rogue stones. The Red Wizards are currently seeking him.

Khelben "Blackstaff" Arunsun is known to use a rogue stone as an infallible, safe return *teleport* when adventuring; it is kept in a secret room of his tower in Waterdeep and guarded in his absence by two apprentices who know not the details of its use.

Heladar of Procampur won a bride by sending a rogue stone as a gift to the princess Lustra, Royal Lady of Innarlith — and *gemjumping* into her boudoir one night, much to the distress of her handmaidens. He *slept* them all and had a long night of dalliance ere being discovered — time enough for him to fascinate the sheltered princess and win her affection. Thus he began an ardent and ultimately successful courtship.

The mage Mercloak of Ruathyn appeared from centuries of *imprisonment* beneath the earth and destroyed his jailer, the mage (by then, lich) Ranthal of Berdusk. A rogue stone enspelled by Mercloak had unwittingly been seized by Ranthal from Mercloak's treasury for use in Ranthal's diadem. It is said that after traveling about the Realms and finding them much changed since the time of his imprisonment, he returned to the site of Ranthal's destruction and thanked the absent mage for delivering him into a vastly better world while still young enough to enjoy its delights.

One note for all who find such gems: there is no known way of identifying the presence of extant *gemjump* spells cast upon a rogue stone, nor of determining the identity of the mages who cast them. Even a *wish* will not remove such magics. Elminster warns me that rogue stones may well be found here and not to go monkeying about with such things. I have assured him that DRAGON readers are far too sensible and prudent to unleash dire consequences upon themselves or their plane by keeping such stones. Besides, we have a foolproof way of losing unwanted items, forever — we just address them to ourselves and pop them into the mail. . . .



## OMNI's Choice

Supremacy is the board game where you lead a Superpower. Your objective is to conquer the world through economic, political and military strategy.

You make decisions that face the world leaders today. Should you sell oil or buy grain? Build armies and navies or launch laser stars? Your toughest decision will be — to nuke or not to nuke.

OMNI magazine chose Supremacy as one of the *Ten Best Games of 1985*. The editors of GAMES magazine chose Supremacy for the *Games 100*. This is the list of their 100, all-time favourite games.

**Supremacy Games Inc.**  
425 Statler Towers  
Buffalo, NY 14202

©Supremacy Games Inc. 1986

*"You can win in the traditional way by invading and conquering, or more subtly and shrewdly by buying or selling supplies of grain, oil, or minerals...you can try out various strategies long enough to make you eligible for a cabinet post."*

**Scot Morris** — Games Editor  
OMNI Magazine,  
December 1985

*"...the people at Supremacy Games have put together an exciting game with clear, simple rules and a minimum of luck. As with any game though, what you base your final judgment on is fun and Supremacy is definitely fun."*

**Ted A. McDonald**  
GAME NEWS,  
December 1985

*"...fascinating saga of economic development and military conquest... players will be experimenting with different strategies for many games."*

**Sid Sackson**  
GAMES Magazine,  
July 1985

Available at your local dealer —  
suggested retail  
price \$35.00

Omni Top 10  
Games 100

## WINTER FANTASY™ Convention '87

Come to Lake Geneva for a weekend of gaming pleasure!

**When:** January 3 & 4, 1987

**Where:** The Americana Resort in Lake Geneva, Wisconsin

**What's Happening:**

### Scheduled Guest of Honor

Jim Ward, Frank Mentzer,  
Penny Petticord, Tom Wham,  
Harold Johnson

### Special Events

RPGA™ Network Tournaments  
Axis & Allies Tournament  
Fortress America Tournament  
30mm Napoleonics  
25mm Circus Maximus  
15mm Ancients

### Featuring

Role Playing Games  
Miniature Events  
Boardgames  
Larger Dealer Area  
Saturday Night Auction  
Sunday TV Football Game

### Admission Costs

\$5.00 per Day  
\$8.00 for the Weekend  
\$8.00 Pre-registration\*\*

\*\*Pre-registration for the convention before December 15, 1986 guarantees the registrant a place at the Saturday morning 9:00 AD&D® RPGA™ tournament. Send check or money order (no cash please) made payable to "WINTER FANTASY Convention" at the address below.

Dealers are invited to write about table space and exclusivity.

For more information send a **SELF-ADDRESSED, STAMPED** envelope to:  
WINTER FANTASY Convention,  
Rt. 5, Box 18, Apt. 1, Lake Geneva, WI 53147.

WINTER FANTASY, AD&D, and RPGA are trademarks owned by TSR Inc.  
©1986 TSR Inc. All Rights Reserved.

ACCEPT NO IMITATION

# VILLAINS AND VIGILANTES™

A SUPER-HERO ROLE-PLAYING GAME

You can combat the forces of evil! You can become a champion of truth and an idol of millions! You can be a superhero and defend the human race against injustice and villainy! You can do all this as a character in VILLAINS AND VIGILANTES.

The rules deal with Superpowers, Combat, Secret Identities, Encounters, Character Creation and more! VILLAINS AND VIGILANTES comes as a boxed set with the rulebook, introductory adventure, character sheet, reference screen and dice for only \$12.00.

Rulebook Alone . . . . . \$6.00  
Introductory Adventure (Crisis at Crusader Citadel) . . \$5.00

Additional Adventures Available: ● Death Duel with the Destroyers (\$5) ● Island of Doctor Apocalypse (\$5) ● Opponents Unlimited (\$5) ● F.O.R.C.E. (\$5) ● Assassin (\$6) ● Most Wanted, Vol. 1 (\$5) ● Most Wanted, Vol. 3 (\$6) ● Dawn of DNA (\$5) ● From the Deeps of Space (\$5) ● Battle Above the Earth (\$5) ● To Tackle the T.O.T.E.M. (\$5) ● Devil's Domain (\$5) ● Pentacle Plot (\$5) ● Terror by Night (\$5) ● Organized Crimes (\$5) ● Pre-Emptive Strike (\$5) ● DNAgents Sourcebook is coming soon!

**SHATTERMAN:** An American military veteran and rock musician who uses his powers to continue to protect his country from the forces of crime and evil in general.

Identity: Jack Dunn      Age: 23  
Side: Good                      Level: 1

- Powers:
1. Heightened Endurance: +19
  2. Regeneration: Max, once per turn, takes one action, heals full healing rate.
  3. Invulnerability/20
  4. Flight: Max. airspeed = 279 mph, PR = 1/hr.
  5. Power-Blast: 20 inch range, PR = 1 per shot, does 1d20 damage.

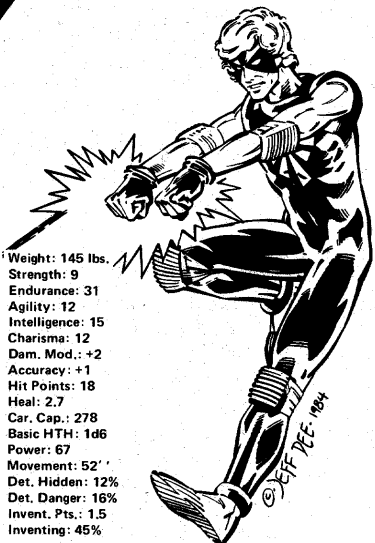

Weight: 145 lbs.  
Strength: 9  
Endurance: 31  
Agility: 12  
Intelligence: 15  
Charisma: 12  
Dam. Mod.: +2  
Accuracy: +1  
Hit Points: 18  
Heal: 2.7  
Car. Cap.: 278  
Basic HTH: 1d6  
Power: 67  
Movement: 52'  
Det. Hidden: 12%  
Det. Danger: 16%  
Invent. Pts.: 1.5  
Inventing: 45%

Available from better shops worldwide or direct from us at:  
P.O. Box 182, Roslyn, N.Y. 11576 (USA).

Please add \$2 for post and handling. NY residents please add sales tax.



## FORUM

(From page 36)

The spell which gives me the most problems tends to be *phantasmal force*. The DM doesn't know what limitations to put on the spell and we sometimes end up fighting over the spell.

The problems I have are:

1. Are creatures which have a low or animal intelligence affected by illusion?
2. When the *Player's Handbook* says that the illusion lasts until struck by an opponent, does that mean that he has to make a "to hit" roll or does it mean that the illusion touches the opponent?

3. What factors allow someone to make a saving throw? How would they know the illusion was fake?

I know other problems will arise with the use of more powerful illusions and with the use of different spells such as *audible glamor* and *spectral force*, and with spells dealing with *shadows*, etc. If it would help to illustrate how illusions function, could you give some examples of how these or other spells work?

I have never seen an article in DRAGON Magazine that deals solely with the problem of illusions. They are both difficult and confusing to attempt, and I think it would be well worth the time if you were to print an article dealing with this subject.

John Goldie  
Steamboat Springs, CO

## LETTERS

(From page 3)

seems to me that the AD&D game is becoming less popular and other games are becoming more popular. After all, there is only so much you can say about one game. Even in issue #49, when the game was still fresh, you had more on other games than you do now. I suggest that you become a gaming magazine instead of a role-playing magazine. Expand your computer articles for smaller computers, like the Atari XL series and the Commodore 64. Why not have an article devoted to 48LK Infocom games? Start printing more miniature articles. Expand into other types of games. This may sound totally absurd, but why not publish articles about Stratego, Risk, and even Monopoly. Maybe that last game was a mistake to mention. But the point is you need to diversify.

Kent B. Gravelle  
Oklahoma City, OK

I would call the Chainmail miniatures rules, with their fantasy supplement, the real father of role-playing games, but that's a moot point.

As noted in my last editorial, the majority of DRAGON Magazine's readership prefers a heavy emphasis on the AD&D game — but our readers like diversity, too. You'll find articles on the *ELFQUEST*®, *DOCTOR WHO*, and *TRAVELLER* games in this issue, for example. *TOP SECRET*®, *STAR FRONTIERS*®, *GAMMA WORLD*®, and *STAR TREK*®: The RPG game articles have graced our pages in recent months, and the *MARVEL SUPER HEROES*® game gets a good monthly shake. More articles on other fantasy, science-fiction, and super-powered hero games are forthcoming — but if you don't subscribe to the magazine, how will you know what we're running?

# BUSHIDO™

Flashing bladework, brave warriors, martial mastery, wise priests, honor, stealthy assassins, demons, magicians, spirits, war — the stuff of Legends, the Legends of Japan. BUSHIDO is a role playing game that allows you to adventure on the Misty Isles of Nippon.

Players in BUSHIDO design their characters to suit the profession they choose. A skill system is used to determine the character's success in both martial and peaceful endeavors.

Take a break from the Western European and sample the mysterious world of the Far East. Try adventuring in a world where a man's honor and fame are as important as the number of foemen he has slain.

Come follow the code of the Samurai, the Way of the Warrior. BUSHIDO!

BUSHIDO is available for \$18.00. Also available is THE VALLEY OF THE MISTS, a BUSHIDO adventure pack for \$5.00.

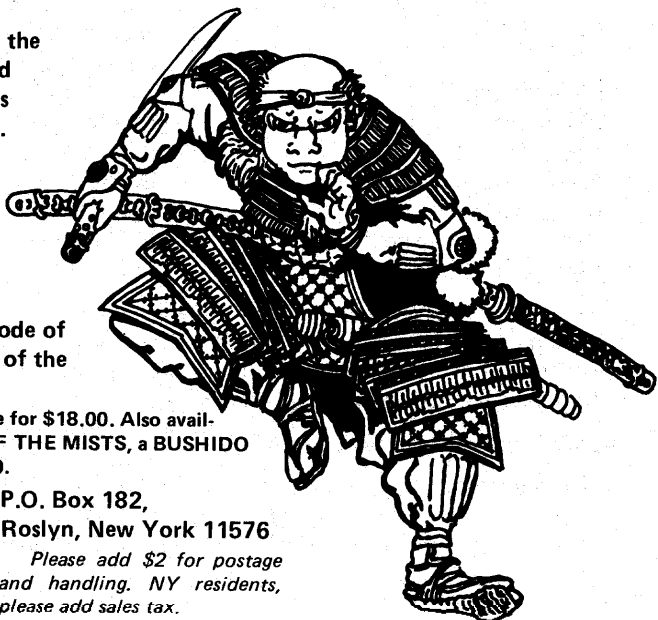

P.O. Box 182,  
Roslyn, New York 11576

Please add \$2 for postage and handling. NY residents, please add sales tax.



# DUNGEON™

ADVENTURES FOR TSR® ROLE-PLAYING GAMES

Bubba the Barbarian says:

# “LET’S PARTY.”

After a few weeks of wenching, carving mutton, swilling mead, and tossing halflings, I need a break. So I get out my war dinosaur Boo-Boo and visit a few exotic countries, get to know the locals and party a bit. Afterwards, I settle down with a copy of DUNGEON™ Adventures for the latest on local monster hoards and treasure troves.

DUNGEON™ Adventures. Now *that's* entertainment!



Please attach last mailing label if renewing subscription

SUBSCRIPTION RATES: *Second-class mail, one year (six issues) — Please check one:*

- \$18 in U.S. funds to the U.S. and Canada
- \$35 in U.S. funds by surface mail elsewhere
- \$52 in U.S. funds by air mail elsewhere



Method of payment:

- Check
- Money order
- MasterCard
- VISA

Card# \_\_\_\_\_

- New
- Renewal

Name of recipient \_\_\_\_\_

Mailing address \_\_\_\_\_ Apt. No. \_\_\_\_\_

City \_\_\_\_\_ State/Province \_\_\_\_\_ Postal code \_\_\_\_\_

For credit card orders only:

Name in which credit card is issued \_\_\_\_\_

Expiration date \_\_\_\_\_ Date of this order \_\_\_\_\_

For office use only

Authorized signature \_\_\_\_\_



# By Tooth and Claw

*Ordinary animals are dangerous in any game*

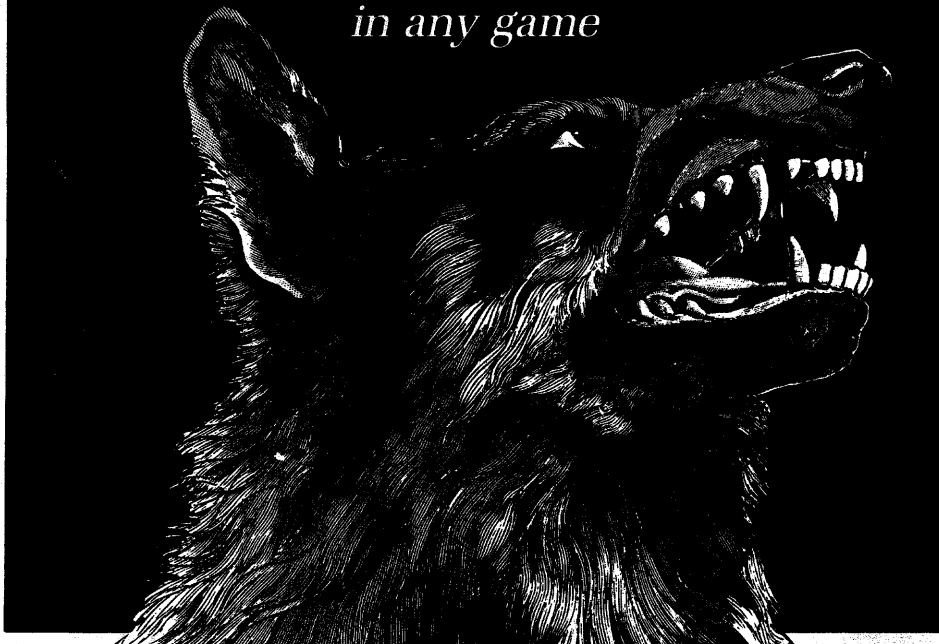

by Gregory Detwiler

Monsters: When one thinks of the word in AD&D® games, images of giants, dragons, owlbears, manticores, and chimeras come to mind. These are monsters; they're the big names — the famous supernatural beasts that send shivers down the spines of low-level characters. But lions; tigers, leopards, bears, and wolves? Hey, these are just ordinary animals. Anyone can handle *them*.

Wrong!

The purpose of this article is to demonstrate that ordinary animals are just as dangerous to player characters (PCs) as their imaginary counterparts. In fact, since most gamers think little of ordinary beasts, they are somewhat overconfident in these encounters. A canny referee can quite easily turn this overconfidence against the group.

To find out what type of damage dangerous animals are capable of doing, two "must read" books are of help: *Man is the Prey*, by James Clarke, and *Maneaters*, by Peter Hathaway Capstick. It is amazing how some animals are able to circumvent even the advantage of modern firearms;

similar tactics can also nullify the advantage of hard-hitting spells such as fireball. With a little inspiration from these books (and this article, of course), the DM can keep his tough, dragon-slaying characters on their collective toes — assuming they have any toes left.

Although the main thrust of this article is directed toward the AD&D game, the information herein can be used with equal facility in any other role-playing game. Most fantasy game monster listings include at least some mundane carnivores, as well as big herbivores like elephants and rhinoceri. The PALLADIUM ROLE-PLAYING GAME® has done especially well in this regard. Since ordinary animals act the same anywhere, the information can be used by players of the TOP SECRET®, MARVEL SUPER HEROES®, BOOT HILL® games, or by stranded space travelers and mutants from many science-fiction games. Some African beasts are even described in a recent module for the CALL OF CTHULHU® game. Being devoured by a lion may sound tame compared to being transformed into an amorphous slime of nethermost horror by an eldrich abomination, but the character dies just the same.

Before getting to specifics about individual animals, it might be wise to dispel a few general myths about wild beasts. The biggest myth is that fire drives away animals or holds them at bay. This is not always the case. A sufficiently hungry carnivore presses home its attack, fire or no fire, and irritable beasts such as hippos actually charge fires because of the way fire looks. In any event, a fire contributes no more to nighttime protection than enabling characters to see their attackers. Also, clerics and fighters have to take off their armor at night so they can sleep, making them a nice, soft AC 8 to 10 when attacked on short notice. A character can have plate mail and a large shield that are both + 5, but if he isn't using them when attacked, they might as well be nonexistent. There is some consolation for hack-and-slash PCs: the bright light of a fire ought to attract plenty of monstrous and mundane foes to fight.

Characters adventuring in forests or jungles often get the bright idea of spending the night in the trees, abandoning the horses (and possibly some hirelings) to the carnivores below. This is encouraged by the belief that lions and tigers can't climb trees. As a matter of fact, various witnesses claim to have seen both of these species climb 30' up smooth, branchless tree trunks. When adventuring in the wild, it might be better to take along a few sacks of caltrops instead of a book on how to build a tree house. The situation can be particularly acute in fantasy or science-fiction games; DMs might take their players completely by surprise by coming up with a wolf or grizzly bear that can climb — as they have both been known to do.

Finally, game-specific information on running wild beasts is often left up to the referee. A DM can create a particular percentage chance of a Cape buffalo breaking off a charge or of a leopard successfully tracking its prey, making it fit the game circumstances and mechanics as desired.

## Herbivores

Most people think that herbivorous animals are basically docile creatures. If you leave them alone, they'll go placidly about their business. Being a vegetarian or near-vegetarian doesn't insure a benevolent nature, however. A surprisingly large number of herbivores are rather high-strung, with tempers as brittle as egg shells; both camels and zebras have been known to bite off a man's arm. It pays not to take them for granted.

## Elephants

The largest of the herbivores, elephants have a variety of attacks available to them. They can spear human-sized opponents with their tusks, stomp them, or simply pick them up with their trunk and smash them against a tree. There is also a variant attack in which the elephant employs one

foot to pin a victim to the ground, then uses its trunk to tear him to pieces. One consolation on elephant attacks is that if a character is alone when relieved of this mortal coil, he may still receive a decent burial; elephants have been known to cover the bodies of their victims with branches, bushes, and the like. An elephant may do this even if in "must": a peculiar madness that comes on the males during the mating season.

There are often rumors and legends of man-eating elephants. In reality, only one elephant is known to have actually eaten a person. In 1944, a Zurich Zoo employee was so fond of tending to the Indian elephant there that she had special quarters made for her right by its cage. The elephant later killed and ate her (the creature was examined and found to contain the keeper's remains). In all other cases, the reports appear to be based on a habit some elephants have of carrying the body parts of victims around in their trunks or mouths, for no apparent reason. It's easy to see how the "man-eating" rumors got started. Of course, if the DM in a fantasy game wants to add a carnivorous elephant to his campaign, showing players ordinary beasts acting as mentioned above helps throw them off guard when the real thing comes along.

African elephants are generally thought of as more dangerous than their Indian counterparts, although the smaller Indian beasts can also be killers. If a DM's campaign takes place in India (or an India-type analog) at any time since the domestication of elephants, the following information might be of interest. Elephants in India are so scarce (compared to the human population) and are such valued workers that domesticated elephants who kill people are not destroyed. Instead, such an elephant is given a chance to calm down, if time permits in the work schedule. If not, someone else is assigned to replace the victim and things go on as usual. Since there are only a few thousand elephants in India, while the human population (and hence the pool of potential mahouts) is in the hundreds of millions, economic reality allows no other alternative. Any character who decides to hang around the party's elephant "where it's safest" could be in for a very rude awakening.

### Rhinoceri

Rhinos are more feared than elephants in many cases. They are duller-witted, touchier in general, and more prone to attack. In point of fact, rhinos are entirely unpredictable. The biggest killer is the African black rhinoceros — a creature to be avoided at all costs. Of course, characters may decide they have to hunt this creature for some reason. Just as elephants are hunted for ivory, rhinos are hunted for their horns, which are reputed to have a wide variety of medical uses (in a fantasy campaign, this might well be true).

Environmentalists won't care if a few rhinos are killed on paper; there are, however, a few things that should be discussed before risking the paper (albeit, highly valued) lives of favorite characters.

The biggest myth about the rhino is that one can escape its charge by standing still — then dodging out of the way at the last moment. Supposedly, the beast then continues charging in a straight line for a short distance until it decides to forfeit its attack. This supposition is quite mistaken. In spite of its great size, the black rhinoceros can turn on a dime. If irritated enough, the creature may well continue its vendetta until it has trampled or tossed something (men have been tossed 12' in the air by black rhinos). Rhinos can sometimes be distracted by tossing articles of worn clothing at them; homing in on the scent, the rhino quickly reduces a character's wardrobe by a factor of one. If a character is wearing a suit of armor, things are a bit more complicated. However, if a character is going to wear heavy armor, he should be ready, willing, and able to fight it out.

If a character decides to stand and fight, a tale told from the days of the slave trade gives an idea of the force generated by a charging rhino. Once, a black rhinoceros charged a line of 21 slaves who were bound together by neck collars and chains. The rhino headed directly into the midst of them and impaled the center man. The subsequent shock broke the necks of all 20 other slaves.

One final note on rhinos, for the benefit of any player whose character adventures in India (or in a region with similar fauna). Despite having a horn like all other rhinos, the Indian rhinoceros prefers to attack its foes by slashing them with its teeth. Backed by the rhino's massive strength, this biting attack does 2-8 hp damage in AD&D game terms. Thus, even a hornless rhino is not necessarily a harmless rhino.

### Cape buffalo

Nearly all types of cattle are capable of killing a man, but the only species with a regular history of doing so is the infamous Cape buffalo. Although dangerous, the Cape buffalo is not as overwhelmingly vicious as popular legend makes it out to be. The main reason for this is the buffalo's penchant for hiding in thick brush or forest when wounded, in the hopes that its pursuer passes by without noticing it. After a number of hunters accidentally blundered into wounded beasts, a legend grew up that the Cape buffalo, when wounded, would circle around and deliberately stalk the man who injured it. Except for the sake of storytelling, this is not the case. Unfortunately, this evil reputation has severely retarded progress in farming the buffalo as a breed of domestic cattle.

Like the rhinoceros, the Cape buffalo can toss a victim high in the air, and is

unlikely to be satisfied with a single toss. The Cape buffalo's charge is the hardest to dodge of any horned animal, because the creature keeps its eyes on the foe for the entire charge, lowering its head only at the last possible moment. Followers of the dodge-at-the-last-moment philosophy who haven't been killed by rhinos usually get it from buffalo instead. Since it is impossible to outrun a buffalo, the best course of action to take when encountering a charging herd is to stand perfectly still and wait patiently for the herd to pass. It may be that, rather than making an attack, the buffalo herd is merely charging upwind because it suspects something nasty is afoot. Buffalo also tend to go around unfamiliar objects. A lone buffalo, on the other hand, might be frightened off by a character who runs at it, screaming and waving his arms. Then again, it might stomp the character into the dust.

A major reason that a buffalo might attack is because the beast is wounded. This situation grew quite serious in Africa after traders started unloading inefficient, smoothbore muskets on the native tribes. In any modern game where the natives have such lousy guns, a DM should increase the chance of meeting wounded buffaloes (or anything else). Most large creatures can absorb an incredible amount of lead before falling, if they aren't hit correctly. On one occasion, two hunters pumped over a dozen shots into a Cape buffalo before it fell over. After that, one hunter placed his foot upon the beast while posing for a picture in the time-honored fashion. As soon as the man did so, the beast lurched to its feet, knocked him down, and killed him before it finally dropped dead. Any character who wants to go trophy hunting should use extreme caution when recording his kills for posterity.

### Hippopotomi

The hippopotamus (as well as its larger AD&D game relative, the behemoth) is an extremely irritable creature. It is famous for charging anything that irritates it, from groups of people to campfires. This creature's massive jaws can literally bite a person in half — something it does with surprising regularity. As late as the 1960s, at least 200 people in Africa were killed every year by hippos.

Since the hippo is an aquatic beast, most discussions of this creature center on its interesting preoccupation with flipping over boats and canoes. Granted, this is a good way of making things interesting for a waterborne expedition, but the hippo is just as dangerous on land as it is in the water. Hippos like to graze on the land (especially at night) and tend to get in a rut when traveling, using the same path over and over again. They dislike having their way blocked, and if the offending creature is crunchable, it gets crunched. Characters in full armor might be able to handle this creature, but hippos live in water; thus,

the surrounding territory is likely to be swampy or extremely muddy, with a good chance of quicksand (just the thing for a character in full plate armor).

## Carnivores

Everyone's favorite animal villains are the carnivores. Despite what is often heard or read, a good many man-eating animals are *not* aged, injured, diseased, or otherwise incapable of catching their natural prey. In fact, they often look better than ordinary members of their species, with softer, glossier coats.

Most man-eaters get started by killing a person in self-defense, thus finding out how easy people are to kill. Some man-eaters kill several people before they actually taste the flesh and decide that they like it. Certain animals are more prone to this than others. Professional hunter Peter Capstick mentions a number of carnivores he calls "natural" man-eaters; this doesn't mean that some creatures naturally prey only on humans, but that they are casual man-eaters, eating humans along with other animals — for example, in the manner of a lion eating zebras one day and wildebeests the next. Capstick's "naturals" are leopards, hyenas, crocodiles, and sharks. In the case of the leopard, the naturalness is enhanced by its hunger for other primates (monkeys and apes).

Another good reason for taking up man-eating is the availability of easy prey, with little or no risk involved. Whenever there are a large number of human corpses around, the local carnivores have a free feast and an excellent opportunity to turn into man-eaters. This circumstance is especially useful in *Oriental Adventures*, with its listings of events such as war, bandit activity, earthquakes, floods, incursions major and minor, and plagues. Every time an event creates piles of bodies which are scattered around, there should be at least a 50% chance of man-eating activity following. Some districts may suffer waves of man-eating activity from different generations of carnivores, if conditions are right. In the days of the slave trade, for example, those natives who were the weakest were most often left behind. Being the least able to defend themselves, they were easy prey for carnivores who had no fear of pursuit by able-bodied hunters. Similarly, a much-used battlefield or a dumping-ground of dead bodies is a man-eater training ground.

There is no question that man-eaters can be a serious menace. It is particularly surprising that all carnivores are not man-eaters. After all, throughout most of history, most people did not have weapons capable of killing large carnivores in one-on-one fights. This weakness of weaponry is exacerbated by the fact that in a physical fight with natural weapons, humans are far outmatched by carnivores, such as lions, tigers, and bears. This is clearly

shown in many games; in the AD&D game, the big predators have the added advantage of more hit points. Whereas the average human has 6 hp or less, wolves have 2 + 2 HD, leopards have 3 + 2, and lions have 5 + 2. As you can see from these examples, even if a peasant fighter was able to inflict the same damage as he received, the animal would win through sheer attrition of hit points. Remember that this article is about ordinary animals and not mythological monsters. The average person is easy prey for big carnivores — in games or in real life.

Lack of natural prey is a common explanation for man-eating. The main theory as to why all big predators are not man-eaters is that men are scarce in the areas where the big carnivores are most common. The flesh-eaters would naturally prefer to prey on the more common game animals, which are generally a more reliable source of food. And, from the animal's point of view, why not eat people if it is possible to survive on a diet of human flesh? Instead of being surprised that an animal would dare to eat people, we should be surprised that more of them don't.

Because carnivores are "professional" hunters, they are a more serious threat to adventuring parties. Rather than taking on the entire party at once, they would rather pick off one person at a time for food, preferably when the victim is alone or asleep. If caught in the act, the creature chooses the better part of valor and flees, possibly to return when things are quiet. A pack of carnivores (or one big one) could easily keep a party up all night in this manner. Consequently, mundane carnivores are ideal creatures for wandering monster charts; they are relatively more common than dragons, and they don't hoard mountains of treasure, thus reducing the risk of an imbalance in the game. Carnivores can harm a party of adventurers in other ways as well, such as killing or scaring off horses, henchmen, and guides, or stealing food supplies.

### Bears

The largest-known land carnivores today, bears can be major menaces. The biggest and most dangerous bears, the Kodiak and polar, don't actually kill that many people (of course, being restricted to a few islands, the Kodiak doesn't get many opportunities). The grizzly bear has a well-deserved reputation of being vicious in battle, but not-so-well-deserved reputation for unprovoked attacks. Grizzlies rarely attack without provocation, but — as a hunter once remarked — the bear is the one who decides what provocation is.

The smaller bears do as much or more damage than the big ones. The relatively small American black bear can and does kill people; there are seven recorded instances in which people were apparently killed for food. Oddly enough, in every

case, the region had a bad harvest of berries that season. On one occasion, a black bear killed a lumberjack and stayed with the body even after being jabbed with a hook and having a five-pound can of lard bounced off its head. It was finally driven off by inaccurate rifle fire after equally inaccurate revolver fire failed to frighten it. Surprisingly enough, the bear that kills the most people is the even smaller sloth bear of India and Sri Lanka. A highly irritable beast, this creature has killed more people than even the grizzly.

As the largest land carnivores, bears are appropriately powerful. Grizzly bears have often killed cattle for food, dragging full-grown steers a mile or more. Their capacity to absorb lead is also amazing. The Lewis and Clark expedition used up almost a dozen rounds of ammunition in order to kill the first grizzly encountered; the bear was finally slain by a shot in the head before it killed several members of the expedition. This information should be greatly appreciated by BOOT HILL game players, as grizzlies were relatively common in the Old West. One bit of advice is helpful: Don't waste pistol ammunition on a bear unless you can fill its head with relatively large-caliber revolver bullets. If a character plans on using a derringer on any part of the bear, the only thing that can be said is DON'T. Fire in the air to scare it, but don't hit it. A character would be better off using a knife in this situation; at least the knife won't run out of ammunition.

### Wolves

The wolf is one of the most famous and most controversial of the large predators; its man-eating record is quite odd. In Europe and Asia, the wolf is a confirmed man-killer, while in North America there has never been a single case of a man-eating wolf, and almost no cases of killings or attacks in general. There seems to be no good explanation, except for the fact that North America kept its large game population for far longer than Europe did. As the following shows, North Americans are lucky to have missed killer wolves.

The largest recorded death toll by wolves was run up by the Beast (or Beasts) of Gevaudan, France. Accounts vary as to whether one or two wolves were involved; the death toll makes it seem likely that there were two. Operating from 1764-65, it (or they) killed 60 people, mostly women and children. There were also a number of failed attacks, including attacks on herders in which the victim's own cattle grouped together to chase the wolf off. These wolves were massive beasts of a reddish-brown color. When it was all over, a king's physician examined one and thought it more like a hyena (unknown in Europe since prehistoric times) than a wolf. The wolves eluded innumerable posses, professional hunters, and army troops before finally being hunted down.



Depending upon the version of the final report chosen, the death toll comes to either 30 or 60 people killed per wolf.

Wolves are incredibly cunning on the hunt. Cases have been cited in which wolves have attacked farmhouses after the men had left (often to join wolf hunts), slaying women and children. Wolves are quite good at dodging hunters and avoiding traps; even in the 1950s and 1960s, there were reports of wolves killing and eating people in Spain, Portugal, Italy, Turkey, Syria, Finland, and Russia, among other places. Even soldiers were killed in some instances: an Italian soldier in the 1950s, and two Finnish soldiers in the mid-1940s. After the latter killings, the Finnish army launched a massive wolf hunt involving airplanes, machine guns, and land mines; they killed only two wolves.

Pilovo, Siberia, December 1927: With all the game gone, the wolves of the region closed in on one small town. First, the watchdogs were killed and eaten, then almost half a dozen men who tried to leave the village. After this, the wolves entered Pilovo en masse; hundreds of them roamed the streets, entering the stables and killing all the horses. After the horses were gone, the bigger wolves flung themselves at the doors of homes, breaking them down. A Soviet reconnaissance plane finally discovered what was going on, but by the time army troops arrived, nearly every family in Pilovo had suffered at least one casualty. Earlier, in 1914, a caravan in the Urals was annihilated by large packs of wolves. The wolf's uncanny intelligence seemed to be at work here, as the wolves picked off all the gun-toting men (who were reduced to fighting with rifle butts at the end) before starting in on the women, children, and livestock.

A final example of what a determined wolf pack is capable of doing may be cited. In France, 1447, a pack of wolves led by a large brute (called Courtaud by the local population) started killing livestock and people in the suburbs of Paris that fall. In the course of the winter, the wolves actually managed to enter the walled city itself, killing over 40 people before being wiped out in front of Notre Dame Cathedral. With this type of resourcefulness and determination, even bigger cities are not entirely safe from wolf attacks.

## Hyenas

One of Capstick's "natural" man-eaters, the hyena is possibly the world's most underestimated predator. Since a large part of this creature's diet comes from scavenging, the hyena is assumed to be a cowardly creature. This is not the case. Hyenas can and frequently do hunt down and kill their own prey, banding together in packs to attack antelopes and other herd animals. In fact, they are often so successful that lions often follow the hyenas to scavenge from *their* leavings.

The hyena's power and size (male hyenas sometimes get as large as 150 pounds)

is frequently underestimated. Since the hyena is a scavenger, it naturally stands to reason that its jaws are powerful enough to crush bones. This assumption is correct. Hyenas bite anything they can get their teeth into.

The power of a hyena's jaws is best illustrated when it engages in its favorite pastime of raiding camps. Anything made of leather or animal hide is in imminent peril of being eaten, and the smell of blood or food can endanger anything. Metal cans have been bitten open in order to get at the contents, and African tribesmen who delayed cleaning their weapons after a hunt often found their iron-bladed spears chewed into uselessness; Even cooking pots have been carried off. Any dressed game or carcasses hanging out are prime targets for hyena attacks.

Man-eating hyenas often attack when the victims are asleep outdoors (one pack in the 1950s is reputed to have killed 60 people). Like other man-eaters, hyenas completely devour their victims — bad news for AD&D game players who are unafraid of death due to clerical resurrection. Both *raise dead* and *resurrection* require an intact body; if the body is eaten (and man-eaters always eat the body immediately after a kill), the victim is gone forever unless his comrades can lay their hands on a *wish*.

Hyenas also have an annoying habit of "taste-testing" sleeping victims. Instead of eating the whole person, they simply bite off a mouthful or so and run off into the night. While any part of a person's body is at risk, the favorite target is the area of the face just under the eyes.

If a character wants to fight it out with one or more hyenas, here's a final anecdote relating the creature's strength. A band of big game hunters in Africa killed an antelope and split the carcass in half. While they were putting half of it in their Land Rover, a hyena charged the remaining carcass, picked it up in its jaws (all 40 pounds of it) without slowing down, and ran off into the night with its head held high. The carcass was carried entirely above the ground. Doubtless, a similar grab could be conducted against a lightly armored halfling or gnome.

## Lions

The lion is one of the most famous man-eaters, though as a species it is not nearly as enthusiastic as the hyena or the crocodile. When a lion turns man-eater, though, it can do an incredible amount of damage — especially in an area where the people are poorly equipped. It has been calculated that a truly dedicated man-eating lion (i.e., one that lives exclusively on human flesh) must eat a minimum of 50 adult humans a year to stay alive (150 a year if it wants to stay in peak condition). Some lions do, indeed, stay healthy on such a diet. In the Njombe area of East Africa, a pride of 15 to 20 lions terrorized the area

for nearly 20 years, killing 1,500 to 2,000 people — an average of 100 kills per lion. If a fantasy frontier region had beasts like these for its lion population, land-owning player characters might find their dominions ruined — not by wizards, orcs, or dragons, but by ordinary animals.

Lions are capable of some extraordinary physical feats. Their ability to climb trees (popular legend notwithstanding) has already been mentioned. A full-grown male has the strength of 10 average men, which is obviously useful when pouncing on and killing antelopes and zebras. In one instance, a lion was seen jumping over a 12' chasm from a standing start; some have been known to leap as far as 36'. Although it is true that lionesses do much of the pride's hunting, the big male does his own stalking and killing whenever necessary. With talents like these, merely surrounding one's camp with caltrops or tripwire fences is grossly inadequate. One lion is capable of dragging off anyone from a well-guarded camp. If the pride joins in, the campaign is over.

Like other predators, lions have more intelligence than they are given credit for. A common man-eater tactic, one particularly common in the Njombe killings, is for the pride to constantly roam the hunting grounds, leaving a neighborhood immediately after finishing a kill. Thus, the second victim of the pride could be killed just after hearing of the untimely demise of the first victim a hundred miles away. This obviously makes setting traps useless; where should they be set when it isn't known where the intended victims are going to be? Player characters who hunt man-eating lions (or other man-eating cats) should be given a run for their money.

Lions are quite common in worlds or historical periods with no high-powered rifles. In ancient times, they lived all over Africa and Asia (there are still a few hundred left in India). At one time, they also roamed over Southern Europe, until they and their brethren in North Africa and Mesopotamia were wiped out by the Romans, who expended them in gladiatorial contests. Mark Anthony even used tame lions to draw a chariot. A version of the cave lion, *Felis atrox*, even lived in Ice Age North America until the Paleoindians wiped it out. (As another indication of lion intelligence, at Rancho La Brea, over thirty *Smilodon* (sabre-toothed tiger) skeletons were found in the tar pits for every single cave lion.) To top it off, cryptozoologists (scholars who hunt for creatures like Bigfoot and the Loch Ness Monster) claim that frequent lion reports in the U.S.A. indicate that *Felis atrox* may still be hiding out in the wilder portions of the country.

Treating lions like intelligent PCs or NPCs is not necessarily a bad idea. In one African story, the head native tracker in a lion hunt wrangled some time off to get married. In a strange example of patience and cunning, the lion being chased silently followed the tracker home, hid during the

wedding, and hauled him off to dinner on his honeymoon night. The act was performed so quietly that the bride never once woke up; only when she arose in the morning and saw blood on her husband's pillow did anyone realize what had happened. Incidentally, in games in which damage is listed for various parts of the body, a lion can kill a sleeping man by sinking its thumb-thick fangs through the skull.

In one respect, lions are much more dangerous than any other big cat: they have the advantage of numbers. Only lions are social cats, and a pride could have as many as a dozen members or more. Since the *Monster Manual* gives a grown lion 5 + 2 HD, it is easy to see how a full pride could be a reasonable challenge for mid- to high-level PCs. Even high-level characters may find lions to be a major threat — especially if they are attacked at night when the fighters don't have their magic armor on, and the archmages haven't memorized their offensive or defensive spells. If the other cats (especially the larger tigers) were social, they would be much more formidable creatures. In science-fiction or fantasy games, the referee can tamper with the laws of nature, making this possibility become fact.

As a side note to lion-related subjects, it should be mentioned that African witch doctors use a form of magic called *Mbojo* (actually a type of drug treatment) to create what the locals believe to be beast people or lycanthropes. These victims, the *watu Simba*, are drugged, dressed in animal (typically lion) skins, outfitted with weapons or steel claws, and hypnotically ordered to murder victims at the witch doctor's command. Since the victims are drugged, their actions and behavior are similar to that of zombies. In the AD&D game, PCs may actually believe them to be regular undead zombies, which could cause a waste of holy water and anti-undead spells. It might be a good idea to have *watu Simba* soldiers on the outer perimeter of any location with *real* undead in the main line of defense. The *watu Simba* fight as zombies (i.e., poorly), but if the PCs hurl all their holy water and otherwise weaken themselves, it could even the odds for the final showdown.

## Tigers

The largest of all the great cats currently alive, the tiger naturally requires the most food. A dedicated man-eater must consume at least 60 human adults to meet its minimum yearly requirements, while good condition requires 180. Some tigers achieve even these extreme goals. The most infamous, the Champawat tigress, killed 436 people before being slain. Though not all tigers are man-eaters, enough of them have turned killer to run up a very bloody record. It is estimated that in the past 400 years, tigers have eaten a minimum of 500,000 people in

India, and a million in all of Asia. To accomplish this, 300-800 man-eaters must have operated at any one time in this period. For one example, in late 19th century Singapore, 600-800 people were killed each year by tigers, and 15 men were killed there in 1929. In India in the late 1940s, 800 people a year were killed by tigers; as late as the 1960s it was still at least 50 a year.

As befits the largest cat, the tiger is also the strongest. One killed a 1,700-pound gaur (a type of wild cattle), moved it 15 yards, then was chased from the kill. Afterwards, 13 men were unable to move the carcass as much as one yard. Tigers have easily cleared fences 8' high by jumping, and, when hunted by mounted men, they have adopted the unsettling habit of leaping to the elephant's back and mauling the riders. Sometimes the leap is made with such force that the howdah is knocked off the elephant's back. As a result, hunters of a hundred years ago developed large-caliber pistols, called howdah pistols, to meet this contingency. What a party of D&D® or AD&D game players would do is not so easy to say, but using *fireball* at such close quarters would be problematic.

The tiger is another adaptable predator. It was once found all over Asia, from the snowy steppes of Siberia to the steaming jungles of Indochina and India. Tigers have been known to roam as far west as Mesopotamia and the southern provinces of the Soviet Union, and fossil finds seem to indicate that they once lived in Africa. Despite the name, the sabre-toothed tiger was a separate species from tigers, so its existence in Europe and the Americas should not be taken as evidence of the wide-ranging habitat of the tiger family.

Tigers are hard to stalk, despite their bulk. Aside from the fact that their stripes provide near-perfect camouflage, they have a quirky habit that they share only with jaguars in the big-cat line: they are excellent swimmers. In fact, tigers have often been known to swim out to fishing boats and other shallow-water craft to get at the people on board. Also, as said at the beginning of this article, tigers climb trees. Like most other big cats, tigers give hunters plenty of trouble, but for sheer ability at concealing themselves and living near a human community undetected, tigers take a back seat to leopards.

## Leopards

A relatively small cat, the leopard is surprisingly powerful for its size. On two observed occasions, leopards have climbed 30' up a tree with a 90-pound antelope, and 12' with a 200-pound baby giraffe. Grown men have been carried 1-4 miles before being eaten, though this is an infrequent event. Although a "natural" man-eater, leopards prefer to concentrate on smaller prey, such as women and children. Aside from being all black instead of spotted, the black panther is the same animal

as the leopard in all respects.

Veteran hunters often came to hate the leopard for its "cowardly" behavior, meaning that the leopard would not walk out in the open to be shot. Besides having the advantage of small size, the leopard is highly intelligent. When any great cat makes a kill, a standard tactic of human hunters is to set up a tree blind nearby and wait until the beast comes back for seconds. With this tactic becoming more and more frequent, some leopards picked up the habit of circling around when returning to the kill, and using their perfect night vision to stalk the hunter lying in wait.

As illustrated above, if a leopard decided to become a full-time man-eater, it could cause a great deal of trouble in the neighborhood. The two most infamous man-eaters are the Rudraprayag leopard, which killed 125 people, and the Panar leopard, which killed an estimated 400 people in the course of its career (it is suspected that many other victims were killed, but their deaths were unreported due to the remote areas involved). As with all man-eaters, it behooves would-be hunters to kill the creature quickly, ending its career before it picks up new tactics of evasion.

As an example of the nervous tension that can be generated in a leopard hunt, veteran hunter Jim Corbett (who slew the Panar leopard and other assorted man-eaters) twice suffered nervous breakdowns in the course of hunting man-eating leopards. The canny leopards often managed to come as close to the hunter as 2-4', always keeping an intervening object between them and Corbett so as to deny him a decent shot. The implications for AD&D game players are obvious: the same tactics also deny magic-users many opportunities to kill the beast with long-range magic. Any magic-user employing a spell like *fireball* at a range of 2' would be more of a threat to the party than to any leopard. Also, if the cat springs into the midst of the party, a great deal of pushing, shoving, and bumping immediately occurs — ideal conditions for causing spell-casters to lose concentration (and their spells). Fighters must do all the dirty work, assuming the leopard is willing to fight to the death and not run away after an initial attack. Playing hide-and-seek in the thick jungle can wear out any party.

The leopard lives in both Africa and Asia, and has adapted itself to all terrain features: plains, jungle, forest, mountains, deserts, and ice fields. It also existed in southern Europe until Roman times (animal collection teams supplying the coliseums were very busy). When the DM is creating a new world and supplying it with wildlife, he should take this adaptability into consideration. Leopards have even been captured prowling the suburbs of major cities, and are frequent scavengers around small towns and villages, although they are rarely (if ever) seen.

## Other cats

The other members of the cat family are usually too small to kill people. The cheetah is large enough to do so (hence its vital statistics in *Monster Manual II*) although this creature has never been known to attack a man. The only regular big cats left, the jaguar and the puma, have killed people, but only rarely as food. They *do*, however, follow people, out of curiosity; naturally, if the person realizes he is being followed, he probably assumes it is out of hunger rather than out of curiosity.

The puma may be nothing more than an overgrown pussycat, as it has a reputation of being more cowardly than any other cat of its size. The jaguar, however, is something else again. The third largest of the big cats, it is so powerful that it regularly kills cattle by biting into (and through) the skulls. It has a nasty reputation to match. Though there are few documented attacks on man, many may have gone unrecorded. From the standpoint of common sense, there seems to be no good reason why there are no proven cases of man-eating jaguars. The other big cats have plenty of big game in their habitats; Africa has the largest selection of prey in the world, while Asia has plenty, though with less variety. Even North America has good-sized deer, elk, and pronghorns. In the jungles of Latin America, however, the largest prey are the pig-sized tapirs and capybaras. Jaguars rarely go into the mountain homes of llamas, vicunas, and alpacas, and on the pampas they have little chance of catching the fleet guanacos and ostrichlike rheas. So with such a paucity of natural prey, it seems only natural that the jaguars would prey on man. The aforementioned theory of human scarcity seems to be the only restriction.

In Australia, there are occasional reports of large, unidentifiable striped cats preying on cattle and sheep. So far, nothing is proven, but a marsupial tiger is certainly one possibility. Since the animal is so rare (assuming there is one), no attempt is made herein to assign statistics for play to it. If a gamemaster wants to use such a creature in his campaign, he may think of it as a regular tiger with a pouch for its young.

## Wolverines

The wolverine, nicknamed "the glutton" by inhabitants of the northern regions, is an animal that is a nuisance out of proportion to its size. The giant version, of course, rates as a fourth-level monster in the AD&D game, but the regular wolverine can cause trouble for a party as well. Although this creature probably won't attack a grown human, no assurance of safety is given to dwarves, gnomes, and halflings. If attacked first, say for the sake of its fine fur, a wolverine could inflict potentially fatal damage on its assailant. As evidence of this, 30-pound adult wolverines have defeated full-grown bears and pumas, driving them from their dens.

However, direct combat is not the only way in which a wolverine can harm a party.

One habit the wolverine has that makes it an annoying neighbor is its practice of following trappers on their rounds or otherwise hunting out traps, then stealing the carcasses of any animals that were caught. Wolverines have also been known to break into cabins to plunder stocks of food. What wolverines don't eat, they ruin, and that goes for inedible items in the cabin as well. Thus, if some PCs decide to hole up for the winter in a cabin in the woods, they could find themselves with more trouble than they can handle.

Much has been made in recent years of the challenge of characters adventuring in the wilderness without sufficient supplies. While this can make an intriguing adventure, it can be hard to arrange. If characters can afford it, they may buy adequate stocks of supplies for outdoor adventuring. If a DM wants to force them into the great outdoors, he must ruin or steal supplies after the PCs get it. How better to do it than to have a wolverine break into the cabin while everyone's outside — possibly after discovering that the wolverine has already robbed all their traps? With no food, the characters must take to the woods, hoping to find game — but they are more than likely to find starving predators looking for the same (or perhaps a bear who was displaced from his cave by the very wolverine that started this mess). If half the party freezes to death outside while the other half is eaten by starving wolves, it is doubtful the players will consider the wolverine nothing more than a nuisance.

## Crocodiles

The crocodile is another of the "natural" man-eaters, and very likely the most successful. There is a record of one crocodile living in the Kihange River in central Africa which ran up a score of 400 victims. Another on the Zambesi River killed 300. The killers were both Nile crocodiles, which have the best opportunity for killing humans. In the 1930s and 1940s, nearly 4,000 people a year were killed by Nile crocodiles in Africa; the toll was roughly 1,000 a year in the 1960s, and several hundred people are still killed each year by crocodiles in Africa today. The "mugger" crocodile of India is no longer a threat, though that species claimed 250 victims a year into the 1930s.

The crocodiles listed above rarely get beyond 20' in length. The salt water, or estuarine, crocodile of the Indian Ocean region, however, is something else altogether. This monster regularly grows to a length of 30', and 40' specimens have been recorded. As a number of books show, this is the species that wiped out 500 Japanese troops on Peleau Island in 1943, after U.S. forces drove them into the swamps. A larger toll came in 1945, on an island off the Burmese coast. The British surrounded

a thousand Japanese troops there and forced their retreat into the swamps. After a night filled with screams and roars, twenty demoralized survivors staggered out to surrender. It is also believed that one or more of these creatures ate David Rockefeller in New Guinea. The estuarine crocodile doesn't have the same opportunities for catching human prey as its African relatives; still, it does the best that it can.

No matter what species, the crocodile is a clever, powerful predator. Nile crocodiles have been known to drag down full-grown lionesses, rhinos, and Cape buffalos, although catches like these are rare. They mostly live on predatory catfish, which in turn live on the same fish people eat, which makes the crocodile something of a major asset. Unfortunately, the crocodile eats anything it can catch, including livestock coming down to the river for a drink and native women filling their water jugs. The crocodile elaborately stalks its landbound prey, showing an intelligence one would not suspect in a reptile.

A crocodile's hunting skill extends beyond its aquatic habitat. For short distances, crocodiles can outrun men; one is recorded as having snatched an antelope 10 yards away from the water before it could flee. The crocodile in question ran from the water, raced up to attack, and raced back with its prey in a matter of seconds. Although it is physically impossible for a waterbound crocodile to knock down landbound prey with its tail, one tail swipe can break a leg if the victim is on the same level.

Crocodiles are a deadly menace, no matter what game is being played. In the TOP SECRET game, for example, the weapons secret agents most commonly carry are light caliber pistols or submachine guns. These weapons have little or no chance of penetrating a crocodile's thick hide. Nothing smaller than a .45 caliber weapon should be used in this event (even at close range), and it requires a magnum-type pistol to cause any worthwhile damage.

Once a crocodile gets hold of its prey, it drags the victim underwater to drown. Crocodiles are quite patient during this process, so feigning death is useless in making the creature let go prematurely. After the victim dies, the crocodile tears it into bite-size chunks. Often, the carcass is left to rot, making the process of tearing easier. When a swarm of crocodiles are around, they take turns tearing off pieces of meat, though it might mean that none gets a full meal if enough diners are around.

As is fitting for such efficient killing machines, crocodiles are widespread; there are species all over Africa and tropical Asia. They exist throughout the tropical portions of Latin America and in the mangrove swamps of the southern tip of Florida (don't confuse them with the more common alligators in the rest of the state). There are even crocodiles in Australia,



though there are few if any records of them killing people. The salt water crocodiles are found throughout the Indian Ocean region, and can be found at sea in Indonesia and the Philippines, and countless other islands, including New Guinea. Until the Ice Age, crocodiles even lived in the warmer parts of Europe.

### Killer whales

The killer whale is one of the deadliest predators in the sea. Although a good deal of folklore has been accumulated concerning its man-eating habits, there is no documented case of a deliberate attack on man. This is not to say that the killer whale has never eaten anyone; there's just no written proof.

Although it lives mostly on fish, the killer whale also consumes a great number of dolphins, porpoises, whales, seals, walrus, and penguins, making it the only cetacean to eat warm-blooded animals. As has been noted a number of times, killer whales rise to the surface suddenly and break through the surface ice to see if any prey is available; if prey is present, smaller ice floes are rammed and shattered to force animals on them into the water. Large whales are attacked by "wolf-packs," which take turns lunging at their prey and tearing off chunks of flesh and blubber. Baleen whales are favored, as they have no real teeth with which to fight. Killer whales are quite voracious; although it may take a whole herd to wipe out a high-level adventuring party, it takes only one to devour it. A 30' killer whale was once found with 13 porpoises and 14 seals in its stomach (it choked to death on seal #15). A grown man could be entirely swallowed in the same manner, which is one reason not to put faith in the "no attacks recorded" account.

### Other fish of prey

So much has been written about sharks, barracudas, and piranhas that they have been grouped together into one category herein. There's really not too much to be said about these fish that can't be found in any decent book on the subject. Everyone knows about the "feeding frenzy" — that mad wave of biting that follows the scent of blood. However, it may not be known that recent studies have shown that some sharks, when initially circling their prey before an attack, can be driven off if the intended victim takes the offensive against them. Apparently, sharks are so accustomed to the role of predator that any turning of the tables is too much for them to take.

One shark which is not as well known as the tiger, great white, mako, etc., is the main man-killer. This is the bull shark, also known in some African regions as the Lake Nicaragua shark, the Zambesi shark, and the Genges shark. This shark, like only a few other fish, can survive in both fresh and salt water. If a bull shark hunting off the coast of Louisiana decides to

swim up the Mississippi River to sample the cuisine of Arkansas or Missouri, there is no reason why it cannot.

It is worthwhile to end this discussion on sharks with a few words of warning. Characters in games such as the TOP SECRET game may be equipped with shark repellent. This compound does *NOT* harm sharks; at most, it makes them reluctant to enter the area of colored water. Tests conducted by the U.S. Navy after World War II showed that blindfolded sharks swim through the repellent cloud without knowing it was there. A character is better off following the standard warnings: don't spear fish or otherwise cause blood to be shed underwater (many DMs cause large schools of sharks to show up shortly after an underwater battle), don't wear anything shiny, don't move around a lot when sharks are around (not only the sight of movement, but also the water vibrations attract them), and leave as soon as possible when sharks *do* turn up. It's also a good idea never to dive alone; if a shark attacks, there is always hope that it may go after the other guy(s).

The above warnings also apply to barracudas. Despite their ferocious appearance, barracudas do not attack humans when they see what they're up against. The swift barracuda preys on small, fast fish, and does not like to tackle something it can't devour all at once. Most barracuda attacks, however, take place at night or in murky water. The fish sees an arm or leg moving and bites it, not realizing that it is part of a much larger creature. Referees should take this into account when adventures take place under these conditions. Although barracudas are dangerous and unpredictable, they are not "natural" man-eaters.

The piranha has also had a great deal of literature written in its honor; it has even been used as the model for the quipper in the FIEND FOLIO® Tome. However, of well over a dozen separate species of piranha, only a few (not including the largest species, which is a devout vegetarian) live up to their reputation. Though piranhas can and sometimes do kill people, most of their attacks consist of nipping off a finger or toe from a person washing in a piranha-infested river. Some stories of their speed in carcass-stripping are plainly exaggerated, but one school is recorded as reducing a 100-pound capybara to the skeleton in less than one minute. Two minutes or less is required to finish off a grown man — assuming the whole school concentrates on him. As with sharks, it is often the scent of blood that sets piranhas off in a feeding frenzy.

### Some wilderness scenarios

Of course, all this information is useless unless the DM actually get the PCs out into the great outdoors. Since obvious manipulation by the DM generally antagonizes players, some originality must be shown. Stranding players in the wilderness due to

shipwreck wears thin after the first few times, as does getting them lost en route to a dungeon because the guide ran out on them or got killed.

Exploration is one major scenario that is not often used, and it is always a good way to introduce new monsters — why not new animals as well? As a related scenario, a PC might be enticed to build a stronghold on the frontier and attract settlers. Given the kill record of some carnivores, it is obvious that supernatural monsters are not always needed to force the abandonment of such a settlement, or to limit its growth as a result. Hunting down livestock killers and man-eaters is good adventuring practice for stay-at-home landowners, and it should be far more frequent than sallying forth to slay dragons.

Conversely, the PCs could be mercenaries hired to rid the neighborhood of predators because the local authorities cannot or will not do the job themselves. If a war is on the horizon or in progress, the local ruler may not be able to spare any troops for this purpose. Otherwise, he may have darker motives. Since predators have proven their ability to depopulate regions, they could prove to be an ideal means for running peasants off their farms. If the local despot covets more land, but doesn't want to seem overtly evil by seizing it, he could simply make up excuses for not being able to send aid, thus letting the carnivores do his dirty work for him. This allows for politics, plots, intrigue, and the like to appear in game play. For example, what happens if a character discovers that this is how the monarch acquired the land which was then granted to him? One way to find out is to play through the scenario yourself.

Another possible scenario is, of course, the mercantile scenario — i.e., hunting animals for profit. Killing elephants for their ivory is the main version of this scenario, but there are others. As Katherine Kerr explained in DRAGON issue #94, a medieval-style army is hard-pressed to find enough food, so PCs might be able to turn a profit by hunting to supply the troops with fresh meat. The same goes for isolated settlements. In the Old West, many market hunters made a living by hunting game to supply meat to mining camps and small towns which had not yet been reached by the railroads. This is an excellent occupation for BOOTHILL game characters, since large and small game is plentiful in almost any pre-modern environment.

If referees follow the example of real-life animals, they should be able to keep their players on the ball without constant introduction of newer and better monsters, magic items, or technological artifacts. The introduction of tougher, wiser mundane monsters should spice up any campaign, whether it takes place in modern India, medieval Europe, colonial Africa, or Elf-land. As they say in the safari movies, "happy hunting." ↑

# ROBOTECH

The Role-Playing Game

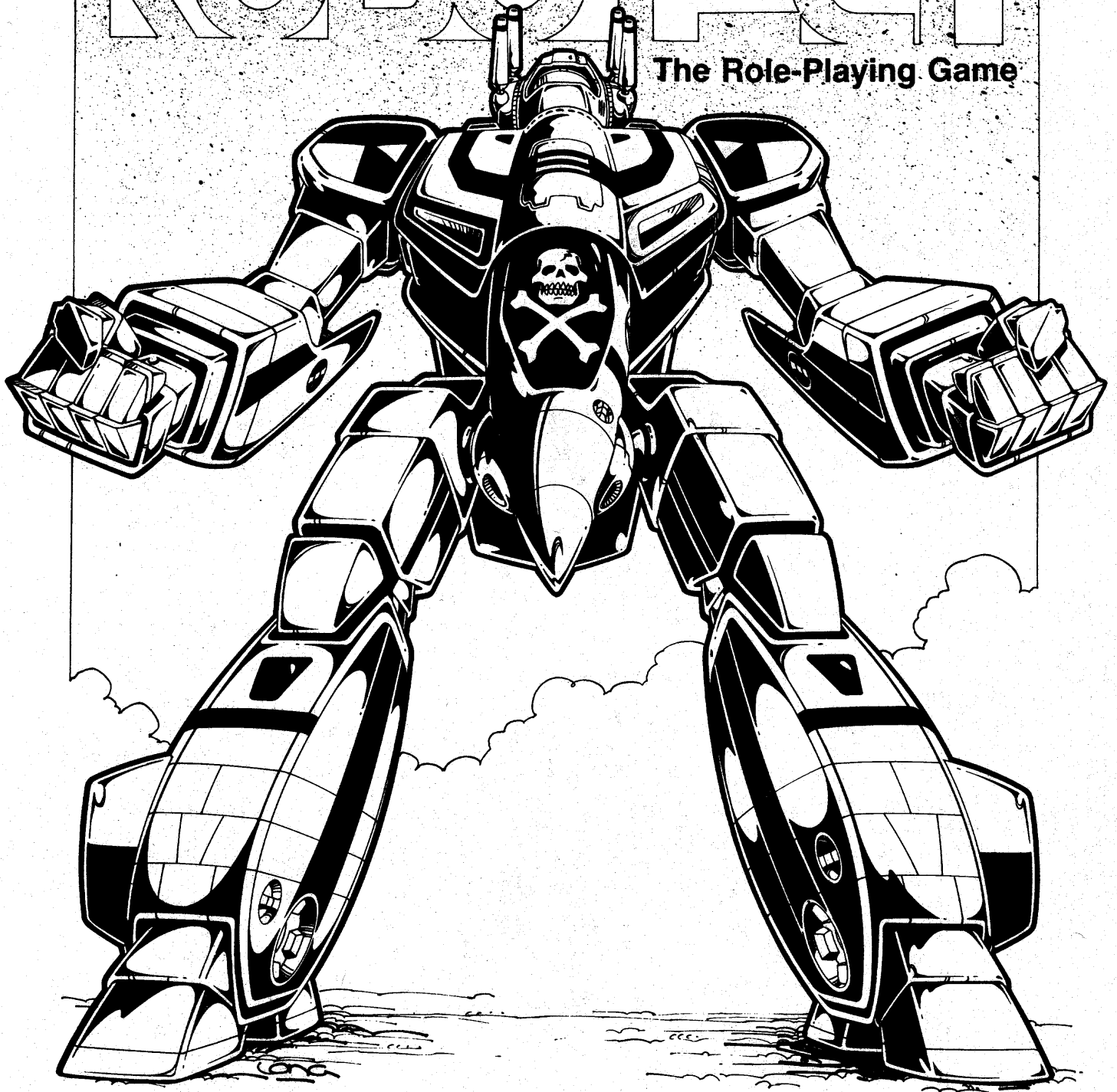

## BOOK ONE: MACROSS

- Complete Basic Rules
- Quick playing, realistic combat with hit location & critical hits.
- Details on the SDF-1, robotechnology, protoculture and all mecha.
- Zentraedi history, technology and war machines.
- Introductory adventure scenarios and more!
- \$9.95 (post paid) — 114 pages

Palladium Books®  
5926 Lonyo  
Detroit, Michigan 48210  
Dept. D

**Don't Settle for Imitations!**

Copyright © 1983, 1984, 1985, 1986 Kevin Siembieda.  
Characters copyright © Harmony Gold USA, Inc./Tatsunoko Production Co., Ltd. All Rights Reserved.  
"ROBOTECH" is a Trademark Owned and Licensed by Revell, Inc.

# High Ones, Ancient Ones

SHE RAISED THE STRANGE-LOOKING CUB,  
FED HIM FROM HER OWN MOUTH,  
PROTECTED HIM FROM HARM.

YET THE DAY CAME  
WHEN THE REMAINING  
SPARK OF A HIGH ONE'S  
WISDOM TOLD TIMMAIN  
THAT THE CUB'S ELF  
BLOOD MUST BE  
ACKNOWLEDGED.

Art by Wendy Pini  
©1986 WaRP Graphics

---

by Michael DeWolfe and  
Galan Akin

---

The following article has not been officially approved by Chaosium Inc., the producer of the ELFQUEST® role-playing game, or by WaRP Graphics, the producer

of ELFQUEST Magazine, and it is not an official supplement to any part of the rules. — Editor

The ELFQUEST game rules make several references regarding High Ones, but statistics on them and a method for generating them are not provided. The following article is designed to aid Game Masters in using High Ones in their campaign, as well as to provide some material on role-playing on the ELFQUEST world around the time of the High Ones' arrival, 10,000 years before the time of Cutter's quest.

## History

High Ones are the parent race of all elves on the World of Two Moons. They are highly evolved beings who left their original world when it died. The High Ones discovered that they could harness an energy force within themselves, enabling them to control and manipulate nature. This energy source gave them many powers, including that of telepathy (sending), shaping mineral and vegetable matter, and the ability to change their own form at will.

When the High Ones left their homeworld, they separated into small groups. Each group took with them members of the two only surviving animal species left on the planet. These species later evolved into the preservers and the trolls. The trolls became the High Ones' menials, but the trolls resented this position and their masters.

The High Ones traveled to many different worlds, using their shape-changing powers to disguise themselves as natives of those worlds. One group came to the World of Two Moons searching for other High Ones, and chose to explore an area with a culture similar to that of medieval earth, disguising themselves as the elflike beings that later became the elves of that world. They shaped their spherical vessel into a palacelike structure to further enhance their disguise. In this way, they hoped to appear as spirits from the native humans' legends, so the High Ones might find a sign of their lost kin. The High Ones did not plan to stay long, for they knew the World of Two Moons would have a draining effect on their powers.

The trolls, however, had different ideas. They waited until the palace was about to land, and then sabotaged its guiders. This sent the vessel out of control and catapulted it back into time. When the castle landed, the trolls took their chance to escape. The confused High Ones, upon leaving the safety of the palace, were attacked by the primitive humans of that time period. These humans were savages and had no wood-spirit legends. Their fear of the advanced High Ones caused them to strike out and slaughter most of these incomprehensible beings.

The few survivors among the High Ones went on to form various tribes of elves. At the time Cutter's quest takes place, all High Ones are thought to be dead. Some, however, may have survived through various



methods — by learning to survive on the world, by remaining with an elf tribe and lending that tribe the High Ones' ancient wisdom and magic, or, like the elf-wolf Timmain, by using their shape-changing powers and remaining in a certain animal form for thousands of years. A High One trapped in one form for thousands of years adopts the thought patterns and instincts of his or her animal form and is only partially aware that he or she is actually a High One.

### Encountering a High One

Since their arrival on the two-mooned world, the population of High Ones has dropped steadily. Within the first thousand years on the world, as many as 30% of the elves encountered could be High Ones. Five thousand years before Cutter's quest, no more than 5%-10% of all elves were High Ones. Now, at the time of the quest, less than 1% of all elves are High Ones. Considering the total population, such a low percentage indicates probably only about 1-5 High Ones remain alive on the world today, including Timmain. These numbers, of course, may be altered by individual Game Masters, and some Game Masters may wish to have a whole tribe of surviving High Ones (though obviously a small tribe), who have hidden from the human menace and other dangers in some secluded place.

Such a tribe of High Ones would probably be very advanced, having learned to use their magic powers to their full extent, despite the world's negative influence. The location of such a tribe would be out of the way — difficult both to locate and to reach. Game Masters should note that although this article provides rules for player character elves, it is up to them to decide whether these elves unbalance the game or not, and whether or not High Ones can only be non-player characters. Remember that the elf-form is not the true shape of the High Ones and that it may be possible to encounter a High One who has reverted to his original, almost featureless form, unrecognizable by other elves.

The High Ones, or Firstcomers, would have one of two different psychologies. A High One could still retain his old nature; he or she would then use magic often, be dependant on it, and be unaccustomed to the necessities of the real world. This type of Firstcomer would be shocked at the sight of killing and death and, though mentally strong, would probably be quite weak physically. The High One might not have produced any offspring, because the original High Ones had almost forgotten how to mate due to the lack of death among them.

The other type of High One would be a more adaptive, adjustable figure who represents the foreparentage of elfkind. If the new life calls for killing and death, then these High Ones would adjust to such a way, although they have naturally maintained a very strong respect for life. They

also have Recognized, producing offspring that began the race of elves, and are kinder to their kin than the previous type of High One. High Ones, in the view of their descendants, are as nearly perfect as any elf should be, and rightfully so.

### Generating a High One

The method for generating High Ones' characteristics is presented below. Note that their STR and CON scores tend to be low, due to their lack of physical activity and dependence on magic, but that their INT and POW scores are extraordinary for the very same reasons. Although they possess remarkable POW, their Magic Points should be slightly less because of the weakness of their powers on this world. Their Magic Points should also be influenced by their intelligence, as a smart High One could probably learn how to tap the forces of the world better than a less intelligent one. Therefore, when determining Magic Points, we suggest subtracting 3d3 from the total and adding one Magic Point for every point of INT over 17, making sure that the total never surpasses the maximum Magic Points the character could have according to the character's POW.

High Ones' characteristics are as follows:

Characteristic	Dice Roll	Average
STR	2d6 + 1	8
CON	2d6 + 2	9
SIZ	1d3 + 12	13.5
INT	d10 + 12	17.5
POW	2d6 + 13	20
DEX	2d3 + 9	13
APP	2d3 + 14	18

*Age:* Treat as 10,000 + years

*Move:* Three yards per strike rank/ground and six yards per strike rank/gliding

The sorts of weapons available to High Ones depends on a number of factors. Most weapons are developed purely for hunting purposes and are invented after examining the native creatures. For example, a giant hawk may give a High One inspiration to develop a fighting claw. A bear's claw may provide inspiration for a dagger and a sea shell may inspire a shield. Spears are improvements on daggers, giving better reach and lessening the chance of injury. Swords are the trolls' weapons, as swords are more oriented toward combat than hunting.

A High One's weapons are most likely of leather, wood, and bone or stone. High Ones may, however, acquire metallic, forged weapons from trolls, or they may develop the necessary skills (using magic powers) and resources to forge metal themselves. They may also craft metal weapons as the Sun Folk do, using softer metals, although troll-forged items are of higher quality.

Skills are defined for three different "classes" of High One, Class A is used for role-playing a Firstcomer in the time period within 2,000 years of their arrival. Class B is for the period up to 6,000 years ago, and class C is for the time up to Cutter's quest. The skill table may be found on the following page.

Some of these skills may be changed, depending on the lifestyle the High One has assumed, but this is up to individual Game Masters. For previous experience, use the same methods used in the Elfbook, with the following changes.

Total the character's rolled characteristics, but multiply the result by only six. Increasing a characteristic point costs 80 instead of 60. In addition, there are certain restrictions on increasing some skills. Magic powers can be increased to any amount.

The following skills have no restrictions on them for increase through previous experience: any magic power, any Lore (except Troll Lore, Mechanical Lore, and Mineral Lore), Communication, Manipulation, Perception, Ride, Stealth, and Swim.

The following skills cannot be increased through previous experience above half again the original score given them: Climb, Dodge, Jump, Mechanical Lore, Throw, Attack with any one weapon, and Parry with any one weapon. The remaining skills cannot be increased through previous experience by more than 10 percentage points over their original percentages.

### Magic Use

High Ones, unlike their descendants, are eligible to use all magic powers. Originally, all High Ones probably had access to all of the powers listed in the Elfbook, but many of them lost most of their powers when they arrived on the World of Two Moons because of its draining effects. All High Ones have at least Sending, Astral Projection, Magic Feeling, Levitation, and Shape Changing. Individual High Ones, who originally had every power, may have lost these powers due to atrophy over a long period of time. They may have found they were particularly talented in one power, and so concentrated on learning how to use that power on the World of Two Moons and neglected other, more difficult powers. There is still a chance, however, that a Firstcomer may have every power.

The earlier the time period used as a campaign setting, the more likely the High One elf will have all the magic powers listed. The more recent the period, the more likely it is that he or she will have concentrated on one or two powers and so will have forgotten others. Below are listed the methods for determining magic powers for the three classes of High Ones explained above.

High Ones played in an early setting will have the following chances for retaining a given power (Class A). Note that this does

not cover their actual percentage with the power, which is explained further on. Also note that these chances should also depend on the environment. For example, a High One living in the desert would have little or no chance of retaining Plant Shaping, but would almost certainly have Rock Shaping. This is left up to individual Game Masters.

Power	Chance of Retaining
Anti-Healing	POW/3
Fire Starting	POW x 2
Flesh Shaping	POW
Healing	POW x 4
Levitation	Automatic
Plant Shaping	POW x 4
Rock Shaping	POW x 4
Shape Change	Automatic
Animal Bonding	POW x 5
Astral Projection	Automatic
Finding	POW x 3
Hypnosis	POW x 2
Sending	Automatic
Shielding	POW x 4
Magic Feeling	Automatic

High Ones played in a setting up to the time before Cutter's quest will have begun to specialize in certain powers, and there is consequently a good chance that they have not retained every power (Classes B and C). Of course Game Masters should modify which powers the High Ones will have retained, depending on environment.

In order to determine the number of magic powers a High One possesses, roll a d6, adding one to the result for every point of POW above 18 possessed by the character. This is the number of powers the elf possesses, which he may choose from all powers available. If the result is

less than 5, then the High One has forgotten one of his automatic powers, to be chosen by the player. Except in the most unusual cases, this lost power cannot be Sending or Magic Feeling.

Once the player has determined how many powers his character has, he may choose to have fewer powers than he is eligible for, if he feels that having more magic powers will spread his percentages a little thin. A Game Master may still state that a character cannot choose a given power due to the character's background and the environment to which he or she has adapted.

Once the actual powers that the First-comer possesses have been decided, then his or her actual ability with the powers must be determined. Use the table given below to determine the skill of a High One with a given power.

Power	Ability
Anti-Healing	POW
Fire Starting	POW x 2
Flesh Shaping	POW x 2
Healing	POW x 3
Levitation	POW x 4
Plant Shaping	POW x 2
Rock Shaping	POW x 2
Shape Change	POW x 4
Animal Bonding	POW x 3
Astral Projection	POW x 4
Finding	POW
Hypnosis	POW
Sending	POW x 5
Shielding	POW x 3
Magic Feeling	POW x 5

There are no restrictions to distributing percentiles among magic powers using previous experience.

### Soul names and sending

High Ones do not have soul names, although their mode of sending is even more intense than that of the Wolfriders or the Sea Elves. This is because they do not need to guard their innermost secrets from each other, and experience an extremely intimate form of sending among themselves. This powerful sending is too much for most normal elves to bear, however, and is especially difficult for elves who use soul names, such as the Wolfriders.

When a High One sends to an elf who possesses a soul name, that elf must try to match his POW vs. the POW of the High One on the resistance table. The elf gains a + 10 percentile chance because the High One is not actively trying to wrest the soul name from the elf. If the High One does not realize what he or she is doing and does not stop sending before the elf fails to make two successful checks on the resistance table, then he or she can acquire the soul name of the elf. Naturally a High One would never consciously attempt to do this; if it happens, it will be accidental. If the High One does gain the soul name of the elf, then he or she can succeed in any mental attack on the elf, although a High One would never use this advantage to harm one of his or her descendants unless there was no alternative.

If the elf does lose two rolls on the resistance table, he still has a chance to protect his soul name. A successful Sending roll will prevent the High One from obtaining the elf's soul name and will make the High One realize what he or she is doing, in which case he or she will stop. If the elf fumbles this roll, then he loses two magic points.

Determining Recognition for High Ones is different too. If the High One is being played in the time period within 2,000 years of his arrival on the world, then there is a POW x 3% chance that the elf has Recognized and a POW x 2% chance that the elf is still alive. If the Firstcomer is being played in any time up to the present, then there is a POW x 4% chance of the elf being Recognized and a POW x 1% chance that his or her lifemate has survived.

In summary, playing a High One can be an interesting experience, but control will have to be exercised, both on the part of the Game Master and the player. Previous experience, when allotted to magic, should be concentrated mostly on one or two powers, usually Levitation and Shape Change. Generally, other players should treat the High One PC differently as well. Elves and preservers will be over-respectful of High Ones, trolls will treat them with more respect than other elves, and humans will likely fear High Ones on first sight. The information presented in this article can be especially helpful to Game Masters wishing to run campaigns in much earlier time periods than those given in the game system.

### Skill Table

Skill	Class A	Class B	Class C
Animal Lore	INT	INT x 2	INT x 3
Climb	STR + DEX - SIZ	STR + DEX - SIZ	STR + DEX
Communication	(INT x 2) + APP	(INT x 2) + APP	(INT x 2) + APP
Dodge	INT + DEX - SIZ	INT + DEX - SIZ	INT + DEX
Elf Lore	INT x 5	INT x 4	INT x 4
Healing Lore	INT x 2	INT x 4	INT x 5
Human Lore	INT/2	INT	INT x 2
Jump	STR + DEX - SIZ	STR + DEX - SIZ	STR + DEX
Language Lore	INT/3	INT	INT x 2
Manipulation	STR + DEX	STR + DEX	STR + (DEX x 2)
Mechanical Lore	INT x 3	INT x 2	INT
Mineral Lore	INT x 3	INT x 2	INT
Perception	INT + POW	INT + POW	INT + POW + 5
Plant Lore	INT	INT x 2	INT x 3
Ride (Creature)	DEX + (INT/2)	DEX + INT	DEX + (INT x 2)
Stealth	INT + DEX - SIZ	INT + DEX	INT + (DEX x 2)
Swim	DEX	DEX	DEX + STR
Throw	STR + (DEX/2)	STR + DEX	STR + DEX
Troll Lore	INT x 5	INT x 4	INT x 3
Attack w/ weapon	DEX + (STR/2)	DEX + STR	DEX + STR
Parry w/ weapon	DEX + (POW/2)	DEX + POW	DEX + POW

# The Role of Computers

by Hartley and Pattie Lesser

Communication is the glue that cements mankind together. The intelligent communion between human beings is what distinguishes us from animals. And, allegedly, it is this communication that prevents our national egos from destroying ourselves.

Communication is ticklish in real life, as it is in our worlds of fantasy and adventure. Fortunately, our gaming realms are of our own imaginings. Granted, the involvements of our characters, in terms of their interaction with NPCs and other assembled beasties, do take on the proportions of substantive life at times. Caution, care of life, and reward based on deed seem to be the rules of the game. Likewise, it is the art of communication between player and game master and between players that provides the rewarding outcome of any quest.

Certainly, there are game masters who ignore communication with their players, much as they also disregard rules of good gaming by insisting upon either niggardly reward for heroic deeds or the heaping of outlandish bounty for minimal struggle. Upon encountering such a game master, once again, communication between player and controller can usually settle observed differences in the playing environment.

So, obviously, communication among ourselves is as important to successful role-playing as it is in the business world or in the environs of school or college. As such, we must thank all of you who have written to us expressing your likes and dislikes regarding this column. Thankfully, most letters have been complimentary; we are certainly glad to have been covering areas of interest to most of you.

Two specific areas of concern among those who wrote to us are matters we'd like to discuss before dissecting the two programs under review: *Dragonfire II* and *Bard's Tale*. The first area of query deals with our method of selecting programs for examination. Several suggestions have been received regarding games you'd like to see reviewed.

First, the software under scrutiny must

be available to any consumer as a mainstream product — in other words, available either by mail order or through a local retailer or computer user group. Granted, there may be many marvelous adventure and fantasy role-playing games hidden away on some mainframe system in Nova Scotia or hidden under some password protected by BBS (bulletin board system) in Rio de Janeiro, but if DRAGON® Magazine readers can't obtain that product, we feel it's unfair to the majority to scrutinize the game. So many mainstream programs are currently being released that we must concentrate our full energies on material that is available not only nationwide but also on programs that are microcomputer-oriented. We doubt whether too many DRAGON Magazine readers have access to a Digital Equipment Corporation VAX computer, an IBM System 38, or a Unix/Xenix supermicro. Therefore, we have decided to review programs that run on the following machines: Apple II family (which consists of the II+, IIe, IIc, and the new color machine), Apple Macintosh, IBM micros (PC, XT, AT, PCjr) and compatible computers (like the Tandy 1000 and 1200, Hewlett-Packard Vectra, or Corona, Toshiba, IIT, AT&T, *ad infinitum*), Commodore 64/128 and Amiga, and the Atari 8-bit machines (600, 800, 1200, XL, and XE), as well as the Atari 520 and 1040 ST.

Therefore, in these areas mentioned, your input would be greatly appreciated. If you know of a program that does fall within these listed areas of interest, please write to us with that product information. We'll do the rest!

Game hints were another area mentioned to us. We feel that the challenge to adventure and role-playing games rests with the user's ability to solve puzzles. Without the riddles, you simply have a "slay-and-play" game whose redundancies lead to a boring time at your computer's keyboard and monitor. We will let slip, occasionally, a hint, but the important puzzles are best left to you to solve. That's the reason you purchased the program in the first place: to be challenged and to

solve the puzzle, and thereby reap the true reward of personal satisfaction. You wouldn't want your game master to inform you of all the traps, encounters, and special hazards he has planned for your adventuring party in the quest before play, would you?

Finally, one extremely well-informed writer from Canada wondered why so many of the current crop of computer fantasy games seem to lack the special features that certain other computer fantasy games have. This is a problem involving computer memory. If you have a graphically active game, that means there's less room for code that enhances a character, and vice versa. If you have a game that has a tremendous parser for interaction with the computer, giving your system commands to control the onscreen player, then the graphics tend to be static, with far less animation involved. Until standard computer memory rises above its current limits, program coding must pack a great deal of information into the relatively small RAM (Random Access Memory) space. Consider also that there are very few perfectly administered adventure games refereed by a game master, in spite of the unlimited storehouse of his human memory.

We will also attempt to analyze more than one game per column, although the time constraints for in-depth reviews of more than one or two complex programs are a reality. (We write extensively in the computer field for computer magazines, as well as publishing our own weekly computer magazine, and have limited hours in which to devote to this entertaining environment.) However, we'll see if we can do better. Unfortunately, we can no longer reply personally to all of the letters being received. We'll attempt to discuss those areas you feel are important, and hope we can address your specific issues with clarity. Now, on with the column.

Speaking of communication, probably one of the most critical areas in gaming is the ability of the game master to communicate the rules of play to the players as the game progresses. Most of the time, such communication is left wanting — the game master requires time to roll the die or look up the appropriate rules in this or that gaming guide, consult her judge's screen for encounter matrices, or engage in the mathematical computation necessary for awarding the appropriate number of experience points or gold pieces to each character involved in a melee. Wouldn't it be nice if there were a computer program that could alleviate these mechanical responsibilities and give the game master the opportunity to pay closer attention to the game itself? Good news for all: there is one program that *does* afford the game master time for closer interaction with the adventurers, where play becomes the thing. This program is *Dragonfire II* from Magicware.



Our attention focused upon Magicware when requests from several DRAGON Magazine readers asked that we look at *Dragonfire*. Our immediate feeling was that, if the program could manage rule communications for players of all games, without being too complex to learn or manage, the program would certainly be worth a look. As chance plays a role in most matters, after we received your letters, a beta version of the new *Dragonfire II: The Dungeonmaster's Assistant*, for the IBM PC and compatibles, arrived from Magicware. A beta version, in software parlance, is a program that is still being tested, but is, in reality, quite close to being produced for the commercial marketplace. When we worked with *Dragonfire II*, most of the program's bugs had been eradicated, and the finer points, such as Help files and data tables, were being spruced up. We felt quite comfortable reviewing the beta version, as this offering presented all the capabilities that will be found in the released rendering.

*Dragonfire II* is truly a worthwhile program for any game master! We heartily recommend this program to anyone involved in managing adventure campaigns. The fact that *Dragonfire II* is flexible enough to handle almost all of the differing adventure environments is a real plus. As dyed-in-the-wool gamers, we found the elements within *Dragonfire II*

extremely easy to use. Plus, we weren't limited only to using that program's files, since the user can easily input his or her own material into every table, including random monster appearances, treasure tables, battle elements, and the creation of new beasties and characters. Once your own statistics and data have been saved to disk, the only limit to the amount of detail the program can handle is the amount of storage on your disk.

You'll hear the terms *ease-of-use* or *user-friendly* bantered about continuously in the computer industry. These indicate that a program is not difficult to learn or master; *Dragonfire II* falls into this category. The entire operation is menu driven, meaning that for every user action, there is a menu that manages the activity. A main Workspace (Table 1) allows the user to see what elements are available for immediate access.

The top line is the Command Line, where you select the various *Dragonfire II* commands that you will need. The remaining area is the Workspace itself. The amount of data revealed here depends entirely upon what you've selected from the Command Line. For example, if you wish a Help file, you have to move your computer's cursor (usually a highlighted box located on a command in the Workspace) to the Command Line. This is done with a press of the backslash (/) key. The

File Name	Size	Date	Time	Attributes
MULTIREF	1275			
PARTY	1275			
MONST	1275			
...	...	...	...	...

Table 1: *Dragonfire II* screen, showing Command Line and Workspace for game mastering

cursor jumps to the Command Line at the top and may be moved to any command desired in one of two ways. You can either move the cursor with the cursor control keys (right or left) or enter the first letter of the file itself (H for Help, E for Expand, and so on).

Once a command has been selected by moving the highlighted cursor to its name, the Return or Enter key is pressed. A window springs up on the screen, and you simply scroll through the information presented until you find what you are looking for. When done, a press of the Escape key returns you to the Workspace.

Each command is responsible for the following designated activities:

**Get** — As shown in the screen above, the Workspace is currently empty, simply showing the fields of information that will be displayed once a file has been called from the disk for manipulation. Get does the getting, so to speak. When accessed, a window appears below the command revealing what you can Get for placement into the Workspace: Randomized Monsters, New Characters, Parties, Monster Individuals, or Character Individuals. An entire list of all data specific to the selected file will appear in a window. You simply scroll through the displayed list with the cursor control keys and move the highlighted cursor over the information you want to put in the Workspace, then press your Return or Enter key. If you selected Character Individuals, all of the characters that you've prerolled and saved to disk are displayed, and you can select any one you wish.

**Expand** — As you can see by looking at the Workspace, not all of a character's or beastie's information can be shown in one viewing. By selecting with the highlighted cursor any of the names in the Workspace and then pressing the backslash key, you can move the Command Line cursor to Expand and see that particular element expanded to reveal more detail. For example, your character may possess a variety of weapons, from a Deluxe Dueling Dagger to the Stunning Sword of Sirgotto, but

## TAKE TO THE STREETS!

Take action to the streets with this exciting supplement for MEKTON. With **ROADSTRIKER**, transforming Mechacars, Personal Armors, Advanced Police and other hightech mecha are at your command! Add new dimensions to your MEKTON campaign: danger, drugs, fast cars, and Mechabikers all come together in the exciting police adventure, **ARCADIAN DEATHROAD**, included in **ROADSTRIKER!** ALSO INCLUDED—**TRANSFORMABLES**—a new expansion for designing multiform, multi-environment mecha. NOW!—**ASTROFIGHTERS, HYDROFOILS, TANKS, WALKERS, BEASTMECHA** and **MANY OTHER EXCITING TYPES** can be added to your MEKTON Campaign. **ROADSTRIKER**—Now the Streets belong to You!

**ROADSTRIKER™** from  
**R. TALSORIAN GAMES INC.**  
 Box 2288, Aptos, CA. 95001-2288



INTRODUCING BALDERDASH®  
THE HILARIOUS NEW BLUFFING GAME.

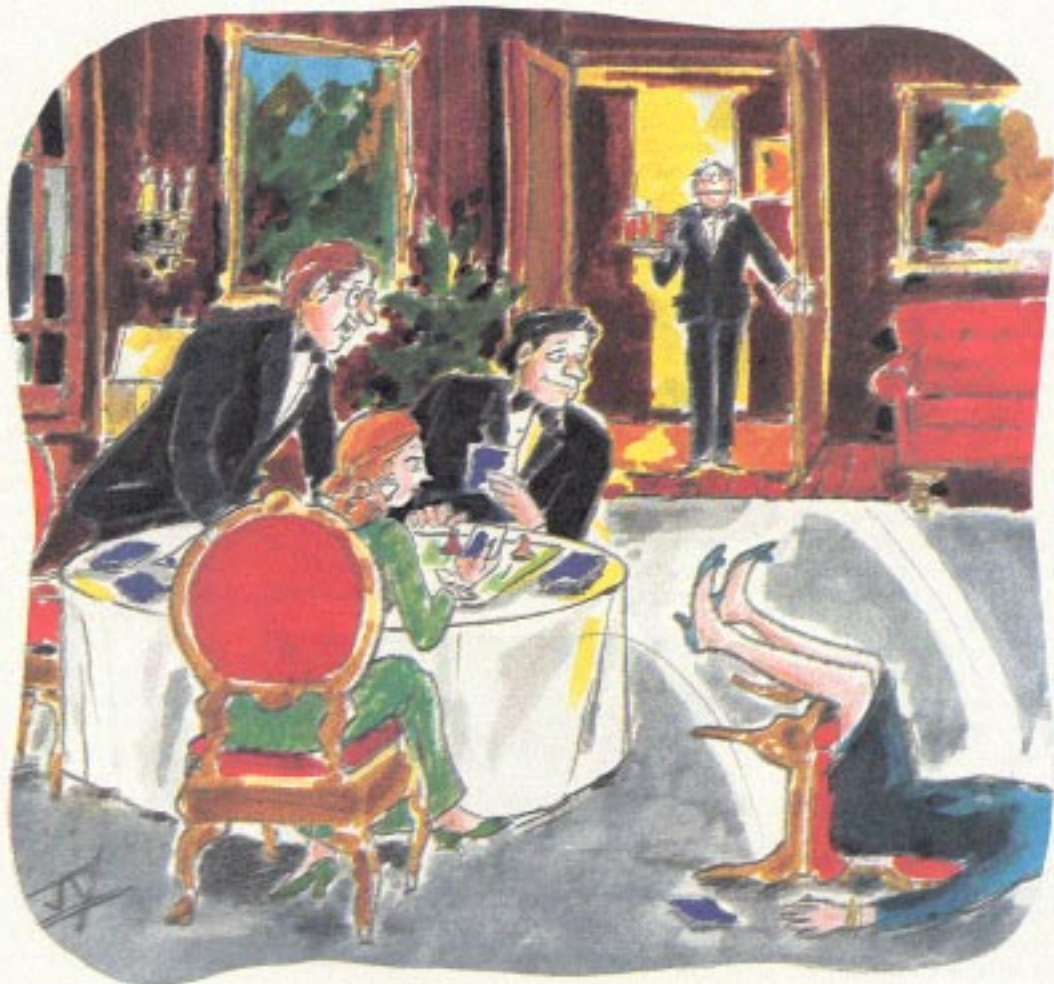

*"All I did was ask what 'GINGLYMUS' was."*

**"GINGLYMUS" IS DEFINITELY NOT THE  
SKIN BETWEEN YOUR LIP AND  
YOUR NOSE. . . BUT IT COULD BE.**

**THAT'S  
BALDERDASH®!**

BALDERDASH® is a battle of wits that combines your knowledge of words with the skill of poker. Now what's a "GINGLYMUS"? Anything you want it to be, from the jelly from a sturgeon's bladder to a tropical plant.

That's why even if you don't know the real definition of a single one of our 2,500 outrageous & whacky BALDERDASH words, you can still be a winner—as long as you can bluff. That's BALDERDASH!

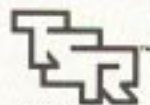
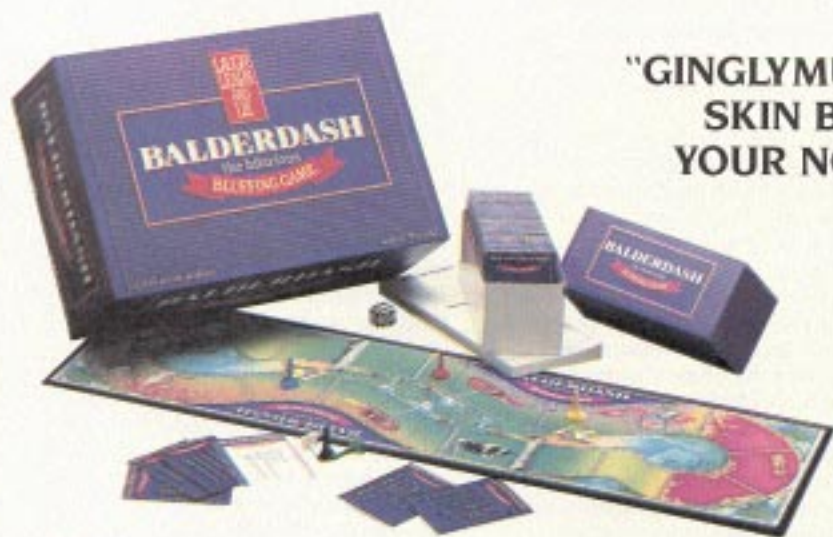

TSR, Inc.  
PRODUCTS OF YOUR IMAGINATION™

BALDERDASH® & ©1986 Gameworks Creations, Inc., sold under license by the Canada Games Co.  
The TSR logo and PRODUCTS OF YOUR IMAGINATION are trademarks owned by TSR, Inc. ©1986 TSR, Inc. All Rights Reserved.



these can't be viewed directly from the character sheet. By expanding the weapons list, you can view not only the weapons' names but their attributes as well, all of which appear in another window.

**Tables** — All table activity takes place with this command, giving you the ability to modify, view, and roll on all tables saved to disk. Such items as Treasure Tables, Encounter Tables, and XP Tables fall within this commands realm.

**Battle** — One of the more unique tables, here the game master can input a wide variety of characters and opponents, and have the computer manage the battle, based on the abilities and attributes of the contestants: their armor class, weapon skills, etc. When this window appears onscreen, the game master only has to highlight the attacker, then the defender, and the computer displays all of the pertinent modifiers and indicates whether there was a hit or not. The damage resulting from the hit is indicated. However, the game master may alter the listed damage as he sees fit, or may merely reroll the melee. Once the first swing has been approved, the computer automatically deducts the damage from the defender, and the melee continues — unless, of course the defender is now deceased. The computer asks again for attacker and defender, and the results are determined. This can continue for as long as there are folk left standing around wanting to take a hit or administer one.

**Options** — This contains less frequent used but still important commands. On the most powerful of these commands the Create command, which allows the game master to create new monsters or characters using an easy-to-enter template. Once the character/monster has been created, it can be incorporated into the current game simply by moving it to its appropriate table. You can also change the field names themselves, input individual prerolled "nasties and goodies," and create any number of new tables. Perhaps you have need of a good wind table for your transoceanic voyages: with the Options command, you can do just that — set up a new, customized table.

Other commands in the Options window include Save (which saves whatever is in the workspace to your data disk), Print (which printing out your worksheet or character/monster sheet), Remove (which deletes unwanted guests from your Workspace), Erase (which permanently deletes any kind of file from your disk), Organize Parties (which brings together those separated folk and beasties in the Workspace into specifically named parties), Quit (which displays an "Are you sure?" message, for if you haven't saved your new data prior to answering yes, all of the changed information is lost), and Drive Control (nice for those with hard disk drives or two floppy drives, as it allows you to change the default drive for saving data).

We used *Dragonfire II* to play both ADVANCED DUNGEONS & DRAGONS® and TUNNELS & TROLLS games, and found that the increase in play was dramatic! With the game master being allowed to ignore certain die rolls, the personality of the game was never lost to the computer. A much closer eye was kept on the players themselves — not only as a control factor, but also as a means to determine if alignments were being violated through talk or other activity that normally wouldn't be noticed because of the game master's other activities.

You have to realize that *Dragonfire II* cannot manage all of a game's details. There is only so much memory in the computer; thus, certain elements have to be left out in order to cover most of the major environments of gaming. Elements such as a creature's special attacks (poison tongue, eye of stone, etc.) must be applied to any designated hits by the game master. Surprise rolls are not automatically determined by the computer during a Battle sequence. We found that the best way to manage such an activity was to first Cre-



A sample screen from *Bard's Tale*, revealing an unpleasant encounter

ate a surprise table and roll on that table prior to accessing the Battle module. The same applies to dropped or broken weapons. The program's ability to allow the game master to create any table needed is a real blessing.

For those who currently own the original *Dragonfire* program and have been less than pleased with its slow performance, smile! The new *Dragonfire II* is written in Turbo Pascal and operates quickly, even at the 4 MHz speed of an IBM PC. If you have an IBM AT or compatible, or an accelerator board that pumps out at 8 MHz, you'll see a remarkable difference from the original game. Also, Magicware is currently writing three actual adventure modules that interface with *Dragonfire II* — just perfect for those occasions when you cannot find (or haven't the time to get together with) your normal gaming group. With these modules, you can run solo adventures with all of the *Dragonfire II* capabilities at your fingertips to manage the game. The modules also interface with one another, so that you have the start of an entire campaign world on three floppy diskettes, all

with original monsters and treasures.

Although our beta version was for IBM micros and their compatibles, *Dragonfire II* will also have been released in versions for the Commodore 64/128 computer, the Apple II family of computers, the Apple Macintosh, and Commodore Amiga by the time this review sees print. Just around the corner is a version for Atari 8-bit machines, such as the XL and XE family. However, the program must be reworked due to the limits of that machine. Pricing is \$34.95 for the Apple and Commodore versions, and \$39.95 for the IBM version. Additionally, a mini-module will be included in the final version of *Dragonfire II*. The coming modules will all be priced at \$24.95 each and include: *Forest of Rith-Barradu* (#1), *City of Dukarton* (#2), and *The Forbidden Dungeon* (#3). Although we haven't actually viewed these adventure modules yet, we spoke with their designers. The adventures sound extremely exciting, worthwhile additions to an adventuring environment.

We now have two rules for gaming at our house: no game master is without his die, and no game master is without *Dragonfire II*. Granted, not all players have access to a computer, but at least you now have good reason to think about the acquisition or loan of a system just to experience the benefit that *Dragonfire II* presents. This program is highly recommended to all.

Our featured fantasy role-playing computer game for this column is none other than *Bard's Tale* from Electronic Arts. Phew! What a game! It is guaranteed that this one will leave you physically exhausted. One of the immediate highlights is a character type called a bard (hence the game's name). Certainly, there are the typical characters — magic-users, fighters, and thieves — but the bard is a special individual. He not only fights, but his songs have either special positive effects for his party or unpropitious effects on adversaries. Also, the bard is inclined to drink rather heavily, which is good, as without the beverages of buzz to soothe his parched throat, he couldn't sing! And without his songs, your adventure would be short-lived indeed.

When in possession of a musical instrument, the bard can be called upon to play such amazing ditties as "Falkentyne's Fury," which drives his fellow compatriots into a berserker rage and increases the damage they do upon an enemy in combat. Number two on the bards hit parade is "The Seeker's Ballad," a tune that negates the need of a torch in a dungeon, as the song coaxes light to brighten the party's way, otherwise increasing the chances that his party strikes damaging hits when in melee. Other hit parade songs include "Wayland's Watch" (which calms down opponents, causing them to do less damage to you), "Badh'r Kilnfest" (which heals wounds during combat), "The Traveller's Tune" (which decreases the chance of



# TURTLE MANIA RAGES ON!

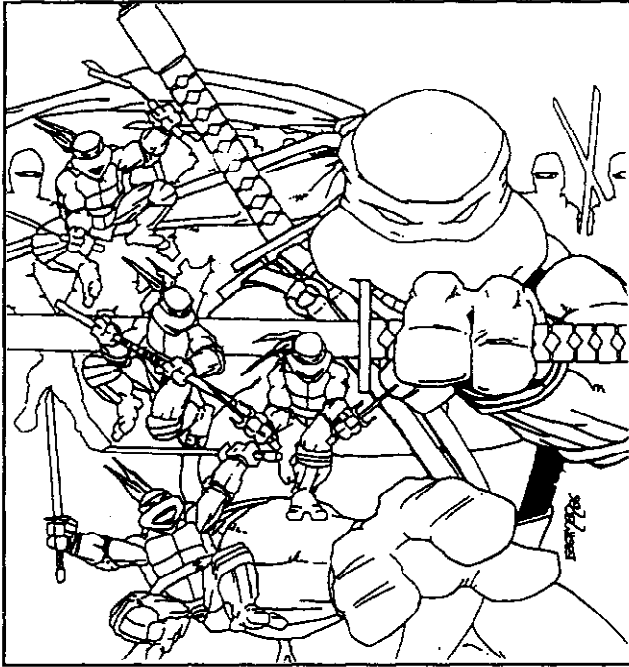

Copyright © 1986 by Palladium Books® 5926 Lonyo, Detroit, Michigan 48210.  
TMNT is a trademark of Mirage Studios.

## The Game . . .

### Teenage Mutant Ninja Turtles & Other Strangeness

The possibilities for **Teenage Mutant Ninja Turtles** are endless. Whether you want to play straight comic book superheroics, post-holocaust mutants or frantic funny animals, it's all possible.

Now you too can transform ordinary house pets into the superheroes of tomorrow. From the family feline or hamster, to lions, tigers and bears, you can create the most unusual superbeings in the annals of history.

**Teenage Mutant Ninja Turtles & Other Strangeness** loyally adapts the comic book with each character, from Raphael to Casey Jones, depicted complete with background and abilities.

#### Highlights Include . . .

- A complete **NEW** game!
- Compatible with **Heroes Unlimited®** and the **Mechanoids**.
- Dozens of characters, villains and heroes.
- Several adventure scenarios and scenario ideas.
- An all **NEW** eight page Ninja Turtle comic strip by Eastman and Laird. Plus page after page of Eastman and Laird art throughout the entire book!
- \$9.95 (post paid)

### Ninja Turtle Supplements . . . Teenage Mutant Ninja Turtles Adventures!

The adventures continue as our heroes travel to Japan to take on the **White Ronin** and his assassins in "Death Trials". Then back to New York to thwart the ever imbalanced **Doctor Feral** and his 'New' monstrous mutations. The **Terror Bears** reap mayhem in a game of nuclear roulette. The unstoppable Mr. Bionic and other adventures round out this Ninja Turtle game supplement.

#### Highlights Include . . .

- A specially commissioned all **NEW** ten page Ninja Turtles comic strip by Eastman and Laird.
- The return of the **Terror Bears** and **Doctor Feral**.
- Five Adventure Scenarios.
- Compatible with **Heroes Unlimited®**.
- **ALL** artwork by Eastman & Laird!
- \$6.95 (post paid) — 48 Pages.

**New!**

## Road Hogs

**New!!!**

Post Holocaust mayhem continues as you explore the highways and the byways of the **west coast**. It is a land dominated by mutant animal bikers and savage gangs. Adventures will pit characters against wild and wooly road hog gangs, marauding robots in Silicon Valley and then south of the border in a life and death struggle against "the Dragon".

#### Highlights Include . . .

- New animal mutations.
- Vehicle combat rules.
- Special eight page comic strip.
- Four adventure scenarios.
- Compatible with **Heroes Unlimited®**.
- \$6.95 (post paid) — 48 Pages.

NOTE: The Ninja Turtles are not themselves featured.

## After the Bomb!®

### A post holocaust science fiction odyssey!

Four generations after World War III, after the nuclear winter, after the plague and after the collapse of humanity, intelligent mutant animals lay claim to much of the world. Join the animal civilizations, the **Rodent Cartel**, **Wolf Barbarians**, **Bird island**, **Gatorland**, and the **Gun Bunnies** in their struggle against the **Robot Warriors of the Empire of Humanity**.

#### Highlights Include . . .

- Animal Mutations.
- Robots and High Technology.
- Six Adventure Scenarios.
- Compatible with **Heroes Unlimited®**.
- \$6.95 (post paid) — 48 Pages.

## Game Additions . . .

### Heroes Unlimited®

Despite all the other superhero games on the market **Heroes Unlimited®** is still the only game that covers every aspect of the comic book hero. Only **Heroes Unlimited®** enables you to build/create a robot or cyborg, in addition to superspies, psionics, aliens and mutants. Comprehensive skills, education and background, enable you to create three-dimensional characters that grow and develop. Guess-work superpowers are replaced by exact power descriptions. Combat is quick, clean and playable.

#### Highlights Include . . .

- Steranko Cover
- Weapons and Equipment.
- Robotics
- Bionics
- Psionics
- Spies
- Mutants
- Aliens
- Special Training
- Superpowers and Skills
- An Introductory Adventure Scenario and More!
- \$14.95 (post paid)

## Complete 1986 Catalog

Send 50¢ for postage and handling to receive the complete catalog of our other fantasy, superhero, and science fiction role-playing games and supplements.

Palladium Books  
5926 Lonyo  
Detroit, MI 48210

party members being hit in melee), and "Lucklaran" (which creates an anti-magic field). The bard is a pretty darned good fighter as well — certainly one worth keeping in the first ranks of the party for his combative skills.

So what's *Bard's Tale* all about? The once-friendly town of Skara Brae has been surrounded with a spell of Eternal Winter, cast by Mangar the Dark, an evil wizard. With the power of his dark influence around the town, all manner of decrepit nasties have filtered into the lower reaches of Skara Brae. To convince Mangar to release his spell requires the formation and rapid training of competent adventurers who can withstand the rigors of Skara Brae — especially the sewers that lie beneath the city streets. When explored, these sewers could lead your party to other exits within the city — and to the unbelievably complex dungeons, where Mangar's hordes lie in wait for the untested and the untrained.

Believe us when we tell you that the training and patience needed to build your characters from ineffective individuals to a cohesive fighting team are mandatory for any kind of success in Skara Brae. This character development is no easy task. Hours of play are required to accomplish the building of your characters. The dangers in and around Skara Brae — especially during the hours of darkness — are

considerable, to say the least! In fact, the novice player may think that battle is all there is to this offering. Movement about the city itself involves all sorts of considerations, such as "Do my characters have enough hit points to survive another encounter?" or "Do we need to recharge my magic-user's spell points?" And the considered movement may only consist of traveling a few doors away from the Adventurer's Guild on Rakir Street!

There are two ways to introduce your party of intrepid adventurers into the Skara Brae environs. The first is to create the characters-from scratch using the program itself. All activity in *Bard's Tale* starts with an opening sequence in the Adventurer's Guild — your safe haven from the dangers of the city. Not only are disk activities accessible from the Adventurer's Guild, but here you can restore and save games in progress, and create your party. In addition to the human race, one can also select an elf, dwarf, hobbit, half-elf, half-orc, or gnome to join the party in one of several character classes (warrior, paladin, rogue, bard, hunter, monk, conjurer, magician, sorcerer, or wizard). Each nonhuman race has a special attribute; the gnomes are more magically inclined than the other races, and hobbits make exceptional rogues.

A party should be comprised of at least two fighters (paladins are great, as they

also possess more resistance to evil magic and can use all kinds of weaponry), a rogue (a thief who can detect and disarm traps in treasure chests), and at least two magic-users (who not only cast defensive and offensive spells, but can also use healing magics).

*Bard's Tale* is unique in that there are various classes of magic that must be considered: wizardry, sorcery, magic, and conjuring. Wizardry involves the calling and control of supernatural creatures who then aid the party. Sorcery is the creation of illusion and heightened awareness. Magic gives common objects an additional power. Conjuring allows the user to create objects and affect physical items. The most potent of all mages is the archmage. Any mage may become an archmage, regardless of his original magic mastery, but it takes knowledge of all seven levels of spells in all four classes to achieve this powerful state. The attainment of archmage status is a goal that players should try to achieve with their mage, but we can tell you (with good authority) that the trail is steep and hard, and it is bound to take hundreds of playing hours to achieve if characters are started from scratch.

To create your characters, the computer first asks you to select a race; a die roll is then generated. With 18 as the highest point attribute, assignments of a numeric value to Strength, Intelligence, Dexterity, Constitution, and Luck are made by the computer. You can ask for another roll if the computer's roll is not satisfactory, and may continue to do so until a set of attribute assignments meet with your satisfaction. Once you've agreed on the distribution of points, the character should be saved to disk.

A second method involves a utility program found on the *Bard's Tale* program disk that allows you to convert your *Wizardry* or *Ultima III* computer game characters to this environment. These characters should remain in one piece longer than those generated from scratch, although such matters as the special weapons and experience they have accumulated within their native game environs are usually lost when transferred to *Bard's Tale*. For heaven's sake, use only backed-up characters for this process. As we had *Wizardry III* and *Ultima III* characters of extremely high level, we were able to get off to a running start in *Bard's Tale*, but not without a great deal of concern for our valorous participants.

The fact that we met and defeated numerous encounters on the streets of Skara Brae is only a small part of the total quest. Skara Brae is a town of some size, and every street and building is graphically displayed onscreen in a window and must be searched. The hunt ultimately reveals the locations of the inns, temples, dungeons, and castles that are the primary targets of your quest. By utilizing a map of Skara Brae, found on the inside cover of the program's packaging, one learns how

• SIN & VICE! • GRAFT & CORRUPTION! • ROBBERY & RICHES!

# GET YOURS IN \$IN CITY!

What more fun setting could there be for a game than the greatest symbol of western vice: Intrigue and exploitation of the 19th and 20th centuries, **Shanghai, China**? As a national trading baron you must build your trading empire and fortune (using the means available) and then get out alive to enjoy it!

All of the elements from the mounted, color game board to hedonistic human nature are there to bring the most fun you've found in a game box. Easy to learn and riotous to play, Sin City awaits you in **Shanghai Trader**.

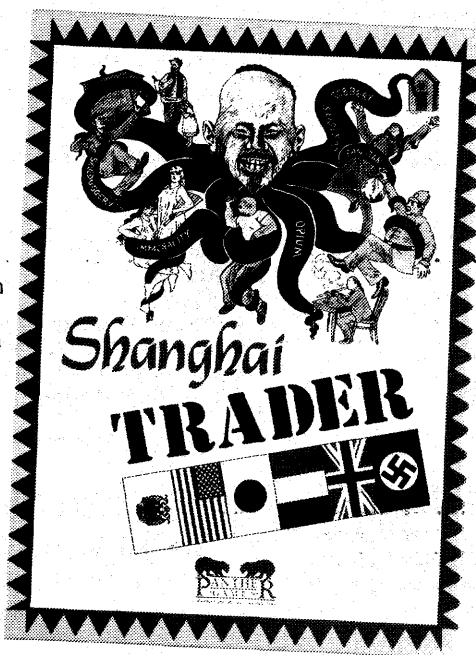

Another quality product from PANTHER GAMES of Australia. Now available in better game stores everywhere.

• LOAN SHARKING! • ASSASSINS! • THUGS! • MUGGERS! • OPIUM! • POVERTY & EXPLOITATION! • COOLIES & COURTESANS! • ESCAPE! • RACKETS & GANGS! • TONGS! • GANGS! • TONGS! • GANGS! • SPIES! • CURRENCY TRADING!

to maneuver through the alleyways, thoroughfares, and courtyards of the town. This takes some doing, as the graphics displayed in the window in the upper left-hand corner of the screen do not look like the images on the map. Perseverance leads you to such locations as the inn on Rakir Street, where a trip to the cellar for some fine old wines gives you more than you bargained for; to the temple in the Gran Plaz, where Mad Dogs find no Englishmen; to the Review Board a couple of doors south of Blacksmith Street, where you can trumpet your success at reaching a new level; and, to Grey Knife and Serpent Streets, where one's energies can be recharged (for a price).

There are several inns and taverns located throughout Skara Brae that are quite important, especially for recharging your bard's singing voice. The bartenders in these precious pubs have loose tongues if your party has loose change. The temples are ideal locations for party respites, as the priests can heal all sorts of injuries, including total reanimation of the dead. This does cost gold pieces, so one should be prepared by accumulating wealth for these little emergencies. The Review Board, when found, becomes an active stop on your list of buildings to enter, for here your accumulation of experience points leads to higher character levels. Once you've reached a new level, magic-users who wish to learn that levels spells must pay for the privilege — well worth any cost!

One of the shortcomings of this game is that you *must* have your party return to the Adventurer's Guild to save the game and to have your character's gain experience, wealth, and possession of found property. Until the party gains stature in levels, wandering too far away from the Adventurer's Guild can be fatal! If you're starting play from scratch, we recommend only a day's adventure, staying within a one-block radius on Rakir Street, thus slowly building your characters to a level where the search can be initiated for The Review Board. Without the Review Board granting increments in levels for your characters, the characters don't have a hope of finishing this quest. As the experience levels increase, as your mages gain new and more powerful spells, the search radius away from the Adventurer's Guild can be increased.

The second drawback to the game is its use of combat. Without question, *Bard's Tale* is a bloody game of kill or be killed. There is no choice in this matter; this is the way experience, gold, and the occasional good weapon or object are found. You can't sit and talk to Mangar's goons to see if you can talk them out of an attack, nor can you bribe them to go away. When an encounter is signified (which may involve 99 creatures in ranks four deep!), it's off to war you go, ho-ho. You don't even get the option of running for your life — and considering some of the beasties you'll

encounter, that's too bad. In many cases, the level of your experience is not enough to counter the power of the adversary, and running away to fight another day would have been an excellent decision.

When an attack is signaled, you select from the following: Attack Foes (attack the enemy), Party Attack (attack a member of your own party who may have turned to the dark side), Defend (reduce the odds you'll be hit in this melee round, though you can't attack, too), Use An Item (bring a magic item into play against the beasties), Bard Song (get that tune trilling from your bard's lips), Cast A Spell (your mages should be in the back row, away from the flashing swords, so they can utter their spells against your foes), and Hide In Shadows (something your Rogue will be very adept at accomplishing). If fighting a large group of Mangar's minions, the attacking/defending/spell-casting routine could go on for some time. In the final dungeon (in the castle); there is an area on the third floor in which you confront 496 berserkers — a fate we wouldn't wish on anyone! The battle took nearly two hours to complete!

There are three dungeons. The first is found in the southern reaches of Rakir Street, but even this dungeon requires characters of some stamina. There's a statue on Rakir Street that must be defeated before you can find the proper door to a wine cellar that develops into a four-level dungeon. The second dungeon

involves a temple in the Gran Plaz, with some of the nastiest souls you'll ever want to meet. And the final dungeon isn't a dungeon at all, but three floors of a castle — and the castle's dangers will leave you cringing for many nights to come. There are numerous traps, areas where spells have no effect, teleportation hexes, portals up and down, smoke-filled rooms, and denizens that'll put your best to the test.

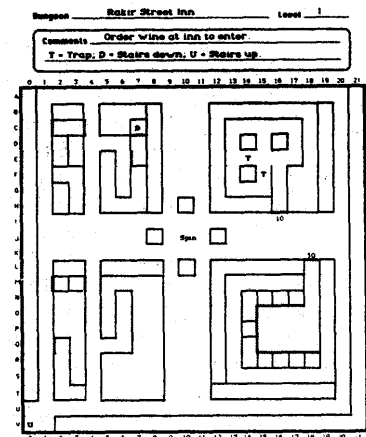

A map is shown here of the first floor of the first dungeon, and consists of a total of 484 square-shaped "hexes." In many instances, the map sides wrap around; when one enters the hex at A21, for instance, and moves one more square west, he ends up at A0. The map is courtesy of a friend of ours, Steve Schwartz, who designed it

## IT CAME FROM OUTER SPACE. IT ASKED FOR A DATE.

**Space Teenyboppers. Alien Low Riders, Weird Science. 5th Dimensional Computer Nerds. Twelve Armed Cheerleaders. Plutonian Punkers. Occasional Normal People. All invading your planet in a guaranteed Vice-Principal's nightmare called TEENAGERS FROM OUTER SPACE. T.F.O.S. is a roleplaying game for people who can't get enough strangeness in their daily lives, filled with gonzo humans, near-humans, and downright weirdies who conquer your local high school looking for a good time and new MTV videos. It's like all the horrible "summer fun" films you ever saw crammed into one. All wrapped in a game system so fun, so simple, your mother could play it.**

**TEENAGERS FROM OUTER SPACE. Are you ready for it? It's ready for YOU.**

**TEENAGERS FROM OUTER SPACE™ is a very weird game from the very weird guys at**

**R. TALSORIAN GAMES INC.**

**Box 2288, Aptos, CA. 95001**





on a Macintosh. The map is suited for most computer adventure games.

Some pretty good stuff is yours to be had, once you've defeated your foes. The deeper the level, the better the goodies. You'll find weapons made of adamant (a magic metal), mithril, and diamond. There'll be musical instruments like mandolins and harps for your bard, normal armors such as plate or chain mail, and figurines which can be brought to life to aid your group.

Without doubt, *Bard's Tale* is one of the most complex adventures available for the home computer. When starting, the possibility of becoming bored with fight after fight does exist, but continue with the game, as it gets far more interesting, especially when you start finding those fantastic items that'll aid your quest. Above all, *save your game!* As this can only be accomplished at the Adventurer's Guild, know where the guild is located in relation to your activities at all times; don't overstep the bounds of reason. Once you've saved your game, back up your characters! In this manner, should you eventually lose the big one and find all of your party dead, you can start afresh from the point where your characters were last backed up. *Bard's Tale*, a game of high adventure, whose two major drawbacks diminish in scope as you gain experience, is one we recommend for your software library. *Bard's Tale* is available for the Commodore 64/128 (\$39.95), Apple II series (\$44.95), and Commodore Amiga (\$49.95). There is also a *Bard's Tale* Clue Book available for a price of \$12.95. *Bard's Tale II*, the fantastic sequel, will be released before Christmas for the Commodore 64/128.

As for other games and programs that we recommend for software gaming, the following have caught our eye. Hopefully, in future columns, we'll be able to investigate most of these titles. As an aside, there is one new product from Electronic Arts that has, so far, been stunning in its presentation and play. This is a science-fiction adventure entitled *Starflight*, and the scope of its involvement is awesome, span-

ning star systems, planets, life forms, and spacecraft. The program's two main goals are to gather information and generate revenue. From what we've experienced in our first two days with this game, the landing sequence on planets is really first-rate, and several more hours of play are necessary to even begin to understand how expansive this entire product is. This program is for the IBM PC.

#### Recommended products

*Tass Times in Tonetown* is a graphic adventure game in which you must find your grandfather, who has disappeared into another dimension. This one is truly bizarre. *Tass Times in Tonetown* is from Activision, 2350 Bayshore Road, Mountain View, CA 94043 (telephone: (415) 960-0410). Versions exist for: Commodore 64/128 (\$34.95); Apple II series, IBM micros and PCjr, and Tandy 1000 (\$39.95); and, the Commodore Amiga and Apple Macintosh (\$44.95). An Atari ST version is expected to be released soon.

*Airheart* is a new 3-D adventure game written by Dan Gorlin, the creator of *Choplifter!* It includes robot antagonists and realistic flight action. This game is available from Broderbund Software, 17 Paul Drive, San Rafael, CA 94903-2101 (telephone: (415) 479-1170). Versions exist for the Apple II series (\$34.95).

*Archon II: ADEPT* is the sequel to the award-winning *Archon* adventure/strategy game, which has now been released for the Commodore Amiga computer. This new translation features stereo sound and advanced graphics. *Archon II: ADEPT* is a product of Electronic Arts, 1820 Gateway Drive, San Mateo, CA 94404 (telephone: (415) 571-7171). Versions of this program have been produced for the Commodore 64/128, Commodore Amiga, Atari 800 XL, and Apple II series (\$34.95).

Also redesigned for the Commodore Amiga is Stuart Smith's *Adventure Construction Set*, wherein the user can create his own complex and graphically appealing adventure game. You can create your own digitized sound effects, and the graphics you generate are stunning. The offering comes with a built-in adventure

as well. This program is also from Electronic Arts, and has a price of \$39.95. The game is also offered on Apple II versions (\$49.95) and for the Commodore 64 (\$39.95).

One of our personal favorites is the newly released *Ogre*, the computerized translation of Steve Jackson's classic boardgame. *Ogre* requires strategy as, in two-player mode, the awesome *Ogre* Cyber-tank battles an assortment of armor and infantry in an attempt to overrun the opposing command post. Set in the nuclear wastelands of the future, this is another winner from Electronic Arts. *Ogre* is for the Apple II at \$39.95. Also, the company has now released an IBM micro version of *Ultima IV*, the largest computer adventure game ever attempted. This one is absolutely fantastic!

The first interactive gothic mystery for computer games has made its debut. Entitled *Moonmist*, this game casts the player as a famous sleuth trying to solve a mystery involving murder and ghosts. *Moonmist* is a product of Infocore, 125 Cambridge Park Drive, Cambridge, MA 02140 (telephone: (617) 492-6000). Versions exist for the Apple II series, Apple Macintosh, Atari XL, XE, and ST computers, Commodore 64/128 and the Amiga, and IBM micros (\$39.95).

*Balance of Power*, by Chris Crawford, is a truly entertaining and thought-provoking simulation of world geopolitics which involves the player in a quest to prevent a worldwide nuclear holocaust, while promoting either the U.S.A. or Russia to world prominence. This is a marvelous program that everyone should experience at least once. This offering is a product of Mindscape, Inc., 344 Dundee Road, Northbrook, IL 60062 (telephone: (312) 480-7667). *Balance of Power* is for IBM micros and the Apple Macintosh (\$49.95).

Also from Mindscape comes *Uninvited* — a truly horrifying adventure game and mystery that'll leave you shivering in the dark. You find yourself alone in your car after a wreck — but where is your brother? Perhaps the spooky mansion contains the answer! This program is for the Apple Macintosh, with digitized sound effects and graphics that contain clues!

Both *Roadwar 2000* and *Shard of Spring*, from Strategic Simulations, 1046 North Rengstorff Avenue, Mountain View, CA 94043 (telephone: (415) 965-1353), are on our list as hit programs. *Roadwar 2000* follows a futuristic scenario of a post-nuclear age in which survival depends upon a good set of wheels (19 vehicle types, no less). This product is available for the Apple II series and the Commodore 64 (\$39.95). *Shard of Spring* is a new fantasy game that involves you in zoom combat and a quest to rescue a portion of the Lifestone from the evil Siriadne. This program is available for the Apple II series and the Commodore 64 (\$39.95).

## From TSR, Inc.



ORCUS LIVES . . .

IN H2: THE MINES OF BLOODSTONE

TSR Inc.  
PRODUCTS OF YOUR IMAGINATION!

An ADVANCED DUNGEONS & DRAGONS, AD&D, PRODUCTS OF YOUR IMAGINATION, and the TSR logo are trademarks owned by TSR Inc. ©1986 TSR Inc. All Rights Reserved.



# JUDGE DREDD

## THE ROLE-PLAYING GAME

### YOU ARE THE LAW IN THE 22ND CENTURY

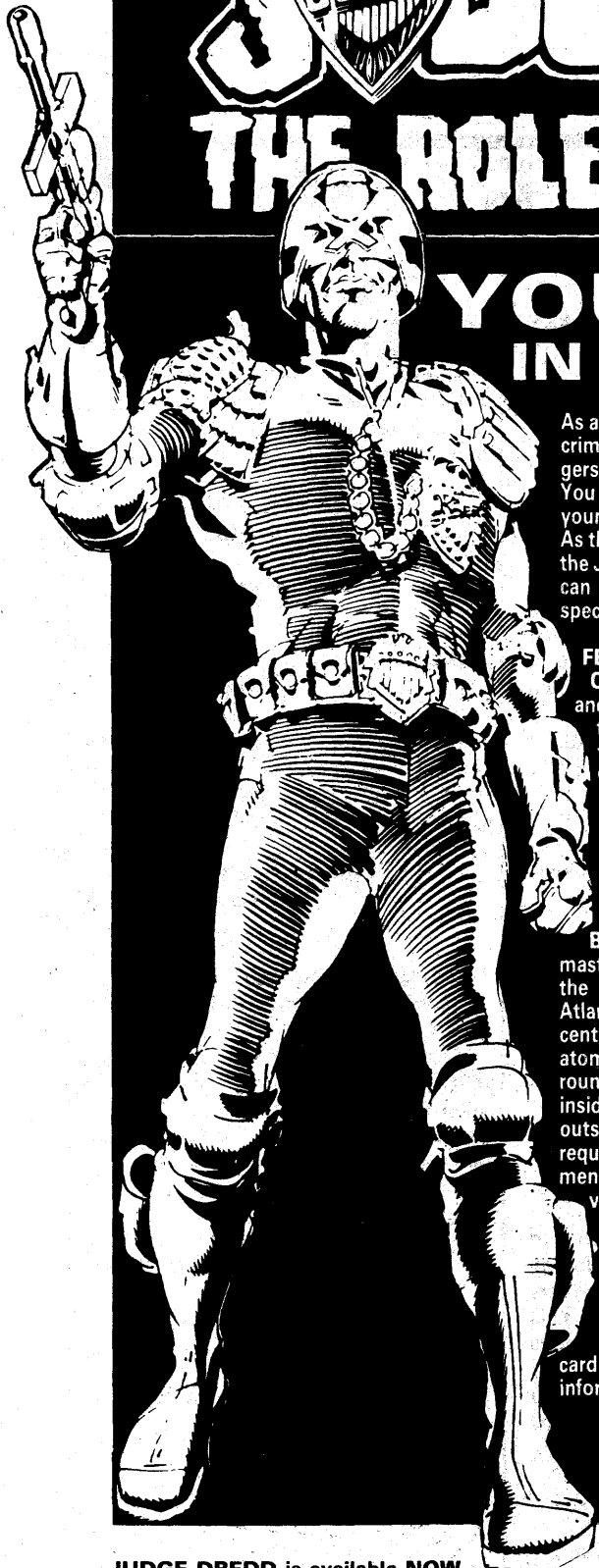

As a Judge you strive to enforce justice in a city of 400 million people, a city riddled with crime and violence; you face a whole series of dangers, from deadly mutants to organ-leggers, from careless litterers to psychopathic futsies.

You are a one-man judge, jury and executioner in a state ruled by the Judges. You'll work your way from a rookie right up to an experienced lawman.

As the Gamesmaster you will present your players with a series of new situations, using the Justice Department's computer to relay information to the Judges on the street. You can provide back-up services such as laboratory analysis, comprehensive records and special equipment.

#### FEATURES:

**Character generation** - enables you to begin play as a rookie or fully fledged Judge, and provides means of generating a character of any level. Innovative skill characteristics include technical skill, street skill, etc. Specialist abilities allow you to develop your character - there are 62 abilities in total! Generation includes full details of weaponry and equipment; the Lawgiver gun, the Lawmaster bike, etc.

**Games System** - based on the popular percentile system that obviates the need for endless dice rolling. Easily learned but detailed mechanics, with characters' actions distributed into phases so there is never any doubt as to who is doing what and when. Full rules for armour, damage and its effects.

**Background** - provides the players and gamesmaster with a thorough guide to the Mega-City, the huge conurbation that sprawls across the Atlantic seaboard of 22nd century America. Since the atomic wars it has been surrounded by radiation desert. Life inside the Mega-City is harsh, life outside impossible. Harsh times require harsh laws and tough men to enforce them. Rules are provided for creating all of the strange inhabitants of the future, as well as city blocks, vehicles, robots, etc. JUDGE DREDD - The Role-Playing Game includes two scenarios with play sheets and cut-out card characters, and 200 pages of information!

**GAMES  
WORKSHOP**

JUDGE DREDD is available NOW from all good games stores or directly by mail for \$16.00 from: Games Workshop U.S., 9110F Red Branch Rd., Columbia MD 21045. Tel. (301) 9640262. Add \$1.50 for postage and handling (for total orders less than \$25.00). Maryland residents add 5% sales tax. Payment must be in U.S. funds. Allow four weeks for delivery.

from all

### JUDGEMENT DRY

The first all-action scenario for JUDGE DREDD. Only \$7.00!  
JUDGE DREDD miniatures available from CITADEL.  
Write for full lists to Games Workshop U.S.  
JUDGE DREDD © 1986 IPC Magazines Ltd.

**NEW!**



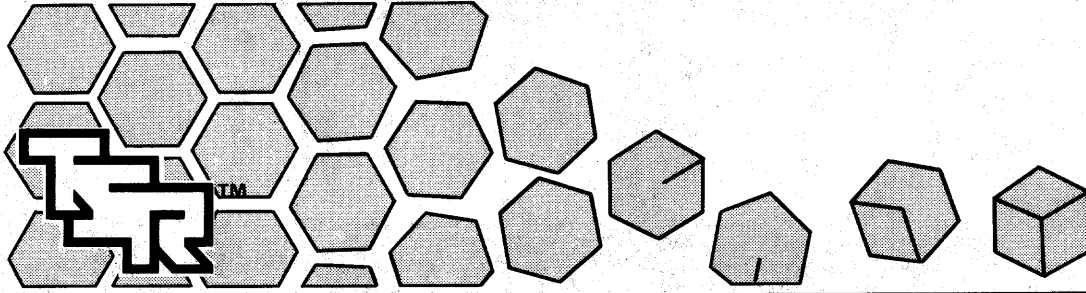

# P R E V I E W S

## NEW PRODUCTS FOR JANUARY 1987

### H2 The Mines of Bloodstone

#### AD&D® Game Adventure

by Michael Dobson & Doug Niles

Unparalleled high-level dungeon excitement in the first adventure that includes the *Dungeoneer's Survival Guide* rules! After defeating the armies that menaced the small mountain village of Bloodstone (in H1, *Bloodstone Pass*), the heroes must uncover the secret menace in the depths of the bloodstone mines. We won't tell you who's down there, but he is best known for this wand he carries...heh, heh.

**Suggested Retail Price: \$8.00**  
**Product No.: 9168**

### DA2 Temple of the Frog

#### D&D® Blackmoor Game Adventure

by Dave Arneson and David Ritchie

The infamous "Temple of the Frog" scenario from the original D&D® Blackmoor Supplement comes to life in a ferocious and deadly high-level adventure by D&D® game co-creator Dave Arneson! Deep in the Great Swamp lurks Steven and his strange brotherhood of monks. . . and few who visit ever return alive.

**Suggested Retail Price: \$8.00**  
**Product No.: 9175**

### N4 Treasure Hunt

#### AD&D® Game Adventure

by Aaron Allston

An adventure for *0-level characters!* That's right...zero-level player characters! Can you survive a mad treasure hunt across the grounds and buildings of an abandoned manor house that has become a battleground in a war between goblins and orcs? A uniquely weird challenge for truly skilled players—don't miss it!

**Suggested Retail Price: \$8.00**  
**Product No.: 9185**

## NEW PRODUCTS FOR FEBRUARY 1987

### X12 Skarda's Mirror

#### D&D® Game Adventure

by Aaron Allston

Marauding bandits have repeatedly raided the countryside, and a mage is gallantly pursuing them, only to accidentally stumble upon their hideout and a strange mirror the bandits have stashed there. An investigation is in order when both the bandit leader and the mage disappear into the mirror's unknown realms!

**Suggested Retail Price: \$8.00**  
**Product No.: 9188**

### OA3 Ochimo, The Spirit Warrior

#### An AD&D® Oriental Adventures Module

by Jeff Grubb

An unearthly spirit haunts a colony in far Eastern lands. The heroes must find the spirit and defeat this dangerous warrior from battles past.

**Suggested Retail Price: \$8.00**  
**Product No.: 9195**

### GW7 Beta Principle

#### GAMMA WORLD® Game Adventure

by Bruce Nesmith

A visit to the remains of an old amusement park sets the stage for an exciting adventure to the legendary skywalking city of the ancients. This module continues the campaign series introduced in GW6 Alpha Factor.

**Suggested Retail Price: \$8.00**  
**Product No.: 7510**

### CHEERS® Game

#### Family Game

Based on the Emmy Award-winning CHEERS® television show! The famous

Boston bar "where everybody knows your name," provides the setting for fans and would-be fans to play their favorite CHEERS® character and to engage in a game of zany notes and quotes. Can you meet the challenge of "Normie's Olympics"?

**Suggested Retail Price: \$19.95**  
**Product No.: 1028**

CHEERS® and © of Paramount Pictures Corp.

## AMAZING® SCIENCE FICTION STORIES

### The Wonder Years 1926-1935

Edited by Martin H. Greenberg

This collection of classic science fiction is the best from the 1926-1935 issues that include stories from such science-fiction greats as H.P. Lovecraft, John W. Campbell, and Edmond Hamilton.

**Suggested Retail Price: \$3.95**  
**Product No.: 8115**

### SNARFQUEST: The Book

#### DRAGON® Magazine Special

by Larry Elmore

A comic quest for wealth, power, and all that good stuff, this special magazine gathers three years of the popular fantasy cartoon strip which has appeared in the pages of DRAGON® Magazine. Created by one of the most noted fantasy artists in America.

**Suggested Retail Price: \$9.95**  
**Product No.: 8118**

Unless otherwise noted:

® denotes registered trademarks owned by TSR, Inc.

™ denotes other trademarks owned by TSR, Inc.

©1986 TSR, Inc. All Rights Reserved.



# The Quest is Over

At last, you have found the mighty source for authentic Fantasy-Wear apparel. The Fantasy-Wear line comes alive with all new high quality screen printed designs on a selection of durable, heavy-weight T-Shirts and sweatshirts. Order your Fantasy-Wear T-Shirt or sweatshirt now while supplies last. Finally, it is your chance to wear the mark of fantasy and adventure.

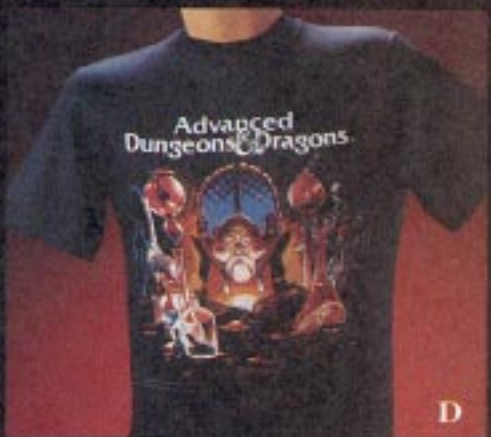
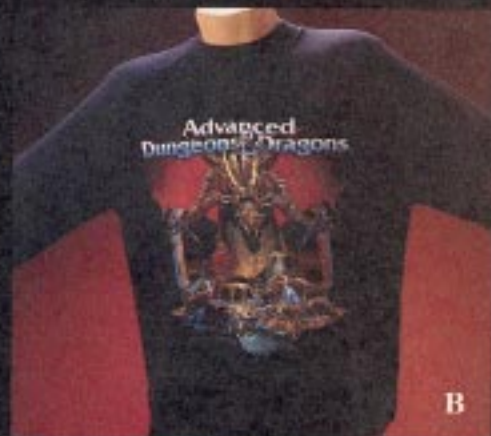

## FANTASY-WEAR ORDER FORM

PRINT OR TYPE ALL INFORMATION BELOW

Name \_\_\_\_\_  
 Address \_\_\_\_\_  
 City \_\_\_\_\_ State \_\_\_\_\_  
 Zip \_\_\_\_\_ Phone \_\_\_\_\_

Method of payment (check one)  Check  Money Order  
 Visa  Mastercard **DO NOT SEND CASH**

CREDIT CARD NUMBER \_\_\_\_\_ EXP. DATE \_\_\_\_\_

Signature (as shown on credit card) \_\_\_\_\_

Fill out your completed order. Indicate size and quantity of garments desired. Check and Money Order made payable to:  
**Fantasy-Wear, P.O. Box 1443, Waukesha, WI 53187-1443**  
 Offer good only in U.S. Allow 4-6 weeks for delivery.  
 Only original order form or photo copy of form will be accepted.  
**PLEASE DOUBLE CHECK YOUR ORDER TO AVOID DELAY. THANK YOU.**

GARMENTS PRINTED BY HOLOUBEK, INC.

ADVANCED DUNGEONS & DRAGONS, DUNGEONS & DRAGONS, DRAGON, and DRAGONLANCE are trademarks owned by and used under license from TSR, Inc. ©1988 TSR, Inc. All rights reserved.

Design Description	Garment	Indicate Quantity in Appropriate Boxes				TOTAL
		Small	Medium	Large	X-Large	
<b>A</b> Dragon Lance	Hooded Sweatshirt					\$
	Crew neck Sweatshirt					\$
	100% cotton T-shirt					\$
<b>B</b> A.D. & D. Dragon	Crew neck Sweatshirt					\$
	100% cotton T-shirt					\$
<b>C</b> A.D. & D. Marvelous Magic	Crew neck Sweatshirt					\$
	100% cotton T-shirt					\$
<b>D</b> A.D. & D. Last Spell	Crew neck Sweatshirt					\$
	100% cotton T-shirt					\$
Pricing Information					Subtotal	\$
10-50 Black Hooded Sweatshirt		\$16.95	Wisconsin residents add 5% Sales Tax			\$
10-50 Black Crew Neck Sweatshirt		\$14.95	Shipping/Handling			\$2.00
100% Cotton Black T-shirt		\$9.95				
<b>Adult Sizes Only</b>						<b>TOTAL</b> \$



# The Marvel®-Phile



by Jeff Grubb

A question that often comes up is how it's determined who goes into this column. In general, the heroes chosen are individuals who are interesting, unique, and not known from any existing MSH projects. That's why the Inhumans™ finally showed up a few issues back, then Terminus™. Most of the time I go through the pile of correspondence, listening to the voice of the people, and then make a suggestion to Roger Moore.

At the suggestion for this 'phile, Roger Moore (the real one) looked up at me in mild surprise. "Killer Jugglers?" he asked, "I thought the April Fool's issue was months off."

"You wanted the Unlimited Class Wrestling Federation™ for that issue," said I, collapsing into a comfy chair in his audience hall. "No, I'm talking about a serious

## Caught in the Crossfire™

team of bad-guys — guys who would give Cap™ or Hawkeye™ a hard time, maybe even Spider-Man™. They first appeared as a team rescuing a CIA-agent-turned-criminal named Crossfire™. Crossfire had a plot to turn heroes against each other by a type of sonic hypnotism."

"Sounds interesting," says Roger, cleaning his Rambo water pistol. "You give me Crossfire, I'll let you throw in the Death-Throws™ as well."

And there you have it. Are decisions at General Motors made like this?

individual must make another Psyche FEAT to maintain control). The range of this device is only two areas, however, as it is still in prototype form.

**TALENTS:** Crossfire has Martial Arts B and E, and is a skilled Marksman. He also has the Detective/Espionage talent and the skills of Computers and Ultrasonics.

**CONTACTS:** Crossfire has a number of contacts in the criminal and espionage fields. He also has contacts with a group of scientists specializing in brainwashing and mind control.

### CROSSFIRE™

**William Cross**

F	RM (30)	Health: 90
A	RM (30)	
S	GD (10)	Karma: 60
E	EX (20)	
R	EX (20)	Resources: TY (6)
I	EX (20)	
P	EX (20)	Popularity: -3

### KNOWN POWERS:

**Enhanced Senses:** Crossfire lost his left eye and ear, and 85% of the hearing in his right ear, as the result of an explosion. He has since replaced his lost sight by an infrared imaging device that allows him Excellent normal vision and Excellent-intensity night vision. He also wears an audio sensor that provides Incredible-rank hearing; the sensor may be turned down to provide Incredible resistance to sonic and sound-based attacks.

**Uniform:** Crossfire's uniform provides Good protection from physical attacks and Excellent protection from heat and energy attacks. The outfit has a number of pouches and compartments containing items like gas masks, surveillance bugs, and single-shot weapons (treat as cheap handguns).

**Mind-Control Equipment:** Crossfire has developed a form of mind-control device that relies on applied ultrasonics, sound waves of frequencies above normal detection (Remarkable or better rank in hearing or detection required to perceive). These sonics have Monstrous mind-control power and fill listeners with intense hatred and violence. Those that fail a Psyche FEAT against this barrage will attack everyone within range until the device is shut off (if the device is reactivated, the

**Crossfire's story:** William Cross became an agent of the CIA with an eye toward using his training to his own eventual benefit. He specialized in information gathering and mind control, using ultrasonic devices. He left the agency and, as Crossfire, began forming his own mercenary agency. An explosion planned by a rival group cost him his sight in one eye and most of his hearing, but Cross replaced these lost senses with cybernetic improvements and took revenge on his attackers.

Soon, Crossfire became concerned with the potential threat of powerful heroes, and began to research methods to eliminate that threat. Refining the methods he helped develop at the CIA, Crossfire created a prototype brainwashing device which would cause the super-human hero community to destroy itself. This prototype was itself destroyed by the Thing™ and Moon Knight™.

To build his second prototype, Cross used components from his cousin Darren's company, Cross Technologies™, where the hero Hawkeye was employed at the time. Considering Hawkeye a weak link in the heroic community, Cross kidnapped him and the former S.H.I.E.L.D.™ agent Mockingbird™ and subjected them to the sonics, forcing them to fight. Hawkeye sustained a permanent hearing loss during this battle. The pair escaped, destroyed Cross's machine, and placed Cross under arrest.

Cross was rescued from police custody by the Death-Throws, a group of criminal jugglers. Two of the groups members (Oddball™ and Bombshell™) had previously worked for Cross, and the group agreed to break Cross out in return for a sizable fee. When the group discovered Cross had no cash (his machines were impounded and his ties with Cross Technologies cut), they

decided to use Cross as bait to lure Hawkeye and Captain America™ into a trap. Cross and the Death-Throws are currently in police custody.

## THE DEATH THROWS™

Total Karma Pool: 212

### RINGLEADER™

Charles Last

F	GD (10)	Health: 56
A	RM (30)	
S	TY (6)	Karma: 40
E	GD (10)	
R	GD (10)	Resources: Good (10)
I	EX (20)	
P	GD (10)	Popularity: -2



### BOMBSHELL™

Wendy Conrad

F	GD (10)	Health: 50
A	EX (20)	
S	GD (10)	Karma: 36
E	GD (10)	
R	TY (6)	Resources: Good (10)
I	EX (20)	
P	GD (10)	Popularity: -3

### ODDBALL™

Elton Healey

F	TY (6)	Health: 52
A	RM (30)	
S	TY (6)	Karma: 46
E	GD (10)	
R	TY (6)	Resources: Good (10)
I	EX (20)	
P	EX (20)	Popularity: -2

### TENPIN™

Alvin Healey

F	GD (10)	Health: 56
A	RM (30)	
S	TY (6)	Karma: 36
E	GD (10)	
R	TY (6)	Resources: Good (10)
I	GD (10)	
P	EX (20)	Popularity: -2

### KNICKKNACK™

Nick Grossman

F	EX (20)	Health: 66
A	RM (30)	
S	TY (6)	Karma: 26
E	GD (10)	
R	TY (6)	Resources: Good (10)
I	GD (10)	
P	GD (10)	





## POWERS:

*Ultimate Skill* — Juggling: (Okay, stop laughing, this is serious.) All of the Death-Throws are expert jugglers — all FEATS involving juggling are at the Unearthly rank. This includes the ability to throw weapons and catch objects as well.

Each member of the Death-Throws has his or her own special preference for juggled objects:

Ringleader is a master with the razor-sharp rings he carries on his belt. These rings inflict Good Throwing Edged Damage. Ringleader also has Leadership ability and is the team's leader and spokesman.

Oddball's specialty is juggling spheres, and normally he carries a small arsenal of hollow balls. These include:

\* Smoke balls (treat as smoke grenades);

\* Knock-out gas balls of Incredible intensity;

\* Acid balls of Excellent intensity;

\* Solid rubber balls that do Good Blunt throwing damage;

\* Spiked spheres inflicting Typical Edged throwing damage; and,

\* Fire balls doing Good fire damage.

Tenpin's specialty is with specially weighted bowling pins, normally worn on a special backpack. These weighted pins inflict Good Throwing Blunt damage or, if

lit, Excellent fire damage. The clubs have Typical material strength.

Bombshell specialized in explosives before joining the Death-Throws, and she receives a + 1CS when creating, rigging, or defusing explosive objects. She packs wrist-firing stun-bolts of Excellent-intensity stunning. She normally juggles armed explosives, such as grenades of Typical to Incredible damage; she pulls the pin on grenades in the last toss before throwing them.

Knickknack juggles objects of dissimilar shapes, such as a bowling ball, tomato, and meat cleaver, though he is equally good with a lead pipe, orange, and activated chain saw. His weapons inflict damage as Throwing Edged or Blunt weapons, according to type (a thrown chain saw inflicts Excellent Edged attack damage).

**Death-Throws' story:** Little of the origin of this group of costumed criminal jugglers has been revealed. The original group included organizer Ringleader, Oddball, Oddball's brother Tenpin, and Knickknack. While working separately for Crossfire, Oddball met Bombshell, found her a natural talent for the craft, and recruited her into the team.

The Death-Throws were soon contacted by Crossfire to spring him from jail. The

team rescued Cross from the authorities, then discovered that Cross had no money to pay for his rescue. After a debate, the group decided to use him as bait to lure Hawkeye and Captain America into a trap, afterwards ransoming the heroes. The Living Legend and Battling Bowman dealt with the team and the latter, along with Cross, are in police custody.

The Death-Throws stress teamwork more than any other villainous team, and maintain a snappy dialog with each other to go with their smooth movements. They are continually honing their skills as jugglers and more than willing to perform criminal acts for a price.

**NEXT:** "So," says Roger, laying back on his sofa as his assistant editor peeled grapes for him. "What next month — Mimes of the Marvel Universe®?"

"We did Black Bolt™ two months ago."

"Then what?"

"How about the Marauders™, straight from the Mutant Massacre?"

Roger choked on his grape.

See you in thirty.

Copyright ©1986. Marvel Comics Group. All rights reserved. Marvel, Marvel Universe, and all Marvel characters and the likeness thereof are trademarks of the Marvel Comics Group and are used with permission.

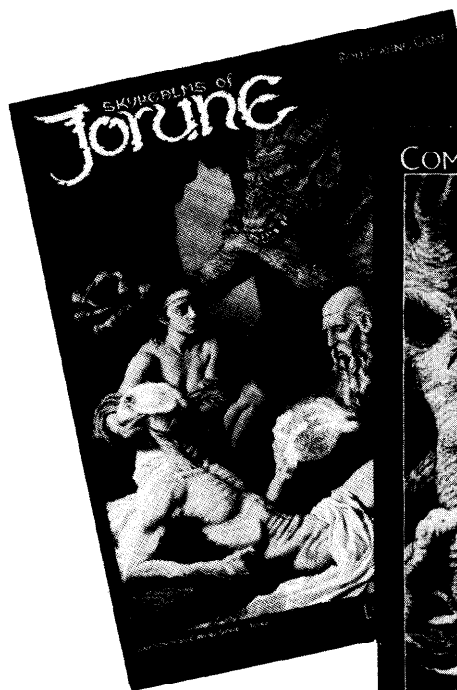

## ALL NEW!

### COMPANION JORUNE: BURDOTH

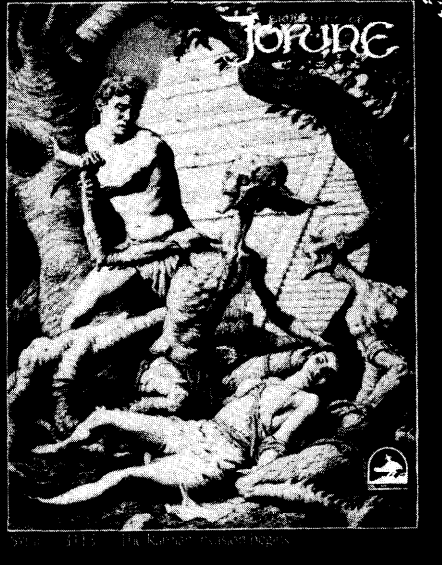

# SKYREALMS of Jorune™

**SKYREALMS of JORUNE** is complete role-playing on a complete world. The boxed edition contains four books—everything needed for play (besides dice). Three player-character races are offered to Jorune adventurers, though the necessary rolls for all other races are provided. Our character-sheets usher in a new age of playability; all percentiles for skills are listed, and are easily highlighted. With these sheets, Jorune's combat system is role-playing, and accurate, action-packed adventure is the result. An amazingly detailed encounters system, unique to Jorune, gives referees the foundations to build palpable Jorune adventures. A cultural and survival guide, written by sages and high-ranking Jorune officials, is included, as is an introductory Jorune campaign. All books are strikingly illustrated by Jorune's co-designer, Miles Teves. Maps included. **COMPANION JORUNE: BURDOTH** contains timelines, detailed histories, maps, illustrations, and in-depth descriptions of over 60 cities in Burdoth and Heridoth. **COMING SOON: COMPANION JORUNE: ARDOTH**, and a host of modules and other releases!

See your retailer for more information, or contact us directly. **BURDOTH:** \$9 - \$1 postage; **Boxed Edition** \$25 + \$1.50 postage. Allow 4-6 weeks for delivery. Free catalogue and/or orders: SKYREALMS • 526 Mission • Santa Cruz • CA • 95060. 408-429-9938.

## LEAVE YOUR WORLD BEHIND™







# Steve Jackson Games

## Invites You to Spend an

## Old Fashioned Christmas . . .



### . . . In the Arena

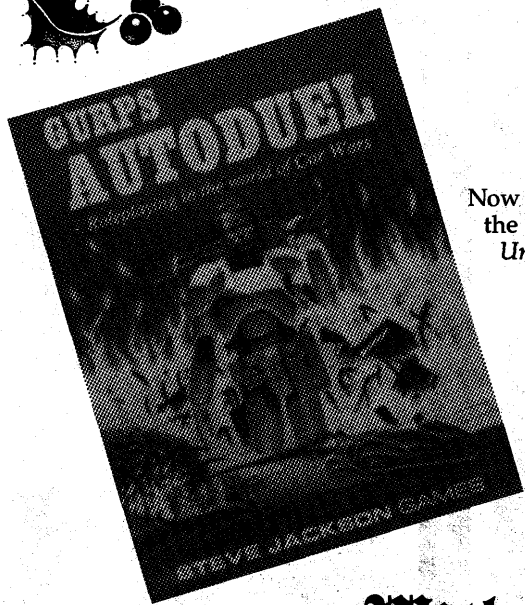

Now the top two games from Steve Jackson come together! With *GURPS Autoduel*, the fast action, future world of *Car Wars* becomes part of *GURPS*, the *Generic Universal RolePlaying System*. And that's just the beginning.



### . . . With a Sorcerer

*GURPS Fantasy* adds the wonder of magic to *GURPS* with 300 spells to choose from. But it doesn't end there. New characters from elves to dragons are covered in this rules supplement for the most comprehensive roleplaying game ever made.

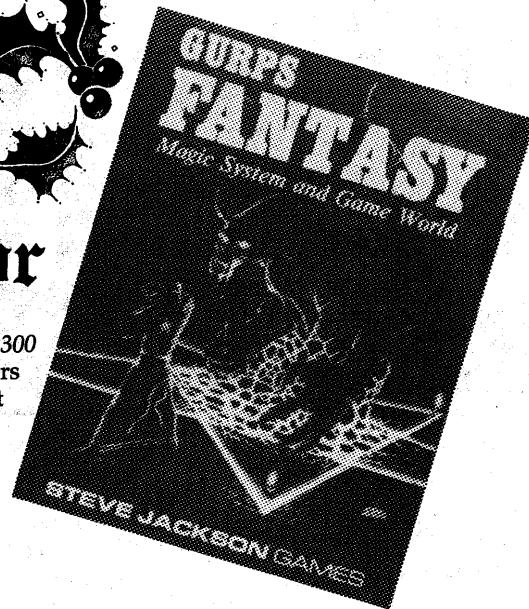

### . . . On the Battlefield



*Ogre* scenarios will now be limited only by your imagination — because the reinforcements have arrived! Need more units for the war? A larger battlefield? The *Ogre Reinforcement Pack* provides two extra full-color geomorphic maps (from *GEV* and *Shockwave*) and four full sheets of counters, including every unit ever published for the game. And, of course, brand new scenarios to tax your strategies to the limit.

Look for these products at your favorite hobby store or order them direct from us. *GURPS Autoduel* and *GURPS Fantasy* are \$10.50 each. *Ogre Reinforcement Pack* is \$5.50 each. Price includes postage and handling. Send your request along with a check or money order to:

**STEVE JACKSON GAMES**

Box 18957-D

Austin, TX 78760

*Car Wars*, *Autoduel*, *Ogre*, *GEV* and *Shockwave* are registered trademarks of Steve Jackson Games Incorporated. *GURPS* is a trademark of Steve Jackson Games Incorporated. All rights reserved.

# Doctor Who?

William Hartnell  
Photo courtesy of Lionheart Television International, Inc.

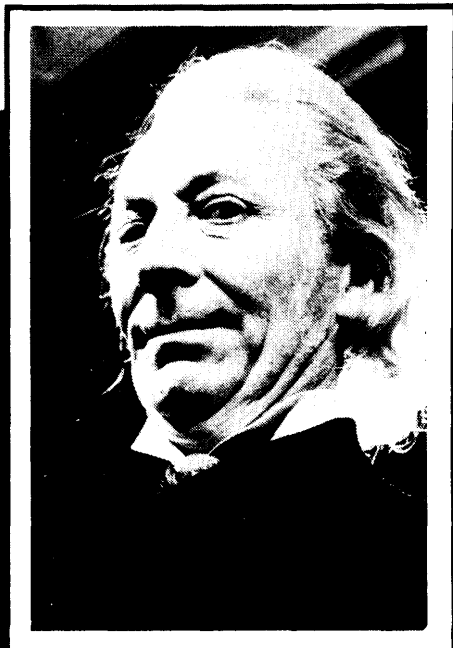

I

Patrick Troughton  
Photo courtesy of Lionheart Television International, Inc.



II

Jon Pertwee  
Photo courtesy of Lionheart Television International, Inc.



III

by Margaret Weis and  
Michael P. Bledsoe

Copyright ©1986 by FASA  
Corporation

One of the great mysteries of life that mankind has wrestled with since the dawn of his existence is death. It seems a terribly unfair, not to say downright wasteful, scheme of things. Just when we finally reach an age when we have gained wisdom and maturity, we are met by the men in the white business suits who lead us to that great escalator in the sky, mournfully reassuring us on the way that all is well because we have a piece of the rock.

There must be a better way, we tell ourselves. So, when we learned of the marvelous powers of the Gallifreyans, who have the ability to regenerate their bodies up to twelve times, we regarded them with undisguised envy.

Unfortunately, we have since learned that nothing is ever obtained without paying a price. For over twenty years, we

have been eager witnesses to the Doctor's adventures in both time and space. We have watched him battle countless evildoers, ranging from villains that resemble deadly garbage cans to monstrous broccoli. We envy him his charm, his scarf, his lovely Companions, his screwdriver, and his mechanical dog. Most of all, we envy him his various lives and longevity.

But should we? When it comes right down to it, after witnessing all the problems and headaches involved in regeneration, does that short, placid trip on the escalator really look so bad?

## Gallifreyan regeneration

Gallifreyans possess the ability to regenerate their bodies, if they either grow old or sustain so much damage that life is difficult to maintain. This is not something that can be done with the ease of buying a new sweater, however. Although regeneration is an inborn talent of the Time Lords, many have difficulty with the process, for it takes both strong intuitive and mental powers in order to exercise control of it.

When regeneration occurs, the body becomes comatose. A greenish white glow covers the skin. The body appears to melt like soft wax, reforming itself into a new individual with a completely different physical appearance. Following this, the new physical form must be allowed to gel, a process that takes 10-60 minutes. Then, an electroencephalic jolt flows through the body. The eyes open, and the comatose state ends.

Despite the fact that the Time Lord's new body is now completely operative and functional, a Time Lord generally undergoes a period of readjustment during which time the mind must accustom itself to its new environment. Certain Time Lords — those with exceptional control — have no difficulty with this period. Others, however, experience radical personality shifts. In rare cases, the personality, never stabilizes.

Most of us have trouble enough coping with one personality. The thought of managing one while remembering five others is mindboggling. Those people role-playing the Doctor in FASAs DOCTOR WHO game

## Six special incarnations for the DOCTOR WHO game

Tom Baker  
Photo courtesy of Lionheart Television International, Inc.



# IV

Peter Davison  
Photo courtesy of Lionheart Television International, Inc.



# V

Colin Baker  
Photo courtesy of Lionheart Television International, Inc.

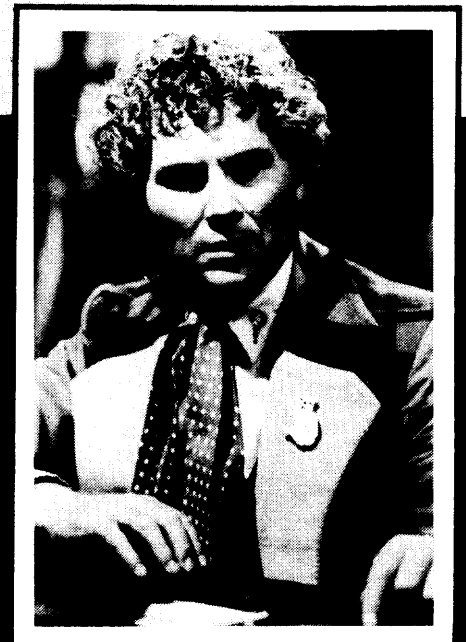

# VI

can bring an interesting depth to their characters by utilizing and understanding the phenomenon of regeneration and how it has affected the various incarnations of the Doctor. In this article, we provide a brief history of the Doctor throughout his six incarnations, provide corrected stats for all six Doctors, and explore the varying personalities of each.

### The Doctor, I

In 101,177 TL, the Master attempted to overthrow the Inner Council on Gallifrey with help from students of the Pyrodonian Academy. The rebellion was ruthlessly crushed by Citadel Guards, and there followed a series of bloody reprisals. During this reign of terror, the Doctor lost most of his family. Barely escaping with his life, he and his granddaughter, Susan, fled Gallifrey. They traveled to Earth, arriving there in A.D. 1963. The Master also managed to escape imprisonment on Gallifrey, becoming one of Gallifrey's most dangerous renegade Time Lords.

Enrolling Susan in Coal Hill School in London, the Doctor soon found himself

involved with human Companions, thus beginning his recorded adventures through Earth's history. During one of these, he met The Master, disguised as the Meddling Monk, who was attempting to change Earth history by helping Harold defeat William the Conqueror at the Battle of Hastings. In addition, the Doctor assisted in stopping a Dalek invasion of Earth in A.D. 2164. He foiled a Dalek plot to wipe out Earth's History using a Time Destructor, and prevented the Cybermen of Mondas from draining Earth's energies.

In this first incarnation, the Doctor was a slender, stooped, elderly man. His high cheek bones, thin-lipped mouth, and sometimes severe expression gave him an air of austere superiority. This was enhanced by his long white hair, worn brushed back from a receding hair line, and his conservative Victorian style dress.

Though his outward personality was that of an irascible, sarcastic old man, his dry wit and his true concern for his Companions more than made up for his ill temper. Impatient with the ignorance and failings of humans, he never allowed any-

one to forget that, as a Time Lord, he was vastly superior to them. The first Doctor is considered by many to be the most scientific of the incarnations. Less interested in people than events, he enjoyed collecting facts and statistics. His knowledge of the histories of Earth and Gallifrey was extensive, and he often used this knowledge to draw helpful parallels between the two.

This incarnation of the Doctor spoke of being over six hundred years old and, eventually, his age caught up with him. Having grown fond of this body, he delayed his regeneration until it was almost too late. Fortunately, the TARDIS was able to trigger the regeneration process he was too weak to manage, and the Second Doctor came into being.

### The Doctor, II

In this second incarnation of the Doctor, we see the beginning of an interesting development in the varying personalities of the Doctors — almost a maturing process. The character of the Doctor is growing and learning through his several lives, much as humans grow and learn in the



shorter time span allotted us. As in humans, this sometimes takes the form of a rebellion against our former selves. We notice incarnations of the Doctor utilizing and developing certain facets of his personality, while actively working against others.

Thus, in the second incarnation, we have a Doctor whose personality appears to almost have completely reversed itself. Cheerful, outgoing, even comic, he is much more concerned with people than historical events. In fact, this facet of his personality — almost a backlash against the first incarnation — would eventually be his downfall.

This incarnation of the Doctor is often called a rogue. A middle-aged man with a mop of straight, dark-brown hair worn a la the Beatles, he had an impish twinkle in his eyes that was irresistible. A blue-and-white polka-dot tie that invariably dangled off-center from his open collar shirt added to his rakish appearance. He was the only Doctor to play a musical instrument, finding comfort in blowing tunes on a re-

order, much to the annoyance of his Companions. He adored tinkering with electronics and created the famous sonic screwdriver, but he was a tinkerer only. Despite the fact that the TARDIS was falling apart around him and was completely out of his control, he had not the slightest interest in repairing it.

Although he lived only twenty-five to fifty years, this Doctor did more intervening in time than any other of the incarnations, primarily because of his interest in and desire to help humans. He confronted the Daleks once again, this time meeting the Emperor Dalek. He beat back three invasions launched against Earth by the Cybermen, fought off two attempted invasions by the Ice Warriors, and saved mankind from the dangers imposed by the Great Intelligence and its furry robots, the Yeti.

His major battle, however, came against the War Chief, a renegade Time Lord who broke all the rules and provided an alien race with the means to travel through time. The aliens kidnapped vast numbers

of soldiers from Earths past, planning to use them to create an invincible army bent on galactic conquest.

In order to stop this threat, the Doctor was forced to appeal to Gallifrey to obtain help. The Inner Council intervened, executed the War Chief, then promptly ar-

## Doctor Who Character Data Record

### The Doctor, First Incarnation

	STR	END	DEX	CHA	MNT	ITN
Level	III	IV	IV	III	VI	VI
Score (87)	9	14	13	9	21	21

### Appearance

Race: Gallifreyan  
 Sex: Male  
 Height: Average  
 Build: Slim  
 Looks: Plain  
 Apparent Age: Old Adult  
 Actual Age: up to 600 years

### The Doctor, Second Incarnation

	STR	END	DEX	CHA	MNT	ITN
Level	IV	IV	IV	V	VI	VI
Score (87)	10	10	10	15	21	21

### Appearance

Race: Gallifreyan  
 Sex: Male  
 Height: Short  
 Build: Average  
 Looks: Plain  
 Apparent Age: Middle-aged Adult  
 Actual Age 600 +

### The Doctor, Third Incarnation

	STR	END	DEX	CHA	MNT	ITN
Level	IV	IV	IV	V	VI	VI
Score (87)	10	10	10	15	21	21

### Appearance

Race: Gallifreyan  
 Sex: Male  
 Height: Tall  
 Build: Average  
 Looks: Striking  
 Apparent Age: Middle-aged Adult  
 Actual Age: 625 +

Skill List	Level
Armed Combat, Contact Weapons	
Sword, Medium (DEX)	V
Armed Combat, Ranged Weapons	
Pistol, Stazer (DEX)	III
Crossbow, Light (DEX)	VI
Artistic Expression	
Instrumental Music, Recorder	III
Vocal Music	III
Carousing	
Climbing	
Construction	
Earth Sciences	
Geology	
Hydrology	
Meterology	
Engineering	
Cartography	
Chemical Engineering	
Civil Engineering	
Electrical Engineering	IV
Mechanical Engineering	IV
Metallurgy	
Environmental Suit Operation	IV
Gambling	
Gaming	IV
Leadership	VI
Life Sciences	
Agriculture	
Botany	III
Ecology	
Exobiology	V
Zoology	III
Medical Sciences	
General Medicine	
Gallifreyan	V
Human	V
Psychology, Human	VI
Pathology	
Pharmacology	
Surgery	
Veterinary Medicine	
Military Sciences	
Ordnance Construct/Repair	
Small Unit Tactics	
Trap Discovery	IV
Trap/Ord. Disarmament	IV
Physical Sciences	
Chemistry	III
Computer Science	IV
Mathematics	V
Physics	IV
Public Performance	
Security Procedures	
Concealment	IV
Disguise	III
Lockpicking	V
Stealth	IV
Surveillance	III

rested the Doctor for his meddling in the affairs of men.

Upon his arrest, the Doctor was taken back to Gallifrey where, as punishment for his crimes, he was forced to regenerate and was sent into exile in Earth's twentieth century.

Social Sciences	
Archaeology, Earth	IV
Economics	
Law	
Political Science	III
History	
Earth	V
Gallifrey	V
Galactic	V
Space Sciences	
Astronomy	III
Astrophysics	IV
Navigation	IV
sports	
Boxing	
Cricket	V
Swimming	
Wrestling	
Streetwise	V
Technology	
Astronautics	IV
Communication Systems	
Computer Sciences	IV
Cybernetics	III
Force Field Systems	III
Electronics	IV
TARDIS Systems	V
Transmat Systems	
Temporal Science	VI
Trivia	
Cricket Lore	V
Gallifreyan Myths and	
Legends	VII
Venusian Lore	V
Unarmed Combat	
Brawling	III
Martial Arts	
Venusian Aiki-Do	IV
Grappling	
Vehicle Operation	
Aircraft	III
Ground Vehicles	IV
Spacecraft	V
Temporal Vehicles	V
Water Vehicles	III
Verbal Interaction	
Bluffing	
Fascinate	VI
Haggling	VI
Instruction	
Insulting	
Interrogation	
Lying	
Negotiation/Diplomacy	VII
Oratory	
Scam	
Wilderness Survival	
Arctic	
Cool Temperate	
Warm Temperate	
Tropical	
Desert	

### The Doctor, III

This incarnation of the Doctor managed to successfully combine the best qualities of the two previous incarnations, while softening the worst. He was interested in people but used greater discretion in dealing with them.

A middle-aged man, he was a commanding figure with curly, silver hair, luxuriant sideburns, and a firm, jutting jaw. He was flamboyant in dress and personality, wearing a Victorian-style velvet smoking jacket and a flowing black cape. Warm and outgoing, he was also serenely confident and capable. Though fond of heroic gestures, his affection and regard for his Companions was obvious.

He was an expert engineer, able to completely disassemble the TARDIS and reassemble it again, making it into a precision machine that functioned perfectly – this despite the fact that the Time Lords, as part of his punishment, had taken away a vital part of the TARDIS and also his memory of how to fix it. He rarely used the TARDIS, however, preferring instead to

travel around in either an antique yellow roadster named Bessie or in the Whomobile, a vehicle of his own design.

One of the major factors in the Doctor's personality at this point was his bitterness toward the Time Lords because of the forced regeneration, a bitterness that is passed on to future incarnations. He also became disenchanted with certain humans, particularly after the destruction of the Silurians by UNIT.

Most of this incarnation's one hundred and twenty-five years was based on Earth during its twentieth century. He accepted a position as a science advisor to the United Nations Intelligence Taskforce (UNIT) and, over a period of years, helped defeat a number of enemies. The Master returned as well, making at least eight separate attempts to either kill the Doctor or destroy the Earth. Though the Doctor was able to prevent these, he was never able to catch his wily nemesis.

The Inner Council eventually pardoned the Doctor, but only after he had defeated an attempt to destroy the universe made

## Doctor Who Character Data Record

### The Doctor, Fourth Incarnation

	STR	END	DEX	CHA	MNT	ITN
Level	IV	IV	IV	V	VI	VI
Score (87)	10	10	10	15	21	21

### Appearance

Race: Gallifreyan  
 Sex: Male  
 Height: Tall  
 Build: Stocky  
 Looks: Average  
 Apparent Age: Middle-aged Adult  
 Actual Age: 750 +

### The Doctor, Fifth Incarnation

	STR	END	DEX	CHA	MNT	ITN
Level	IV	III	IV	V	VI	VI
Score (87)	10	9	10	16	21	21

### Appearance

Race: Gallifreyan  
 Sex: Male  
 Height: Average  
 Build: Slim  
 Looks: Attractive  
 Apparent Age: Young Adult  
 Actual Age: 900

### The Doctor, Sixth Incarnation

	STR	END	DEX	CHA	MNT	ITN
Level	IV	IV	IV	IV	VI	VI
Score (87)	10	14	10	11	21	21

### Appearance

Race: Gallifreyan  
 Sex: Male  
 Height: Tall  
 Build: Stocky  
 Looks: Average  
 Apparent Age: Middle-aged Adult  
 Actual Age: 900 +

by Omega, the Time Lord pioneer. Having been trapped in an antimatter universe, Omega used a black hole to begin draining Gallifrey's energy in a desperate effort to return to his own universe. When it became clear to him that he could never escape, Omega decided to drain the entire universe of energy.

Using its last power reserves, the Inner Circle broke its cardinal rule and brought all three of the Doctor's incarnations together to defeat Omega — which the Doctors accomplished by using the second Doctor's recorder. By tricking Omega into touching this positive-matter artifact, they triggered an explosion that turned Omega into a supernova.

Though he had been pardoned, the Doctor could never bring himself to forgive the Inner Council for what it had done to him. He continued to assist humans and was mortally wounded in a rebellion of human slaves against a race of giant spiders on the planet Metebelis 3. Dying, the Doctor returned to Earth where a Time Lord who had been incarnated as a Tibetan monk was able to accelerate his regeneration.

#### **The Doctor, IV**

Witty and irreverent, Bohemian in dress, wild and eccentric in his actions, this incarnation of the Doctor lasted for over one hundred and fifty years. With his mop of wild curls, perpetually pop-eyed look of wonder, and unfortunate tendency to trip over his long, flowing scarf, it seems impossible to take this incarnation seriously. Those who failed to do so regretted it, however.

Although possessed of a warm personality, this incarnation appeared more withdrawn around humans and rarely, if ever, displayed open affection for his Companions. In addition, the resentment of the third incarnation of the Doctor against the Time Lords was manifested even more strongly in the fourth incarnation, who returned to Gallifrey only when forced by circumstances to do so.

The Doctor in this incarnation was an expert in the field of computer science; he also knew more about medicine than his predecessors. Arrogant and fearless, he had boundless energy and amazing self-confidence that was, in some instances, unjustified. Curious and eager to explore, he rarely stayed in one place for any length of time but was always searching for new adventure. His mind worked quickly, sometimes more quickly than his tongue, occasionally making him difficult to understand.

Though the Doctor continued to have an interest in Earth and its inhabitants, and saved them from several villainous types, he became more interested in new worlds and other times. He traveled to the planet Skaro in a futile attempt to stop the wicked Davros from creating the Daleks. Though failing in his assignment, he was able to alter the future enough so that it

seems possible the Daleks could eventually be destroyed.

He returned voluntarily to Gallifrey to prevent the assassination of the Lord President, only to be arrested, tried, and convicted for that very crime. By nominating himself for president, he managed to stall long enough to prove that the Master and Chancellor Goth were the real assassins.

Returning to his travels through time and space, he suddenly and unexpectedly reappeared on Gallifrey, demanding the presidency! Everyone figured he'd tripped over his scarf once too often, but it was eventually revealed that this bizarre act was all part of an extremely serious plan to defeat a combined Vardan-Sontaran invasion of Gallifrey.

There is a gap in the recorded history of the Doctor at this period, during which he and K-9, his mechanical dog, could have been involved in numerous, untold adventures. When the Doctor's history becomes known to us once more, we learn that he was chosen by the White Guardian to assemble the six pieces of the Key of Time. Traveling with K-9 and a Time Lady known as Romana, he managed to successfully complete his assignment. The assembled key was so extremely powerful, however, that anyone of evil intent who got hold of it would be master of the universe. In an attempt to do just this, the Black Guardian sought desperately to get the Key, only to be prevented by the Doctor. Once chaos was averted and balance restored to the universe, the Doctor then had to scatter the pieces of the powerful Key once more so that the Black Guardian did not gain control of it.

Understandably upset by this, the Black Guardian swore revenge on the Doctor. In order to escape this formidable opponent, the Doctor equipped his TARDIS with a randomizer, giving up all directional control of it. After another encounter with the Daleks, the Doctor and Romana found themselves trapped in E-Space. Having been tortured by the Black Guardian, Romana regenerated and chose to remain in E-Space, rather than return to Gallifrey. The Doctor escaped and traveled to the Union of Traken. Here he was again confronted by another of the Master's attempts to gain power and a new regeneration. The Doctor prevented the Master from seizing control of Traken, but could not stop him from obtaining a new body.

When the Master tracked the Doctor to Logopolis, his machinations upset the delicate block transfer computations used by the Logopolitans to prevent the heat death of the entire universe. The Master and the Doctor were forced to work together, replacing the lost Logopolis with the giant computers of the Pharos Project on Earth. Once they succeeded, the Master attempted to turn their victory to his own ends by holding the Pharos Project hostage. The Doctor stopped him, but at the

cost of a fatal fall, resulting in another regeneration.

#### **The Doctor, V**

The fifth incarnation of the Doctor was the briefest and most troubled of the incarnations, probably because his regeneration didn't quite succeed. The destruction of the Zero Room in the TARDIS removed the ability to solidify his personality. Consequently, various parts of the other four personalities manifest themselves occasionally, making this incarnation appear confused and disoriented at times.

This situation is given added irony because the Doctor's body was now young and athletic. He had a pleasant, boyish face and dressed in a white cricket sweater and tan frock coat. He kept a fresh stalk of celery pinned to his lapel, was fond of cricket, and was an expert in the field of cricket trivia. He often showed the abrupt irritation with humans seen in his first form, but this was softened by his sense of fun and ready wit.

Perhaps because of his unformed personality, the Doctor now often appeared reckless, making mistakes that needlessly endangered his Companions. He was generally well-liked by his Companions, however, because of his quiet resolve and dedication to his cause. He was genuinely interested in people and would go out of his way to help them.

Although the third and fourth incarnations of the Doctor would fight an enemy if cornered (the Third Doctor was an expert in Venusian martial arts), the fifth was the first incarnation of the Doctor to use weapons. He needed them. As if he didn't have trouble enough, this incarnation of the Doctor found himself up against almost all the major enemies of the previous incarnations, plus a host of new villains intent on conquering either Earth or the universe.

He had barely regenerated when he escaped a trap set by the Master, who reappeared later with another timenapping plot involving the capture of the passengers and crew of two Concordes. The Doctor managed to rescue the captives but, once more, the Master slipped through his hands.

Omega returned. Still trying to escape his antimatter universe, he plotted to bond the Doctor's material body with his own antimatter form. Although the attempt failed, the Inner Council ordered the Doctor's execution to put an end to this threat. The Doctor was able to prevent this by exposing a traitor loyal to Omega on the Inner Council.

No sooner was the universe safe from Omega than the Black Guardian appeared, determined to destroy the Doctor in retaliation for that small matter concerning the Key. Barely escaping from this encounter with his life, the weary Doctor immediately became entangled with the Master and yet another plot to upset Earth his-



tory. Disposing of this threat, he ran headlong into — of course — the Daleks. It is easy to see why this incarnation only lasted three or four years. He did get to meet three of his previous incarnations in one adventure, however, and some of his old Companions.

When visiting the planet Androzani, the Doctor and his Companion, Peri, both stepped in poison. The Doctor obtained the antidote but, while carrying Peri back to the TARDIS, he dropped half of it, leaving only enough to save Peri. He was forced to regenerate.

### The Doctor, VI

Building upon the previous unstable regeneration, this incarnation of the Doctor, also unstable, decided to atone for his past by becoming a hermit on Titan III, an uninhabited asteroid. Instead, he became involved with a former Time Lord friend who was kidnapping children. After dealing with this and then destroying an evil telepathic gastropod, he and Peri returned to Earth. Here they found the Cybermen once more intent on conquering the planet. Using a captured time-traveling ship, they changed the outcome of their own disastrous invasion of Earth in 1986. With the help of the Cyrons, the Doctor thwarted the Cybermen and destroyed their time-traveling ship.

Since the adventures of this incarnation of the Doctor are just now being reported to us, the information we have been able to attain on him is still incomplete. His present form is certainly the most eccentric of the incarnations, and it is also the most egocentric. No one admires him more than he admires himself. His personality is outlandish. He keeps everyone — Companions and enemies alike — off balance with a constant barrage of bad puns, jokes, and witty remarks. His mode of dress is outlandish as well — red plaid coat with yellow cuffs, yellow-and-black striped pants, green shoes with orange spats, and a blue and white polka-dot neckcloth. Tall and heavy-set, he has curly blonde hair that is constantly a tangled mess.

The Doctor in this incarnation again encountered the Master, who had joined up with a renegade Time Lady, a woman known as the Rani. In another adventure, the Doctor encountered his second incarnation while preventing another Sontaran invasion of Mutter's Spiral — i.e., the Milky Way Galaxy.

New adventures of the Doctor are eagerly awaited and anticipated. Rumors have him returning to Gallifrey, where he is once more brought to trial and where, supposedly, in a move worthy of Perry Mason, the Master takes the stand in the Doctor's defense! There is even the ru-

mored possibility that the Doctor may be forced to stay on Gallifrey as president.

In his nine-hundredth-plus year, given such a wild and obviously flamboyant regeneration, it will be interesting to see the new depths of self this sixth incarnation of the Doctor will explore as he continues (we hope!) to protect the universe from the grave perils that threaten us.

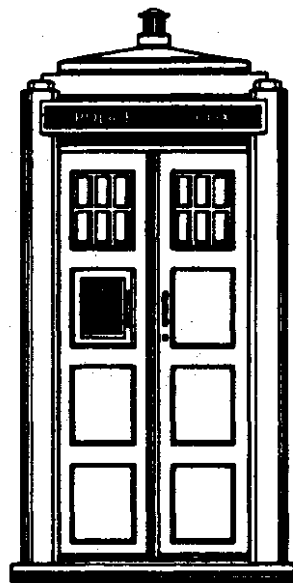

Artwork courtesy of FASA Corp.



**THE ORIGINAL  
BRUCE LEE  
MARTIAL ARTS  
GAME**

**THE LEGEND LIVES**

**COLLECTOR'S EDITION  
BOARD GAME**

**NIGHT OF THE NINJA™**  
**REALITY ROLE-PLAYING GAME®**

**MASTERY  
MANUAL**

**Can you think like a Ninja?  
Do you expect the unexpected?  
Role playing that's real and deadly?**

**IIF GAMES CORPORATION**  
962 James St., Penticton, B.C., Canada V2A 4A7  
(604) 493-5420

NIGHT OF THE NINJA AND REALITY ROLE-PLAYING GAME ARE REGISTERED TRADEMARKS OWNED BY IIF GAMES CORPORATION

# AIM AND BURN

*Flamethrowers*  
in TRAVELLER® gaming

©1986 by William A. Barton

Though restricted in their actual military uses because of their limited range and ammunition, and the inherent hazards of working with flame (especially in situations against high-tech troops), flamethrowers can be effective and terrifying weapons against low- to medium-tech forces. Effective only to medium range, a flamethrower is of greatest use in close-quarters situations — rough and rocky

terrain, caves, pillboxes, forested areas, and urban and interior locations — or against opponents with no ranged-weapon capabilities. Care must be taken when using a flamethrower in highly-flammable environments, such as forests or urban settings. Otherwise, a reckless flamer can quickly become the flamed.

Most flamethrowers are effective only in atmospheres with ratings of 4 (thin,

tainted) through 9 (dense, tainted). In thin atmospheres (4 and 5), they only do half their listed damage because of a lack of sufficient oxygen to fuel the flame. In atmospheres rated 0-3, flamethrowers merely splash opponents with their non-burning fuel mixture. In exotic — or worse — atmospheres (A +), effects may be unpredictable and dangerous, the exact results depending on the atmosphere's composition. Use under such conditions is not recommended.

A word of caution: Flame weapons should not be used in highly pressurized, oxygen-rich, artificial environments, such as aboard starships, due to the possibility of fuel-air explosions or runaway combustion. Roll 7 + on 2D for an explosion doing twice the weapon's normal damage to everyone within range whenever a flamethrower is used in such an environment.

The following are two types of flame weapons commonly found in and around the Third Imperium.

## **The Wickerman flamethrower**

The Wickerman Incendiaries, Ltd., Model G-76f portable flamethrower is a relatively lightweight TL 7 flame weapon. Its components consist of a tank of jellied flammable liquid weighing 9 kg, which is worn on the back, and a short riflelike flame gun attached to the tank by a flexible hose (the tank is considered armored as Cloth +1 and the hose as Jack -2). The flame gun itself is 700 mm in length and weighs 2.5 kg unloaded. The gun carries a cartridge of five rounds that ignite the liquid as it passes through the gun; each cartridge weighs .5 kg. The tank holds enough liquid for five single-shot spurts. One pull of the trigger releases the liquid from the tank, and a second pull immediately afterwards activates an ignition round in the cartridge, igniting and releasing the flaming liquid from the gun. The burning temperature of the ignited fuel is 1,200°C, and the flammable mixture burns for 8 rounds (2 minutes) on nonflammable surfaces, unless extinguished. Flammable surfaces — including living targets — are ignited and burn until consumed or until the flame is extinguished.

One shot of flaming liquid may be released per round, doing 5D damage to the target initially and an additional 2D per round until the flame is extinguished (or the target is dead). The collateral-damage-by-explosives rule from TRAVELLER® Book 4, *Mercenary*, should be used to determine if any secondary targets immediately adjacent to the primary target receive 2D in splash damage on the initial round and 2D burn damage each subsequent round.

Range DMs for the Model G-76f flamethrower are: Close +1, Short +2, and Medium +2. The weapon is useless beyond Medium range. Use at Close range results in an automatic splashback effect on the firer, causing 2D flame damage per round until the flame is extinguished,

unless the user is adequately protected. Use at Short range carries the danger of a splashback as well: roll 9 + for this to occur (-1 DM for a Dexterity of 10 +).

It is possible to adjust the Wickerman flamethrower to fire a wide-angle burst of flame rather than a stream. Doing so reduces initial damage to 3D; it also adds a +2 DM to hit at Close and Short range and a -1 DM to hit at Medium range. The group-hits-from-shotguns rule is used whenever firing the Wickerman on wide-angle flame. Adjusting the flame setting to wide-angle (or back to stream) adds a -3 DM to hit if the weapon is adjusted and fired in the same round. No DM is applied if one round is taken to change the setting without firing.

No armor DMs are applicable to the roll to hit, as the flaming liquid splatters evenly over a target, and the temperatures involved easily burn through most protections. Fully sealed armor gives some protection. It takes two rounds for the flame to burn through regular vacc suits and three rounds for combat environment suits. Wearers of these still take 1D fire damage per round until the armor is burnt through. At that time, if still aflame, they take the initial 5D damage plus 2D each round they remain aflame. Combat armor and battle dress cannot be breached by the flame, but unless the suits were meant for vacuum or hostile-environment use, the wearer takes 1D heat damage per round until the flame is extinguished. Each additional application of flame reduces the time to burn through armor by one round. The exact extent of damage to armor and external systems (face plates, lights, etc.) due to partial burn-through must be determined by the referee.

Required Dexterity for the Wickerman flamethrower is 6, with a -1 DM if Dexterity is 5 or less. Advantageous Dexterity is 11, for a +1 DM. (It should be noted that exact precision is not a requirement for using the flamethrower, as a near miss on a target that hits an adjacent target may still splatter the original target with burning liquid.) It takes one round to replace an ignition cartridge, with the firer considered to be evading. It takes four rounds to replace a fuel tank, five if evading (two and three respectively if assisted by another person).

A complete Wickerman Model G-76f portable flamethrower unit costs Cr 1000, including one full tank and one ignition cartridge. Replacement tanks of the jellied liquid cost Cr 250, Cr 100 for a refill of the liquid only. Ignition cartridges cost Cr 50 each. Rounds for the cartridge may not be purchased separately. Flamethrowers are considered military weapons and are generally prohibited at law level 3, though certain liberal governments may allow licensed use by civilians in nonpopulated areas at law level 4. The weapons are more popular with militia and police units than regular military forces and can be

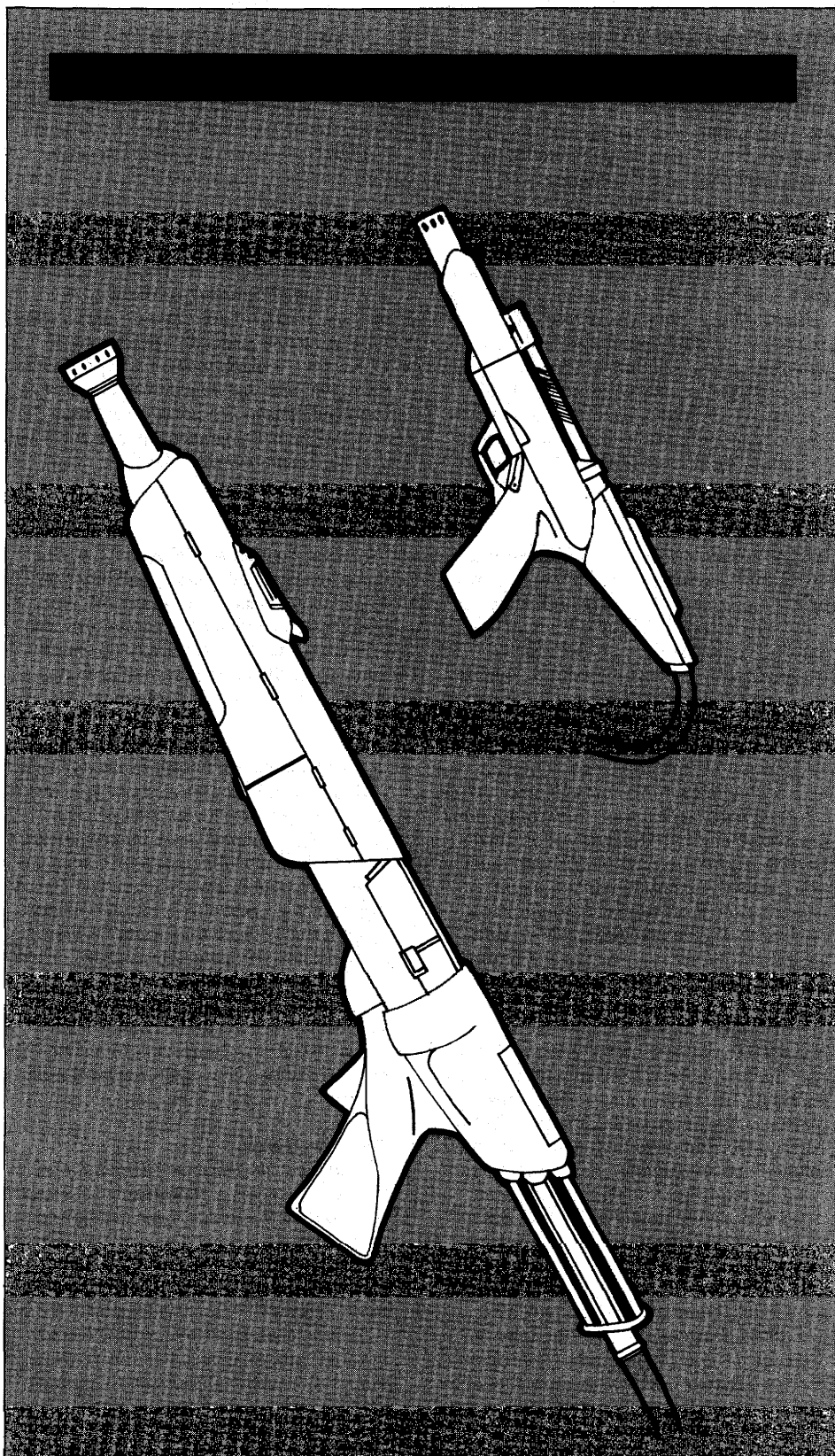

quite effective for riot control if used with extreme caution.

The Wickerman Model G78f flamethrower is of medium-to-high reliability and is of medium availability throughout the Imperium and surrounding areas. Should an adventurer seek to purchase one, a roll of 8+ enables him to find one for purchase, provided the law level of the world on which he is searching is low

enough for the weapon to be available (+1 DM per level of Streetwise if searching through semilegal channels, +1 DM per level of Administration if attempting to purchase through government surplus supplies, etc.). If attempting to locate one on the black market on a world where the weapons are prohibited, a roll of 12+ (with only Streetwise as a +DM) is required.



## Winterhawk Hand Flamer

The TL 10 F73 Hand Flamer, available from the Winterhawk Arms Co., in the Antedeluvia Subsector of the Far Frontiers, and exported throughout the Imperium, is the ultimate in portable flame weapons before the development of plasma weaponry. The F73 Hand Flamer consists of a 300-mm long pistol-like flame gun, similar in appearance to a long flare gun, attached by a flexible hose to a backpack fuel tank (tank armored as Cloth -2 or Battle +2, whichever is best, and hose as Mesh -1). The entire unit weighs 7.5 kg when the tank is full (5.5 kg for the tank, 2 kg for the gun and hose). A full tank allows 20 shots, each pull of the trigger expending one shot. The fuel for the flamer is laser-ignited in the flame gun, and is a special mixture of solid and liquid flammable compounds and superheated, near-plasma gases that burn hotter (2,500°C) and longer (10 combat rounds on a nonflammable surface) than those used in lower tech-level flamethrowers.

A hit by a Hand Flamer does only 4D damage on the initial hit, but burns for 3D damage each round until extinguished (or the target is dead). Due to a self-contained oxygen component in the fuel of the F73, its flame is very difficult to extinguish; roll 11 + for success whenever attempting to do so. The flame of the Winterhawk Arms Hand Flamer can even burn through combat armor and battle dress within three rounds, and it burns through vacc suits and combat environmental suits one round faster than the Wickerman. Heat damage to the armor wearer is double that of the Wickerman while the flame is burning through. Thanks to its oxygen component, a Winterhawk Hand Flamer is as effective in thin atmospheres as in standard-to-dense atmospheres, and still does half damage in very thin atmospheres (2 and 3). In vacuum and trace atmospheres, it also does half damage, but the flame burns out after two rounds unless followed by subsequent shots.

Range modifiers for the Winterhawk Arms F73 Hand Flamer are: Close +3, Short +4, and Medium +1. There is no danger of splashback at Short range and only a chance at Close range (the same as for a Wickerman at Short range). The group-hits-from-explosives rule may be used for a Hand Flamer only if set on wide-angle beam, which uses up fuel at a rate of two shots per use, but adds a +1 DM to hit at all ranges. Changing the setting on a Hand Flamer requires only a flick of the thumb and only a -1 DM to hit if the flamer is fired on the same round the setting is switched.

Required Dexterity for a Winterhawk Hand Flamer is 8, with a -1 DM for a Dexterity of 7 or less. Advantageous Dexterity is 11 for a +1 DM. It takes only half the time to change an empty fuel tank for the Winterhawk as for the Wickerman under all circumstances.

A complete Winterhawk Arms F73 Hand Flamer costs Cr 2500. Replacement tanks cost Cr 1000 each, and a refill of the tank costs Cr 500. Hand Flamers are outlawed at law level 2, except for use by official military forces (though they are often found in the possession of TL 11-mercenary units without access to plasma weaponry). The Winterhawk F73 is considered to be of high reliability but is of low-to-medium availability. On planets where it may be legally owned, a roll of 11 + is necessary to find any for sale (same DMs for Streetwise and Administration); if looking for a black-market weapon where Hand Flamers are illegal, a roll of 14 + is required. There are never more than 1D +1 available for sale at any one time, half that for black-market sales.

## Other flamethrowers

A number of other models of flamethrowers may be available at TL 6, but these are generally much bulkier than TL 7 models such as the Wickerman. Normally, such TL 6 varieties consist of two fuel tanks and an electrically operated flame gun, the entire unit weighing up to 20 kg. The number of shots may vary from 8 to 10, and the weapon is only safe to use at medium range, with DMs similar to the Wickerman. Required Dexterity is 7, with a -2 DM for Dexterity of 6 or less. Advantageous Dexterity is as per the Wickerman. Damage may be greater, up to SD per shot, and the group-hits-from-explosives rule is always used. Danger to the user is greater if hit, too (see below), though the tank, thanks to its heavier construction, is protected as Cloth. Prices on TL 6 flamethrowers are half again as much as for the Wickerman, but they are generally more available than Wickermans. Roll 6 + to locate on any world they may legally be possessed (law level 2 or lower).

## Referee notes

Whenever a character using a flamethrower receives a penetrating hit from behind (use the tank armor rating to determine this), roll 2D. On a roll of 10 + for a Wickerman, 9 + for any TL 6 flamethrower, and 11 + for a Winterhawk Arms Hand Flamer (9 + for the Flamer if the hit is from a laser, explosive, or HE round), the fuel tank explodes. For the Wickerman, this causes 8D damage to the user and anyone within 3 meters. It also coats the user and anyone within 3 meters with the flaming liquid, and anyone within 5 meters must roll their Dexterity or less on 2D to avoid being coated as well. Everyone within 5 meters must also roll their Strength or less on 2D to avoid being knocked down by the concussion from the explosion. Explosive damage is doubled for TL 6 flamethrowers. An exploding Hand Flamer tank does 10D damage to the user and anyone within 3 meters, and 5D damage to anyone within 5 meters.

On a roll of 6-9 with a penetrating hit against a Wickerman tank, the tank is holed and the liquid ignited, coating the character with the flaming liquid. On a roll of 5-, the character is coated with nonignited liquid, but must avoid flame, sparks, etc., until the liquid is removed. If the weapon that hits and penetrates the tank is a laser or high-energy weapon, or an explosive round, the tank always explodes. Anyone attempting to help extinguish flame on burning characters at Close range must roll Dexterity or less on 2D each round to avoid contacting the flaming liquid themselves. Rolls for TL 6 flamethrowers to coat the user with flaming and nonflaming liquid are as per the Wickerman minus one. Hand Flamers do not leak if simply penetrated, due to the self-sealing nature of their tanks.

If a flamethrower is used against sentient opponents, an immediate morale check is required. If the opponents stand, morale is only checked again if anyone is hit by the flamethrower, or as outlined in TRAVELLER Book 1, *Characters and Combat*, page 33. Whenever a flame weapon is used against animals (except those that are completely mindless), the referee should immediately roll the animal's score to flee, with a +3 DM applied to the roll or a +5 DM if the animal is actually hit by the flame. Animals from extremely hot, dry, or volcanic environments may not fear flame as much as others; DMs for such beasts are up to the referee.

Apply a -3 DM to hit for the first 1D times a character attempts to use a flamethrower (but not a Hand Flamer), to reflect the learning of correct techniques for aiming and firing such a weapon, unless the character would be familiar with flame weapons from past experience in the service. (Generally, this only applies to characters who have served in the Army of TL 5-7 worlds; a roll of Education or less on 2d may be used to determine familiarity.)

## Asbestos spray

Asbestos spray comes in aerosol cans containing enough spray to coat four complete suits of armor or clothing per can. The spray makes the wearer immune to the burning effects of flame (though 1D damage per round may result from breathing superheated air, unless protective gear is worn). Characters coated with flaming material also take 1D per round heat damage unless protected by refrigerated suits, etc. To derive full benefit from the spray, the character must be completely covered with boots, gloves, and complete head protection; otherwise, the normal damage is only reduced by half. Each coating of spray lasts one week before requiring renewal (less if the character is involved in vigorous activity) or stands up to three flame attacks, whichever is less. Cans of asbestos spray are available at TL 7 + and cost Cr 50 each. Each can weighs .25 kg when full. †



# Are you missing

## a DRAGON® magazine

### in your lair?

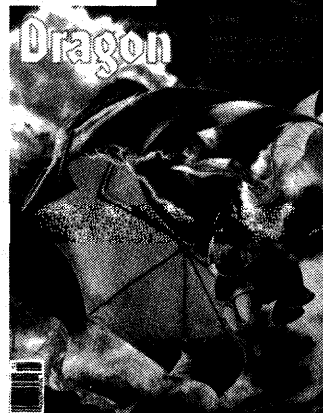

Well, a limited number of back issues of DRAGON® Magazine is available through The Mail Order Hobby Shop. Or, if you've been searching in vain for that special article that appeared in the now out-of-print issues of DRAGON Magazine, our Best Of DRAGON® volumes might fill your need.

Just take a look at the list below, then check the lines of those issues you'd like to order. If you want more than one copy of a specific issue, write the number of copies on that issue's line.

These offerings are priced at \$3.00 each (except for all issues after #105, which cost \$3.50, and the Best of DRAGON® anthologies); payment in U.S. funds **only**. Be sure to add shipping and handling charges. Then, complete and mail the order form below.

(Please PRINT all information plainly)

Name \_\_\_\_\_

Address\* \_\_\_\_\_

City \_\_\_\_\_

State/Prov. \_\_\_\_\_ Zip \_\_\_\_\_

County \_\_\_\_\_

Date \_\_\_\_\_

\*Please use street address, not a P.O. Box number.

Check one to indicate your choice of payment

- Check enclosed                       MasterCard\*
- Money order enclosed               VISA\*

\* Minimum credit card order: \$15.00 No exceptions, please.

Name to which credit card is issued \_\_\_\_\_

Credit Card No. \_\_\_\_\_

Expiration Date \_\_\_\_\_

Signature of the person to whom credit card is issued \_\_\_\_\_

Allow four to six weeks for delivery.

DRAGON is a registered trademark owned by TSR Inc. **MAIL TO:** The Mail Order Hobby Shop, P.O. Box 756, Lake Geneva, WI 53147

©1986 TSR, Inc. All Rights Reserved.

**Make checks or money orders payable to:** The Mail Order Hobby Shop

#### ISSUES AVAILABLE

DR115

- |          |           |           |
|----------|-----------|-----------|
| ___ # 70 | ___ # 88  | ___ # 102 |
| ___ # 73 | ___ # 89  | ___ # 103 |
| ___ # 74 | ___ # 90  | ___ # 104 |
| ___ # 76 | ___ # 91  | ___ # 105 |
| ___ # 77 | ___ # 92  | ___ # 106 |
| ___ # 79 | ___ # 93  | ___ # 107 |
| ___ # 81 | ___ # 94  | ___ # 108 |
| ___ # 82 | ___ # 95  | ___ # 109 |
| ___ # 83 | ___ # 96  | ___ # 110 |
| ___ # 84 | ___ # 97  | ___ # 111 |
| ___ # 85 | ___ # 98  | ___ # 112 |
| ___ # 86 | ___ # 99  | ___ # 113 |
| ___ # 87 | ___ # 100 | ___ # 114 |
|          | ___ # 101 | ___ # 115 |

#### Best of DRAGON® anthologies

- \_\_\_ Volume I (\$3.95)
- \_\_\_ Volume II (\$3.95)
- \_\_\_ Volume III (\$3.95)
- \_\_\_ Volume IV (\$4.50)
- \_\_\_ Volume V (\$4.50)

Subtotal of all magazine costs	\$
Illinois & Wisconsin Residents, add 5% sales tax	\$
Shipping & handling, regardless of number of magazines	\$ 4.50
<b>TOTAL AMOUNT DUE</b>	\$

# GAMERS' GUIDE

## CAST YOUR OWN FANTASY FIGURES



10 New Molds  
Fantasy Chess Set - Special Figures

### SPECIAL

Fantasy Starter Set plus catalog  
only \$11.30 post paid.  
(A Regular \$19.35 Value)

Or send \$1.00 for catalog with color insert

**THE DUNKEN CO.**  
P.O. Box 95D  
Calvert, TX 77837  
(409) 364-2020

Casting your own Figures  
is almost as much fun  
as playing the game.

## Game Master's Guide™

dungeon master utilities

Creatively design and run FRP games FAST with GAME MASTER'S GUIDE™. Easy to use. Copyable. Listable. Modifiable!

**GMI** — All Dice Rolls, Critical Hits, Fumbles, Combat Tables, Items, Random Functions, Treasures, 14 Shops, storage for 200+ Monsters, 51 Treasures, 51 Characters or NPC's, Dieties Hall and More!

**GMI** — 7 Towns, each with background and multiple functions! 50 Tricks, that are sure to keep your players on their toes! Grand Tournament Grounds, 115 opponents that are always ready for a challenge! Shark Races! Troop generation (1-20k), Hall of Justice and More!

**GMI** — Create NEW, WHOLE Characters and Monsters, each with NAME, all stats, items, attitude, etc. Warring Armies that battle on Screen! 50 Bonus Tricks for GMI and More!

**RAI/MORTH'S HOLLOW™** — Our first computer scenario! Includes: Maps, Keyboard overlay, Detailed Manual, RAI/Morth for the Apple\*, \$29.95. GMI for the 512K Macintosh\* \$28.00. GMI:11111 for the Apple\*, C-64\* \$24.95 each. 2 for \$42.50 all 3 for \$60.00. Add \$1.50 S/H to US and APD, (CA, MO, NC, VISA) US. WALTER COMPUTER SERVICES — 32 Greenwood Avenue, Lancaster, PA 17603 or call (717) 299-4646

## ALL NEW!



Official, Leading-Edge  
**TRAVELLER**  
Rule Supplements and  
Adventures

...from  
Digest Group Publications

"Fully approved by Marc Miller (designer of TRAVELLER)  
as official, leading-edge TRAVELLER material."

101 Robots \$7 — Grand Survey \$7  
Travellers' Digest 1 yr. sub. \$14  
**At your dealer today!**

Or direct from Digest Group: Dept L5: 8979 Mandan Ct.:  
Boise, ID 83709. Phone: (208) 362-3094. MC and Visa OK.  
Include \$1 P&H per order.

**NEW** AN EXCITING GAME OF  
STRATEGY AND SKILL FOR  
THE WHOLE FAMILY

## MAREMBA

FAST PACED ACTION  
DOWN TO THE LAST

TURN

\$19.95 US / \$23.95 CDN.  
POSTAGE INCLUDED

FOR OTHER FINE  
COLLECTOR'S GAMES  
ROLL PLAYING GAMES  
WARGAMES  
AND DRAGON® MAGAZINE  
BACK ISSUES  
SEND \$2.00 FOR CATALOGUE TO



TO  
**DISCOUNT WARGAMES**  
P.O. BOX 818, STATION C, TORONTO, ONTARIO  
M5U 3P8

DRAGON is a registered trademark owned by TSR Inc.

## QUALITY DICE

Western Bones

467 Saratoga Ave. Ste 263  
San Jose, CA 95129

Presents:

CHALLENGES DICE SETS  
9dice; 4d6, 1d4-20

GEM SETS.....\$2.95

Clear, Red, Blue

SOLID SETS.....\$2.25

White, Red, Blue, Black

ADD - \$.50 Mail Order

## SEARCHING FOR ADVENTURE GAMES AND SUPPLIES?



Forget the monsters — get the

# WARGAMES WEST

Free Catalog

Write to:

**WARGAMES WEST**  
3422 Central Ave. SE  
Albuquerque, NM 87106

## SPIRAL ARM

Spiral Arm is our latest play-by-mail game of strategic galactic conquest. Designed by The Australian Wizard, Spiral Arm features a map of over 650 stars, up to 50 players per game, economic production, 7 ship classes, 8 racial types, 4 modes of space movement, space and planetary combat, colonization, and technological development. You can name your Empire and new stars. The customized turnsheet is in a convenient "fill-in-the-blank format" for easy use in submitting orders.

Costs: Rules \$2.50

Turn fees: \$4.50 per turn

Game Entry: \$15.00

(Set-up and 3 turns)



## FEUDAL LORDS

Feudal Lords is our original, and most popular, play-by-mail game of medieval power politics. Fifteen players struggle to become King of England after the death of King Arthur by means of medieval economic development, military conquest, and diplomatic intrigue. Feudal Lords features agriculture, trade, knights, mercenaries, ships, bribes, spies, and much more.

Costs: Rules \$2.50

Turn fees: \$3.00 per turn

Game Entry: \$10.00

(Rules, set-up, and 3 turns)

For further information on our games,  
write to:

**GRAAF SIMULATIONS**  
27530 Harper  
St. Clair Shores, MI  
48081-1924



## YOUR CHARACTER



CUSTOM AIRBRUSHED BY  
OUR PROFESSIONAL ARTIST  
IN FULL COLOR ON  
QUALITY SPORTS T'S OR  
SWEATSHIRTS.

EACH IS CUSTOMIZED  
AND IS PERMANENTLY  
DESIGNED FROM YOUR  
SPECIFIC CHARACTER  
SHEET, SKETCH, OR  
DESCRIPTION.

PRICES STARTING AT:  
SPORTS T'S ..... \$19.95\*  
SWEATSHIRTS ..... \$29.95\*  
(EXTRA CHARACTER ADD \$10.00 EACH)  
TAPESTRY 21" x 4"  
STARTING AT ... \$49.95\*  
\*(ADD \$2.00 SHIPPING & HANDLING)

**Bring Your Character  
to Life in Full Color!**

TO ORDER SEND TO DENNY PALMER  
P.O. BOX 302  
BREMERTON, WA 98310

## The Wizard's Corner

Saskatchewan's FRP Game Centre  
Fantasy, Sci-Fi, & Wargames

801C Broadway Avenue  
Saskatoon, Saskatchewan  
Canada S7N 1B5

NOW with a second location:  
2124B Broad Street  
Regina, Saskatchewan

Drop in to either location, or send \$2  
for catalog to Saskatoon address



**FANTASTIC FANTASY  
GAMES & TOYS**

**GOOD PRICES  
MONTHLY SPECIALS**

**ALL MAJOR GAME SYSTEMS  
& ACCESSORIES**

**MINIATURES**

**COMPUTER GAMES**

**VISA & MASTERCARD ACCEPTED**

**FOR FREE CATALOGUE  
WRITE TO**

**FANTASTIC FANTASY  
PO BOX 1143  
EVERETT, WA 98206-1143**

**Your own Full Figure  
CHARACTER**

Rendered by Professional  
Illustrators • 8½x11

ROLE PLAYING: SUPER HERO  
SCIENCE FICTION, FANTASY

**FREE** character description sheet.  
(ENCLOSE 2 POSTAGE STAMPS)

**ANVIL™  
ENTERPRISES**  
P.O. Box 4028  
Indianapolis, FL  
32903



**FULL SCALE DUNGEON**  
(25mm scale drawings)

**"Halls of the Mountain King"**

The "Halls of the Mountain King" contains 59, 22"x34" beautifully illustrated maps drawn to 25mm character scale representing a dwarven city under a mountain. The dungeon is divided into 5 "levels" and each level is accompanied by a booklet of room descriptions. There are over 200 separate rooms viewed from above in the entire dungeon. This dungeon is not "stocked" with monsters or treasure but is a fantasy game playing aid showing rooms with a wealth of detail and complete room descriptions.

Level A	— 1 booklet - 11 maps —	\$16.00
Level B	— 1 booklet - 11 maps —	\$16.00
Level C	— 1 booklet - 14 maps —	\$16.00
Level D	— 1 booklet - 12 maps —	\$16.00
Level E	— 1 booklet - 11 maps —	\$16.00
Full Set	— 5 booklets, 59 maps —	\$75.00

Shipping costs included in price.  
Send check or money order to:  
Pl. CO.  
Box 5206, Aloha, OR 97006

1310 College Ave., Suite 1151, Boulder, Colorado 80302. (Add \$1 shipping)

**DRAGON TREE SPELL BOOK \$7.50** (224 spells, 4 magic systems)

**HANDBOOK OF TRAPS & TRICKS \$9.95** (104 non-killer traps)

**DESERT FLOTS \$7.50** (Green mystery campaign)

**THE LAST GRIMOIRE \$9.95** (The last grimoire)

**THE DARK DREAMS \$7.50** (The dark dreams)

**MONSTER FILE # 1 \$5.00** (48 new illustrated monsters)

**MAGICKN MENTAL # 1 \$5.00** (48 new illustrated monsters)

**THE DARK DREAMS**  
The Arduin Grimoire Vol. II

**THE LAST GRIMOIRE**  
The Arduin Grimoire Vol. III

By: *Ronald A. Hargrave*

\$9.95 each  
from **THE DRAGON TREE**

© 1987 Dragon Tree Enterprises. All rights reserved. No part of this publication may be reproduced, stored in a retrieval system, or transmitted, in any form or by any means, electronic, mechanical, photocopying, recording, or by any information storage and retrieval system, without the prior written permission of Dragon Tree Enterprises.

*Soie de Japan*

A jungle-book fantasy on a luscious silk scarf. Thirty-six different animals portrayed in twenty-eight different water colour tints in a magnificent setting on a 10" x 60" silk scarf. Absolutely beautiful!! Makes an excellent gift!! 100% satisfaction guaranteed. Please allow 2 weeks for delivery (USA). We accept money orders, postal checks, personal checks, and travelers checks. No C.O.D. or credit card orders. Please do not mail cash. \$24.00 ppd. (silk menagerie) Send your order to:

T.S.C.  
45 Broad St.  
P.O. Box 6857  
Boston, MA 02102

**NEW FROM** *Dealer inquiries invited*  
**GAMESCIENCE**  
**ZOCCHIEDRON™**  
**100-SIDED DICE**

Now after more than 3 years perfecting the design, Gamescience offers the true D100 for gamers, so unique it's patented! Though no larger than a ping pong ball, it has 100 identical faces equidistantly spaced on its spherical surface. And the easily-read digits are inside the die where they cannot wear off. The DM Guide provides more than 100 uses for this die, which is ideal for use with all role playing and miniatures games. Available in white, red, orange, green, purple or gray, only \$5 plus \$2.50 shipping. Send \$13.50 for complete High Impact® polyhedra set and matching color Zocchihedron(tm). Order from:

**ZOCCHI DISTRIBUTORS, Dept. D**  
1512 - 30th Avenue - Gulfport, MS 39501



**\$\$\$ Off**  
**YOUR GAMING SUPPLIES**

**TSR • Avalon Hill • GDW  
Ral Partha • Grenadier  
Games Workshop • FGU  
Hero... and More!**

**Give a Gift Certificate**  
— The Perfect Gift

**For FREE 52-Page  
Catalog or Order —**

Call or Write  
**MOUNTAIN MAGE**  
P.O. Box 440298 • Aurora, CO 80044  
303/680-0400

**VISA • MASTERCARD**

**CORESHIRTS™ ARE HERE!**  
**For You or Your Favorite D.M.**

Highest Quality 100% Cotton Long-sleeved Silver-Gray T-Shirts with 2 Color Silk-screened Image. Sizes: S, M, Lg & X-Lg

**Only \$19.95**

Plus \$2.50 Shipping & Handling for each shirt ordered. Send your name, address, phone and shirt order along with check or Money Order to:

**COREGAMES™**  
P.O. Box 1213  
Santa Cruz, CA 95062

Please indicate sizes and quantities. Allow 4 to 6 weeks for delivery. California residents add 6 1/2% state sales tax.

EVER TURN YOUR BACK ON A DRAGON

Artwork on Front

Printed Both Sides

Artwork on Back



**IMAGINATIVE  
MAIL ORDER**

**★ GREAT PRICES ★**

RAL PARTHA    JAMES BOND  
GRENADIER    CAR WARS  
TSR            MORE!

**FAST SERVICE!**

Send \$1 for Catalog  
(Refundable with first order!)

Box 100  
Hawleyville, CT. 06440

**NEW**

**MULTI-LEVEL  
CONCEPT**

MODULES FOR ANY  
LEVEL PLAYER OR PARTY

Discover the secret behind  
"EVILCOLOREDGREEN" \$5.00

Find ancient ruins in  
"THE TEMPLE OF CHEELAKA" \$5.00

Send for Free Catalog

**CALYPSO  
SYSTEMS  
INC**

P.O. BOX 843  
BRANFORD, CT 06405

For use with role playing systems

## Index to Advertisers

Adventure Systems	45
Bard Games	43
Britton Designs	42
Chaosium Inc.	5
DBE Inc.	34
DRAGON® Magazine	93
DUNGEON™ Adventures	45, 57
Fantasy Games Unlimited	35, 56
FASA Corporation	23
Game Designers' Workshop	16-17
Game Systems Inc.	44
Games Workshop	77, inside front cover, center insert
Holubek	79
Iron Crown Enterprises, Inc.	1, back cover
Ishi Press	50
Leading Edges Games	51
Mayfair Games	inside back cover
Milton Bradley	7
ORCCON	96
Palladium Books	43, 65, 73
Panther Games	74
R. Talsorian	70, 75
Skyrealms Publishing	82
Steve Jackson Games	83
Supremacy Games	55
TSR, Inc.	8, 25, 37, 71
TU-E Games	89
West End Games	31
Winter Fantasy	55

# CONVENTION CALENDAR

## S.A.G.E. III, Dec. 27

The "Simulation Adventure Game Expo" will be held at the Airport Holiday Inn in Visalia, CA, from 9 a.m. to midnight. This one-day event features non-stop role-playing, board, miniatures, and computer gaming, and offers a dealer's room and a used game auction.

Memberships at \$5 at the door. For more information, send a SASE to: S.A.G.E., c/o Galactic Productions, P.O. Box 4517, Visalia CA 93278-4517.

## EVECON 4, Jan. 2-4, 1987

This fourth annual national convention, which is sponsored by FanTek, will be held at the Stouffers Concourse Hotel in Crystal City, VA. Featured events include all types of games, Cinemascope movies, music, an art show and sale, a Merchants' Bazaar, and a host of other activities. Pre-registration is \$15 until Dec. 10, and \$20 the day of the event. For further information, send a SASE to: EveCon 4, c/o Bruce Evry, Box 128, Aberdeen MD 21001, or call (301) 422-1235.

## UNIVERSE 87, Jan. 2-4

This convention will be held at the Airport Hilton Hotel in Los Angeles, CA. Over 180 game tournaments are featured in a variety of role-playing games, wargames, and family games. Other activities include a full program of science-fiction and fantasy events, plus exhibitions, seminars, and movies. Admission is \$16.50 until Dec. 13, and \$20 thereafter. For more details, contact: UNIVERSE 87, Dept. D, P.O. Box 2577, Anaheim CA 92804. For general information on Universe 87, call (213) 920-8705.

## HAVOC III, Jan. 17-18

Battlegroup Boston will sponsor this third annual convention, which is being held at the Central Middle School, 55 School St., in Waltham, MA. Planned events include SFB, Space Marines, Modern Micro Armor, WWI Naval, British Colonial, and a variety of other simulations. To receive information, send name and address to: HAVOC III, P.O. Box 70, Alston MA 02134, or call (617) 354-6229 (days) or (617) 893-3677.

## PANDEMONIUM IV, Jan. 17

This gaming convention will be located in the Hub Cafeteria, Ryerson Polytechnical Institute, 350 Victoria Street, Toronto, Canada. Events include fantasy role-playing tournaments, board games, miniature contests, auctions, dealers, and more. Registration is \$7 before the convention and \$8 at the door. For more information, write to: The General Staff, P.O. Box 425, Station A, Downsview, Ontario, CANADA, M3M 3A8.

## GRIFO CON, Jan. 23-25

Sponsored by "I Giochi dei Grand" game shop in Verona, this convention will be held at the Hotel Mediterraneo in Marina di Grosseto, Grosseto, Italy. Featured events include a 3-round AD&D® tournament, BATTLESYSTEM™ and Warhammer game miniatures battles, and

other role-playing and fantasy board games. For more details, contact: Robert Di Meglio, Via Mamelì 50, C.A.P. 58100, Grosseto, ITALY.

## CALCON II, Jan. 30-Feb. 1

This gaming convention will be held at the University of Calgary in Alberta, Canada. W. Backhaus (co-creator of *Chivalry and Sorcery*) is the Guest of Honor. Special events include an AD&D tournament with a guaranteed first prize of 50% of the tournament fee (tournament entry fees are \$5 per person). Other events include a variety of role-playing, board, and miniatures games. Registration is \$3 until Dec. 1, 1986, \$5 until January 15, 1987, and \$6 at the door. For further information, write to: Calcon II, P.O. Box 762K, 2500 University Drive N.W., Calgary, Alberta, Canada T2N 1N4.

## WARCON 87, Feb. 6-8

WARCON 87 will be held at the Texas A&M University. Events include role-playing camps, boardgames, a miniatures contest, guest speakers, and a schedule of movies. Interested persons are invited to contact: WARCON 87, c/o MSC NOVA, Texas A&M University, College Station TX 77841, or call (409) 845-1515.

## DUNDRACON XI, Feb. 13-16

The oldest gaming convention on the West coast, DunDraCon XI will be held at the Oakland Airport Hyatt Hotel. Events will include open gaming, con-sponsored games, a dealers' room, seminars, SCA demonstrations, a flea market, and a figure painting contest. Memberships are \$15 through Feb. 1, \$20 at the door, and \$10 for one-day registrations. For more details, write: DunDraCon XI, 386 Alcatraz Ave., Oakland CA 94618.

## FOLIE-CON '87, Feb. 27-March 1

This bilingual gaming convention will be held at the Ramada Inn in Montreal, Quebec. Featured events will include AD&D tournaments, a variety of role-playing games, micro-armor and miniature events, 24 hour videos, wargames, and BASTON. There will be lots of prizes awarded to tournament winners. Registration fees for the weekend are \$10. For more details, contact: Folie-Con '87, 4651 Berri, Montreal, Quebec, Canada H2J 2R6, or call (514) 526-1174.

## KING KON 7, March 13-15

Celebrating its seventh year of success, King Kon 7 will be held this year at the Embassy Suites at 7290 Commerce Center Drive in Colorado Springs, Colo. Robert Vardeman will be the Guest of Honor, along with Sontow Sucharitkel as Toastmaster and Don C. Thompson as Fan Guest of Honor. This science fiction convention will feature author's readings, panel discussions, lectures, an art show and auction, movies, a 22 hour con suite, a masquerade contest, and much more. Memberships are \$15 until January 1, 1987, \$17 until Feb. 1st, and \$20 at the door. For more details, send a SASE to: King Kon 7, P.O. Box 16597, Colorado Springs CO 80935, or call (303) 520-1241.

**STRATEGICON**, the people who brought you L.A. Origins '86 presents

## ORCCON 10

The Western Regional Game Convention and Exposition

ORCCON 10 is a complete Strategy Game Convention featuring three full days of tournaments, demonstrations, exhibitors, prizes and other gaming activities.

All of your favorite role-playing games are featured as tournaments, including: ADVANCED D&D® game, Traveller, Champions, Twilight 2000, James Bond, Star Trek, Paranoia, plus much more including boardgames and the latest in computer gaming.

ORCCON 10 will be held at the Los Angeles Airport Hyatt Hotel, February 13th - 16th, President's Day Weekend, 1987. Pre-registration is only \$16.00 if postmarked by February 1st, 1987. Note that there are no separate charges for individual events (a STRATEGICON tradition).

To pre-register or for complete information, write to:

Diverse Talents, Inc.  
Dept. ORCCON 10  
P.O. Box 8399

Long Beach, CA 90808

or call: (213) 420-3675

**YOUR BEST GAMING MOVE IS IN SOUTHERN CALIFORNIA!**

ADVANCED D&D is a registered trademark owned by TSR Inc.

# SNARF QUEST

#41

BY ELMORE

LATER.

SOMEONE SHOULD CHECK ON SNARF AND EFFIM, THEY'VE BEEN DOWN TO THE RIVER A LONG TIME.

I'LL GO CHECK ON THEM...

KEEP AN EYE ON OUR LOOT... THE REST OF YOU SHOULD TALK TO THE CROWD AND CONVINCE THEM TO VOTE FOR SNARF.

WHAT IN THE WORLD IS THIS STUPID ROBOT DOING? MAINTENANCE 'BOTS MUST NOT BE VERY BRIGHT.

... AND MUD ALL OVER YOUR VISOR!

WOW, I THOUGHT I HAD BEEN KNOCKED INTO OUTER SPACE... EVERYTHING WAS BLACK AND I FELT WEIGHTLESS.

WHAT HAPPENED? AND WHERE IS SNARF?

I WAS TALKIN' TO SNEEVE WHEN SOMEONE WARPED ME FROM BEHIND...

YOU NEED YOUR SENSORS CLEANED.

LAST I SAW SNARF, HE WAS OVER THERE TALKING TO THAT MONSTER.

STHAND BACK BOYSTH! I'LL PROTECT YOU!

AVEEARE?

I KNOW YOU! WILLIE, THE DRAGON!

I GOTTA DO IT DISTH TIME!!

UUOOOAAAARA

DAT MAGIC ROCK STHNEEVE GAVE ME FINALLY WORKED!

MAN, IT'S GETTIN' TOO HOT IN HERE, GAAA, I'M ON FIRE! WILLIE! DAT @\*#M!

DAT BOYSTH, IS A STHACK FULL OF STHNAKESTH!

SSSSSS

SPLASH!!

I THINK WE ISTH STHAFE NOW!

STHNARF?

SNARF?

GGRRRR

A FEW MINUTES LATER, SNARF GATHERED ALL THE VILLAGERS TOGETHER AND TRIED TO EXPLAIN HOW NEWFERT COULD CAPTURE A DRAGON.



YA SEE, DAT DRAGON IS A FEW BRICKS SHORT OF A LOAD... DA EXPLOSION AT DA TOWER OF SUTHAZE MADE DA SPELL GO PERMANENT, SO WILLIE WILL FOREVER THINK DAT HE IS A DUCK. HE'S HARMLESS, COME TONIGHT WITH ME - YOU WILL SEE!

DON'T GO - HE'S LYIN'! LOOK AT HIM, DA DRAGON TRIED TO FRY HIM.



HERE, TAKE YOUR WEAPON BACK AND DO NOT GET ANY IDEAS ABOUT USING IT.

YEAH, IF ZEY VER SUCH GOOD FRIENDS AND ZEE DRAGON VAS HARMLESS ZEN WHY DID ZE DRAGON ATTACK SNARF?

THE ARGUMENT CONTINUED FOR A WHILE, BUT THE VILLAGERS WERE TOO AFRAID TO GO TO THE RIVER WITH SNARF. FINALLY SNARF GAVE UP AND STARTED VISITING WITH HIS FAMILY AND FRIENDS.



KING OR NOT, IT'S REALLY GOOD TO BE WITH MY FAMILY AN' OL' FRIENDS. HEY, HOW ARE YOU GUYS DOIN'? ETHEAH, DID YOU AN' GEEZEL EVER GET MARRIED?



NO, YOU SEE, GEEZEL FEELS THAT HE SHOULD LEARN MORE MAGIC AND ALSO GET A LITTLE OLDER... THEN WE WILL BE WED.

ME IS JUS' A KID ANYWAY.

AND IT LOOKS LIKE I'M GONNA STAY A RAT... FOREVER. ETHEAH HAS TRIED HER BEST, BUT ONLY OL' SUTHAZE CAN REVERSE THIS SPELL.

WHILE SNARF WAS VISITING NEWFERT WAS MAKING PLANS. LISTEN SNEEVE, WE GOTTA DO SOMETHIN' REALLY SPECIAL TONIGHT CAUSE IT LOOKS LIKE DA VOTE IS SPLIT ABOUT EQUAL.



YEAH, MAYBE I COULD WRITE YOU A GOOD SPEECH...

SURE STUPID! I NEED A SPEECH LIKE I NEED A HOLE IN M' HEAD! HEY... I GOT IT! I'M GONNA BRING DAT STUPID DRAGON RIGHT UP ON STAGE WITH ME!



OK FINE!

YEAH, DAT WOULD SHOW ALL DES MORONS DAT I AM DA BRAVEST OF ALL AN' I'LL SEE DAT WILLIE KEEP HIS MOUTH SHUT ABOUT HIS OL' FRIEND, SNARF.

MEANWHILE, HIGH IN THE SKY.

OH MY, I'M GETTING TOO OLD TO BE A SINGLE GIRL... MY FRIENDS ARE STARTING TO CALL ME AN OLD MAID.



WELL! JUST WET MY EMBERS! THERE SITS A YOUNG MAN RIGHT DOWN IN THAT RIVER.



♪ IT'S NY BIT'S NY STHPIDER WENT UP DA WATER STHPOUT, ♪

HE'S A GOOD LOOKING CHAP.

↓ DOWN CAME DA RAIN AN' WAAAAGGG! A DRAGON!







WHAT'S WRONG WITH YOU, HANDSOME?

EEEE...DONT KILL ME!

HEY, WHO CHAINED YOU UP?



DEM BEINGSTH IN DA VILLAGE UP DER.

MAN, THOSE CRITTERS HAVE YOU REALLY MESSED UP.

I ISTH A DUCK...DO YOU EAT DUCKSTH?

HUMM, THEY HAVE CAST SOME KIND OF DUCK SPELL ON YOU. WAIT HERE, HONEY, I'LL FIX EVERYTHING.

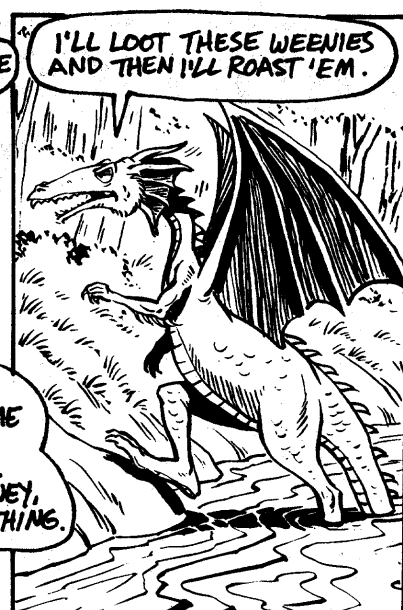

I'LL LOOT THESE WEEENIES AND THEN I'LL ROAST 'EM.



ZE BIG ELECTION BASH IZ 'BOUT TO START.

OKAY, I'LL GO GET DAT STUPID WILLIE. DAT SHOULD KNOCK DA SOCKS OFF OF EVERYBODY.



MINUTES LATER...

WILLIE, HOW DID YOU GET OUTTA YER CHAINS? NEVERMIND, LISTEN, YOU GOTTA ACT LIKE A MEAN DRAGON, AN' DO NOT ACT LIKE YOU KNOW SNARF.

?... SHOULD I EAT THIS TOADSTOOL OR JUS' SEE WHAT THE @\*\* HE'S GONNA DO!



YOU BETTER DO EXACTLY WHAT I SAY OR I'LL FEED YOU TO DA WOLVE'S AN' STUFF A PILLOW WITH YER FEATHERS!

FEATHERS? WHO IS THIS FLAKE?

NOW, FOLLOW ME!



OH LOOK! THERE COMES NEWFERT, LEADING THAT DRAGON...

HE DOESN'T EVEN HAVE A LEASH ON IT.

NEWFERT, DA BRAVE!

NEWFERT, FOR KING!



THIS LOOKS BAD FOR YOU, SNARF, EVEN IF THAT DRAGON IS CRAZY.

YES, THIS IS REALLY GOING TO IMPRESS THE CROWD.



YA KNOW SOMETHIN'? I AM SURE DAT DRAGON IS NOT DA WILLIE DAT WE KNOW... DIS DRAGON LOOKS TOO SMART.

FINAL SHOWDOWN!

# DRAGONMIRTH

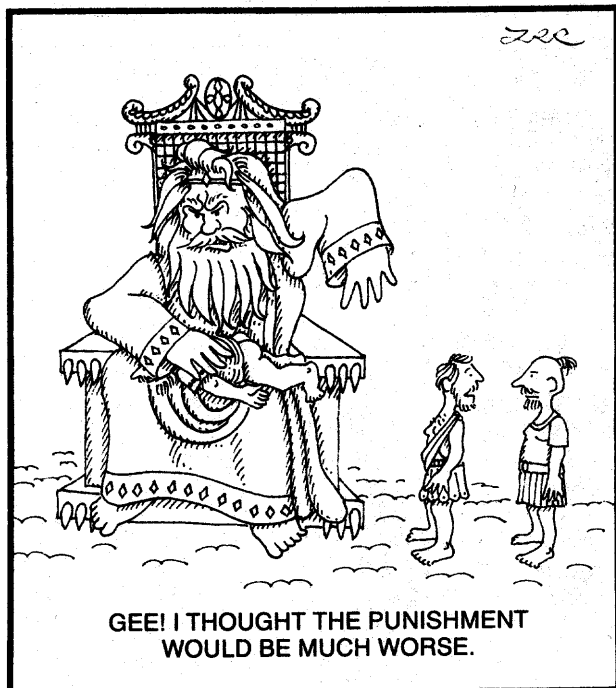

SURE THEY TASTE GOOD,  
BUT TWO HOURS LATER,  
I'M HUNGRY AGAIN.

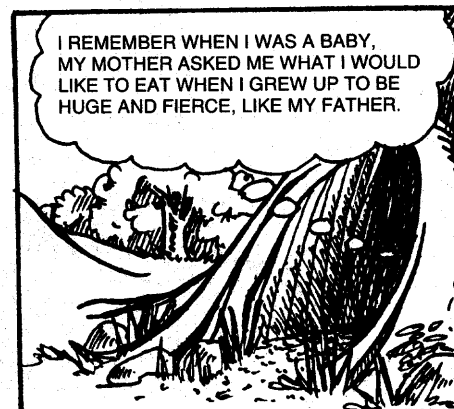
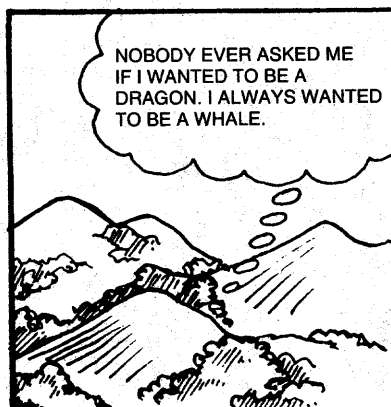

"... OKAY! OKAY! ... IT ONLY TAKES ONE BARBARIAN TO SCREW IN A LIGHT BLUB..."

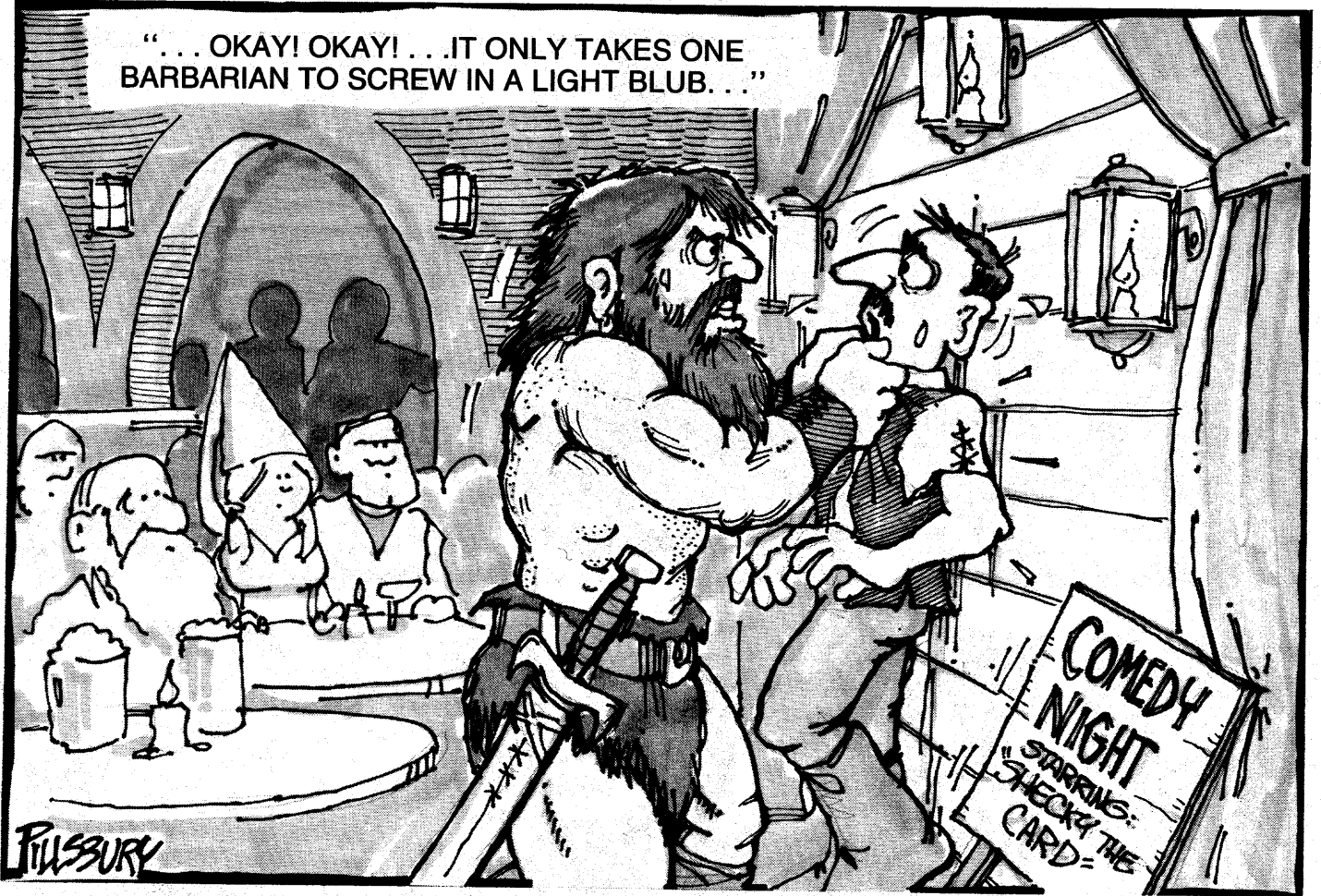

PILSBURY

WHAT IF BATTLES WERE FOUGHT THE WAY THEY ARE PLAYED?

NO! YOU KILL ME! DIDN'T YOU! IT'S I KILLED THE RU! MUST READ ES HERE!

SO WHAT!?! IT'S YOU WHO GOT KILLED! I'M A HIGHER LEVEL THAN YOU!



by FRANKY @MAD-PROS



Samuel

NO KIDDING? ME AND DELBERT ARE BORN-AGAIN ZOMBIES, TOO!

SHE BR I TOLD OKE DOWN AND CRIED WHEN HER, "PLANKTON".



© 1986 2003K COMICS







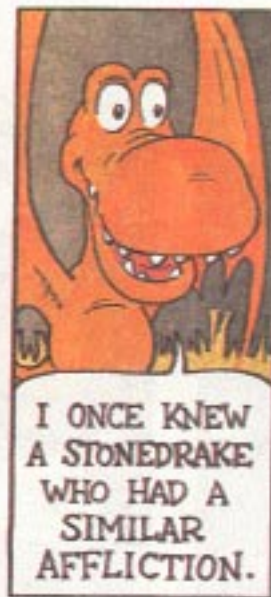







# Shadows in Gotham™



As the sun sets, the shadows grow. As the shops close for the night, the shadows darken. As the businessmen ride the trains to the suburbs, the shadows cover the city.

It is night.

The streetlights wink on. The city is covered by a web of lights.

But it is still night. There are still shadows. Savage people live in the shadows.

Alone, these people of the night are deadly. But they are not alone. They are organized. And at night, the city is theirs.

Or would be, if not for one man:

The Batman™

Welcome to

# NIGHT IN GOTHAM

A  
DC HEROES ROLE-PLAYING  
GAME™ ADVENTURE

By: Mayfair Games Inc.  
P.O. Box 48839  
Niles, IL 60643

MAYFAIR GAMES INC.



\*Indicates Trademark of DC Comics Inc. All character names, renditions, associated slogans, and indicia are trademarks of DC Comics Inc. Copyright ©1986 DC Comics Inc. All rights reserved.

1186-212MFG7.00

Made in USA



NEW FROM IRON CROWN ENTERPRISES!

# Rolemaster Companion™

**THE BEST ROLEPLAYING SYSTEM GETS EVEN BETTER!**

The **ROLEMASTER** system is a complete set of the most advanced, realistic and sophisticated fantasy role playing rules available. The flexibility of the **ROLEMASTER** system allows it to be used wholly or in part. Each of the components can also be used separately to improve the realism of most major FRP systems!

The new **ROLEMASTER COMPANION** expands this classic system with optional rules and guidelines. It provides you with new spell lists and high-level spells. It gives you new character classes and new races. With the **ROLEMASTER COMPANION** you can construct magic items and populate your world with plenty of new creatures! The optional rules also include a fast combat system and numerous game aids to help in running a smooth campaign. The **ROLEMASTER COMPANION** is a must for **ROLEMASTER** and FRP fans!

Distributed to the hobby trade in the U.K. by CHRIS HARVEY GAMES, GAMES ON WHEEL POOL, VIRGIN GAMES & GAMES WORKSHOP LTD. Distributed by JEDDO'S GAME THE ALBANS, BLACKWOOD GAYLE in New Zealand, TARGET GAMES AB in Sweden, GAMES DEL in West Germany, PAVI in Denmark, ITALIA GAMES, SPA FOSI in Italy, and I.T.W. in Japan.

IRON CROWN ENTERPRISES / P.O. BOX 1605 / CHARLOTTESVILLE, VA 22902



**I.C.E.**

- PLEASE RUSH ME: U.S. \$
- SPELL LAW ..... \$12.00
  - ARMS LAW & CLAW LAW ..... \$12.00
  - CHARACTER & CAMPAIGN LAW ..... \$12.00
  - ROLEMASTER BOX (includes all of the above) ..... \$34.00
  - CREATURES & TREASURES ..... \$12.00
  - ROLEMASTER COMPANION ..... \$12.00

NAME \_\_\_\_\_

STREET \_\_\_\_\_

CITY \_\_\_\_\_ STATE \_\_\_\_\_ ZIP \_\_\_\_\_

PHONE \_\_\_\_\_

Orders up to \$49.95 add \$1.25 postage & handling, orders of \$50.00 or more add \$2.50. Canadians add (U.S.) \$2.50 on all orders. Send check or money order, no cash or COD. VISA & MASTERCARD orders call (800) 325-0479. VA residents, Canadians & overseas customers call (804) 295-3917. Please make phone orders during normal business hours 9AM-5PM, Eastern Standard Time, Mon.-Fri.

Copyright 1986 IRON CROWN ENTERPRISES, INC.,



